

# Photometric Test Report



## ECLDISPLAYDAT

ZOOMABLE PROFILE LENS 20-40°

25W White LED gallery light, with data control

DMX / Dali / Knob-dimming

## CONTENTS

Table of contents	2
Testing process	3
Color temperature 2700K Max Zoom	4
Color temperature 2700K Min Zoom	9
Color temperature 3000K Max Zoom	14
Color temperature 3000K Min Zoom	19
Color temperature 4000K Max Zoom	24
Color temperature 4000K Min Zoom	29
Color temperature 5600K Max Zoom	34
Color temperature 5600K Min Zoom	39

## TESTING PROCESS

Prolights has its own optical testing laboratory in order to provide accurate photometric reports for its lighting products. The testing laboratory contains certain variety of precise lighting measurement systems that ensure an optimal reading of all the characteristic parameters of the lighting devices. All measurements are made at a controlled room temperature of 20°C without any external light sources. This photometric report is obtained through the data measured by a high precision measurement system and analyzed by a dedicate software.

### **Prolights measurement instrument**

Prolights measurement instrument is a complete measurement system for any light source. It's equipped with two-axis goniometer, that enables to measure the full 3D distribution field of the light source. This instrument measures the light intensity, the beam angle and the most significative colors parameters, like color temperature, spectral distribution, CRI, CQS, TM-30 with a very high accuracy rate.

**Please Note:** All measurements are made with light source at operating temperature. Before starting the measurement, the instrument analyzes the process of the light source during the heating phase. The measuring process of all the parameters begins only when the light emission is stable, that is with a variation of less than 0.5% in a 15 minutes time frame.

### **Prolights measurement software**

The software provides user friendly interface for the operator who does the measurements, and it also analyzes and processes all the collected data by the instrument. With this software it is possible to see the measured data in real-time and it is possible to examine all the measured data and graphics afterwards as well. All information is collected in a specific Prolights template, and the software creates also IES and LDT files, which are widely used to transfer the photometric data, and to develop lighting system.

Additionally, the fixtures are rechecked using various hand-held instruments like Sekonic C-700 and Gossen Mavospec Base, this is done to ensure, that the data in the photometric report are as accurate as possible.



Total lumen output:

1586 lm

Peak candela output:

5528 cd

Light quality:

CRI: 90,4

Color temperature:

2879 K

PRODUCT NAME:

ECLDISPLAY

MEASURAMENT CONDITIONS:

Beam angle:

Profile Max Zoom

Target:

2700K

Operator:

Paolo Carvone

Date and time:

21/09/2020 18:02:06

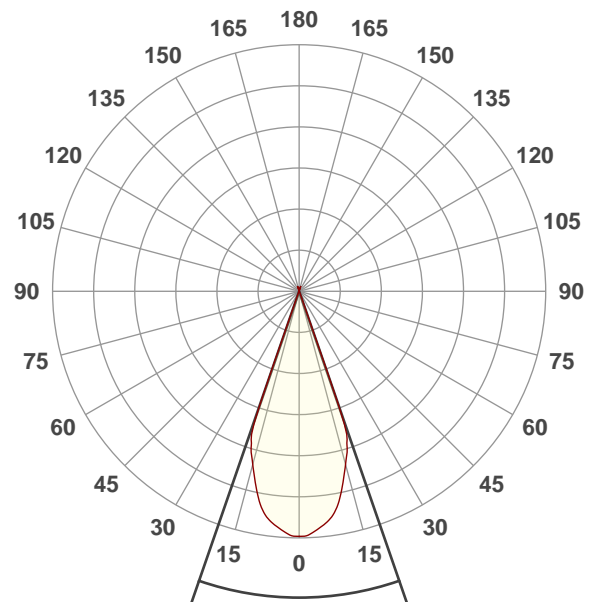

Beam angle 50%: 38,1°

Field angle 10%: 40,8°

Cut off angle 2.5%: 41,3°

Spectra

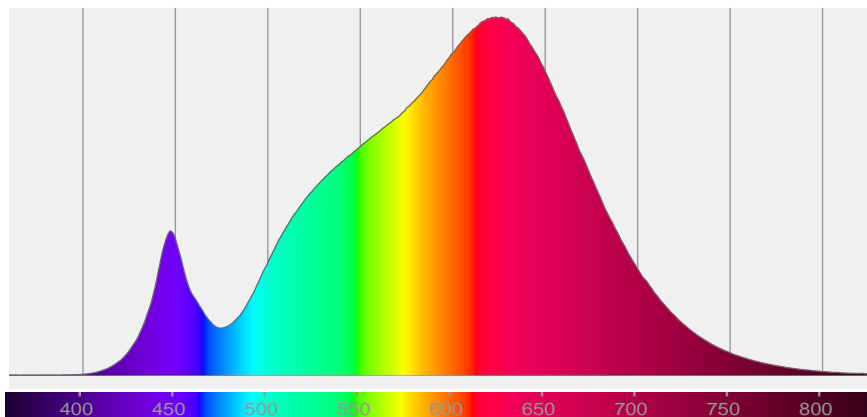

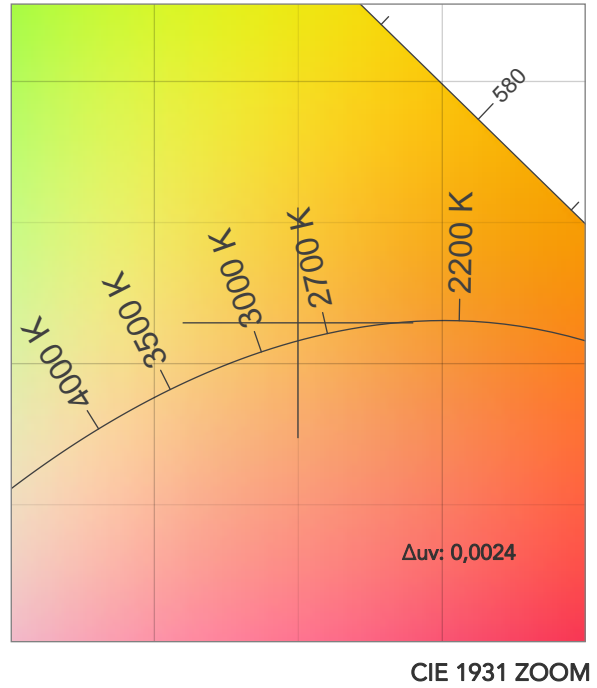
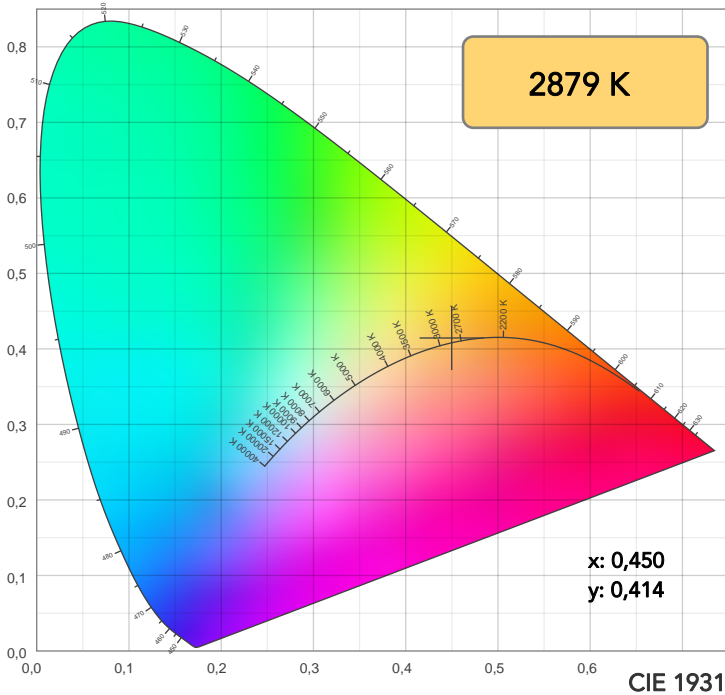

TM30: 89,2

CRI: 90,4 (R1-R8)

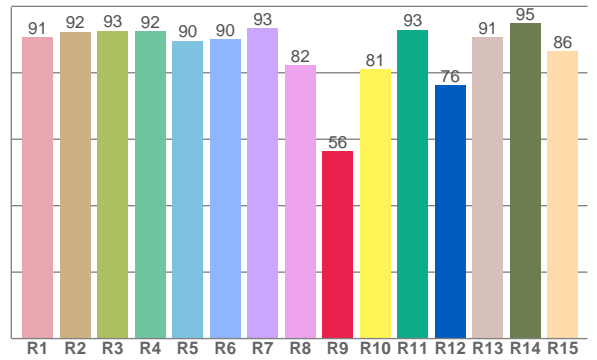
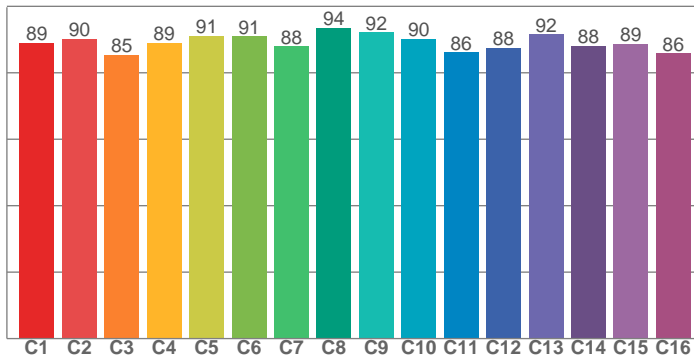

CRI R values, only R1-R8 are used to calculate final CRI value

R1	R2	R3	R4	R5	R6	R7	R8	R9	R10	R11	R12	R13	R14	R15
90,8	92,3	92,6	92,4	89,6	90,2	93,3	82,3	56,3	81,1	93,0	76,2	90,8	95,0	86,5

TM30 C values, 16 binned values out of total of 99 C values

C1	C2	C3	C4	C5	C6	C7	C8	C9	C10	C11	C12	C13	C14	C15	C16
88,9	90,2	85,5	89,0	91,0	91,0	87,9	93,5	92,2	90,3	86,2	87,6	91,5	88,2	88,7	85,8

CQS Q values

Q1	Q2	Q3	Q4	Q5	Q6	Q7	Q8	Q9	Q10	Q11	Q12	Q13	Q14	Q15
86,3	96,7	87,2	88,0	88,6	86,8	88,6	92,7	96,0	91,7	91,3	91,8	92,0	85,1	85,5

CQS: 89,2

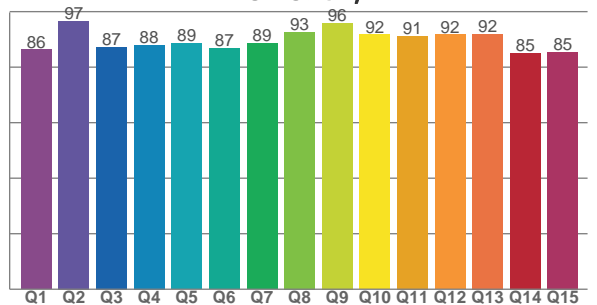

COLOR PARAMETERS

Color temperature	Color rendering index	Red component	Color fidelity	Color gamut	Color quality scale	Television lighting index	Color coordinate cie 1931	Color coordinate cie 1931	Color deviation from black body
CCT	CRI	CRI R9	TM30 Rf	TM30 Rg	CQS	TLCI	x	y	Δuv
2879 K	90,4	56,3	89,2	100,6	89,2	87	0,450	0,414	0,0024

# TM30 DETAILS

**Rf 89,2**  
Fidelity index Rf

**Rg 100,6**  
Gammut index

Hue Bin	R <sub>f</sub>	Graphic shifts (%)	
		Chroma	Hue
1	89	-5%	-2%
2	90	-4%	3%
3	85	-2%	7%
4	89	2%	6%
5	91	4%	5%
6	91	5%	0%
7	88	2%	-7%
8	94	0%	-4%
9	92	-3%	-2%
10	90	-5%	3%
11	86	-2%	8%
12	88	4%	4%
13	92	5%	-2%
14	88	5%	-6%
15	89	1%	-6%
16	86	-2%	-10%

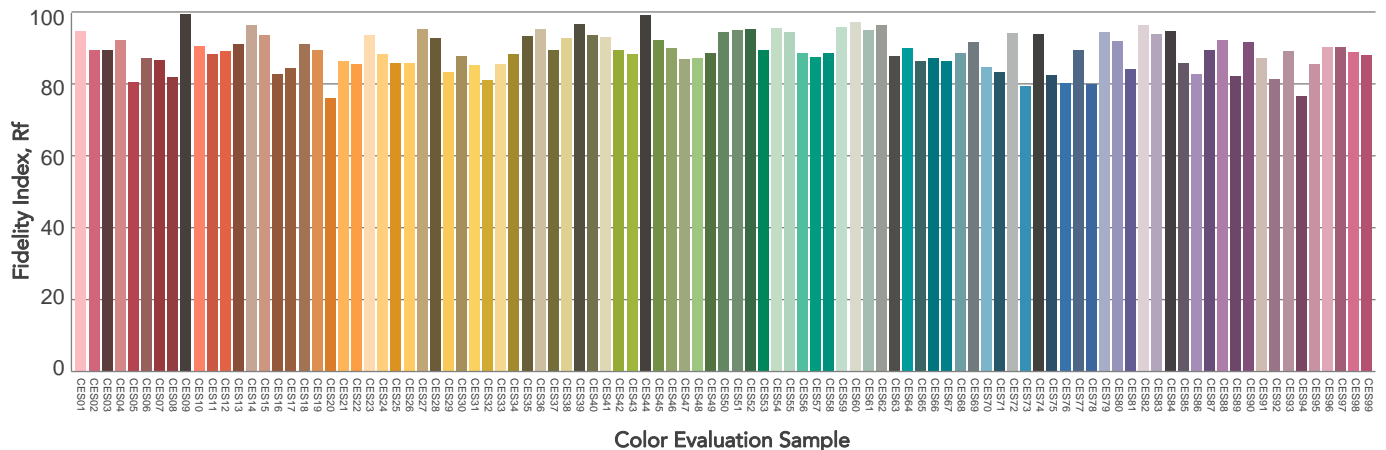
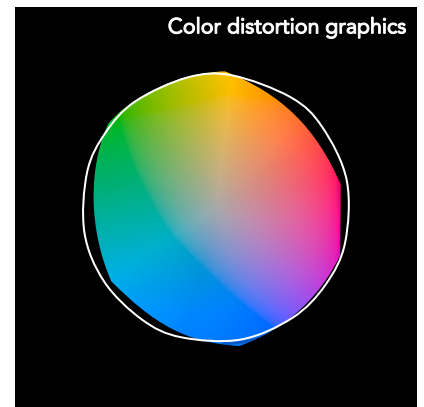
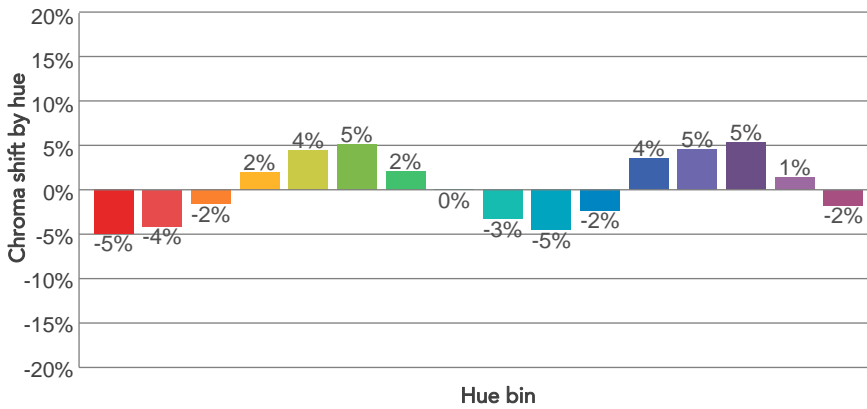
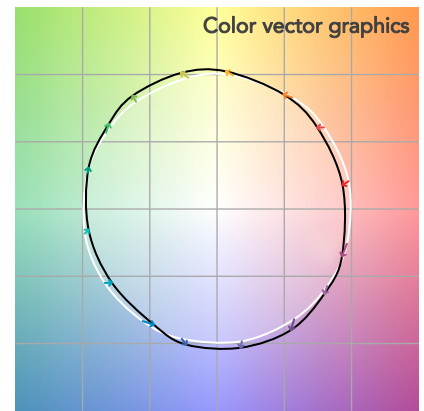
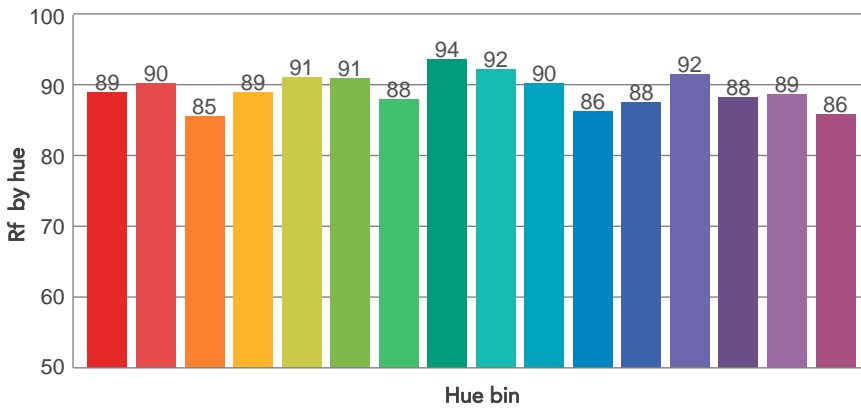
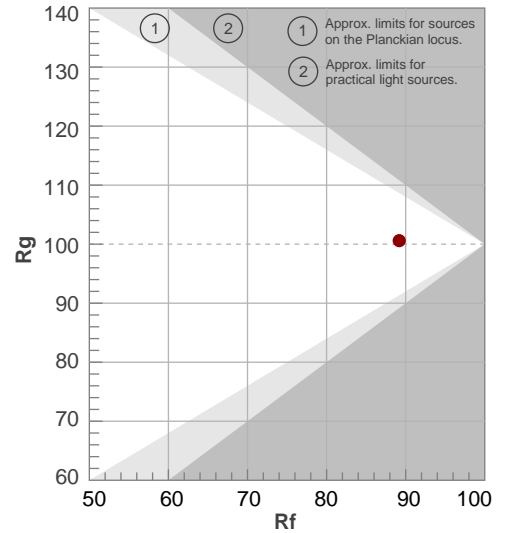

# BEAM DETAILS



Beam angle 50%	Field angle 10%	Cut off angle 2,5%	Intensity ratio in 120° cone	Intensity ratio in 90° cone
38,1°	40,8°	41,3°	99,9%	99,9%

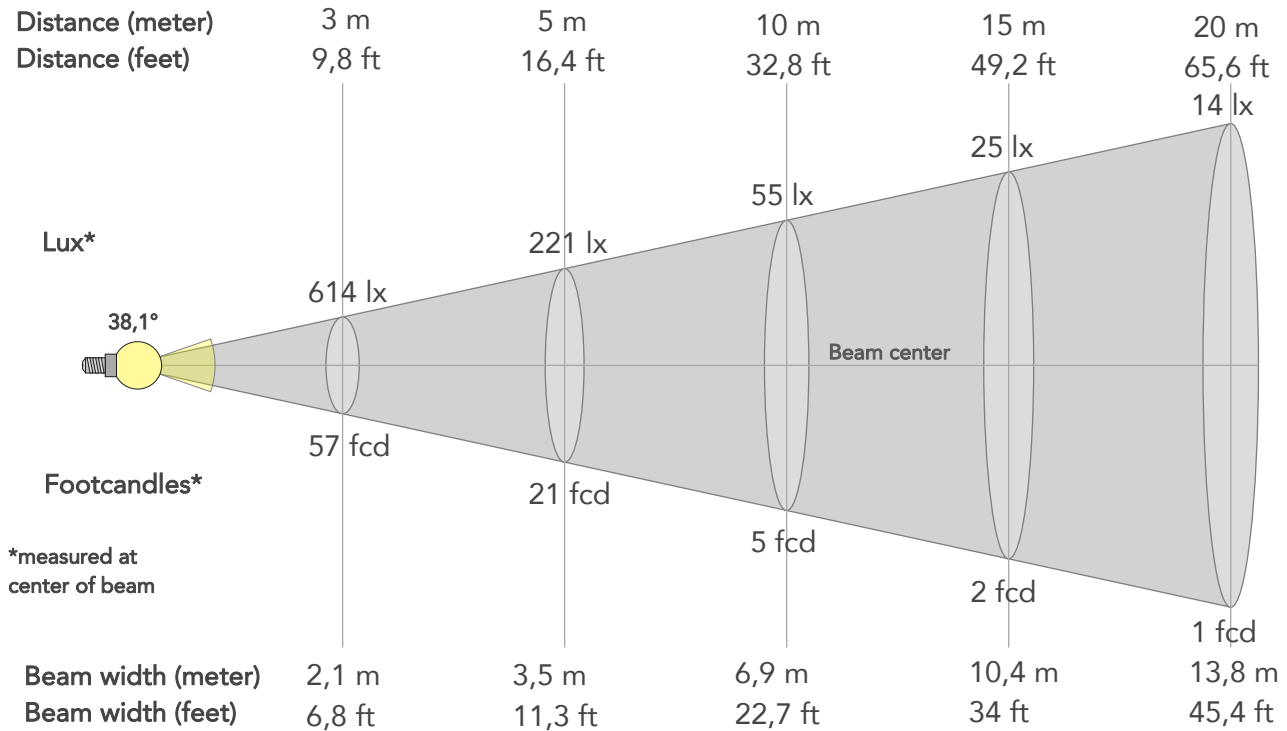

## BEAM INTENSITIES AND WIDTHS

Distance	1m	2m	3m	4m	5m	7,5m	10m	15m	20m	25m	30m	40m	50m
Distance	3,3ft	6,6ft	9,8ft	13,1ft	16,4ft	24,6ft	32,8ft	49,2ft	65,6ft	82ft	98,4ft	131,2ft	164ft
Lux	5528lx	1382lx	614lx	345lx	221lx	98lx	55lx	25lx	14lx	9lx	6lx	3lx	2lx
Footcand.	514fcd	128fcd	57fcd	32fcd	21fcd	9fcd	5fcd	2fcd	1fcd	1fcd	1fcd	0fcd	0fcd
Beam wid.	0,7m	1,4m	2,1m	2,8m	3,5m	5,2m	6,9m	10,4m	13,8m	17,3m	20,7m	27,7m	34,6m
Beam wid.	2,3ft	4,6ft	6,8ft	9,1ft	11,3ft	17ft	22,7ft	34ft	45,4ft	56,7ft	68ft	90,7ft	113,4ft

## LINEAR DISTRIBUTION DIAGRAM

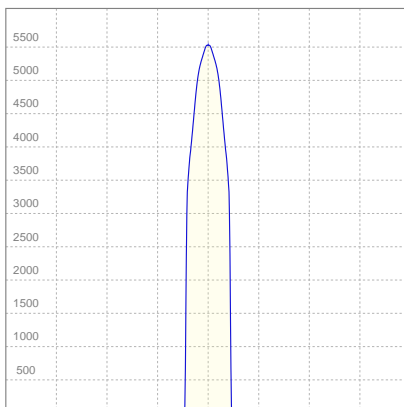

## ELECTRICAL SPECIFICATIONS

Input voltage	Input current	Input power	Effeciency
225V	0,172A	35,0W	45lm/W
Power Fc			
0,94			

## ISO CANDELA DIAGRAM

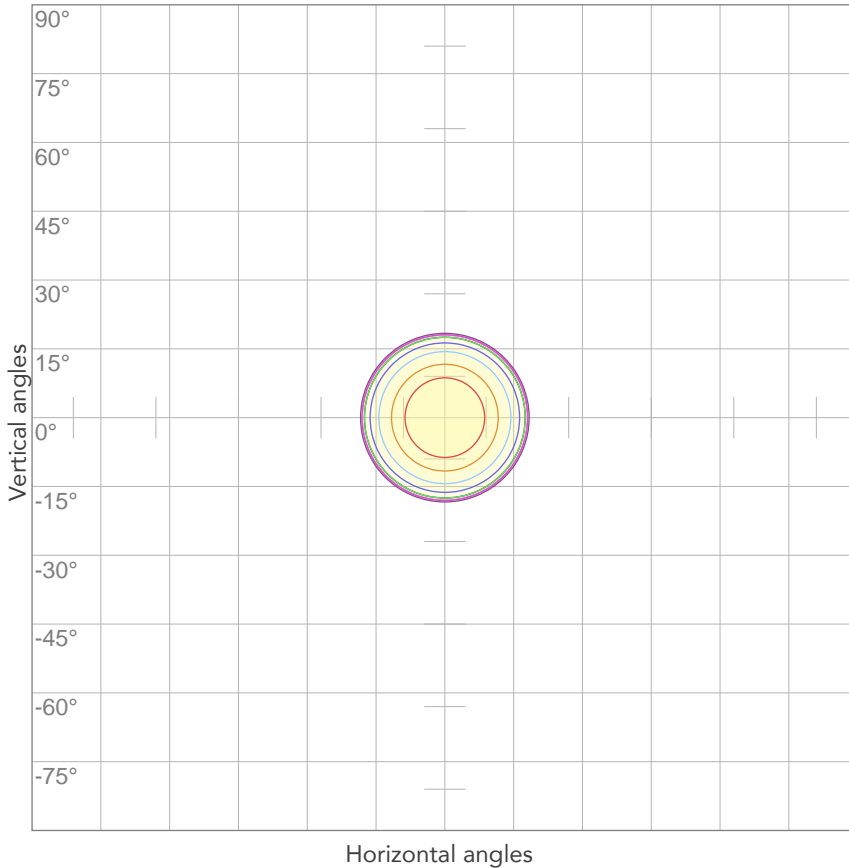

10%	553 cd
20%	1106 cd
30%	1658 cd
40%	2211 cd
50%	2764 cd
60%	3317 cd
70%	3869 cd
80%	4422 cd

Conditions:

Number of c-planes: 2

Candela at center: 5528 cd

## ISO LUX DIAGRAM

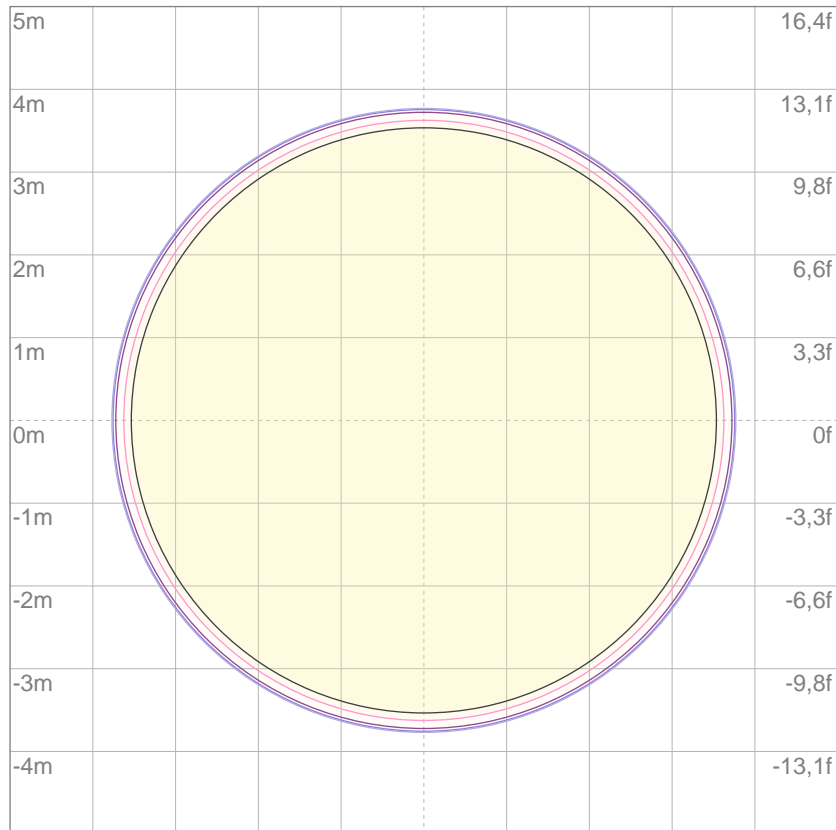

3%	1,66 lx
5%	2,76 lx
10%	5,53 lx
30%	16,6 lx
50%	27,6 lx

Conditions:

Number of c-planes: 2

Lux at center: 55,3 lx

*Lux distribution on a surface when lamp is mounted at 10 meters from the surface.*

Mounting height: 10 meters (33 feet)





Total lumen output:

1498 lm

Peak candela output:

20619 cd

Light quality:

CRI: 90,5

Color temperature:

2867 K

PRODUCT NAME:

ECLDISPLAY

MEASURAMENT CONDITIONS:

Beam angle:

Profile Min Zoom

Target:

2700K

Operator:

Paolo Carvone

Date and time:

21/09/2020 18:04:49

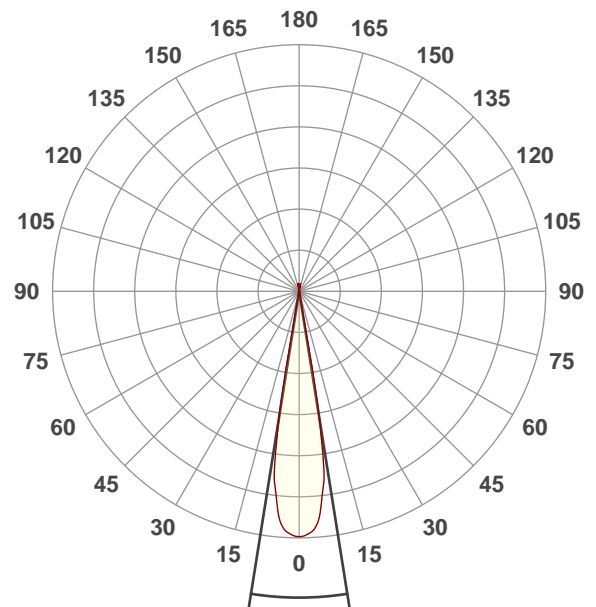

Beam angle 50%: 18,1°

Field angle 10%: 21°

Cut off angle 2.5%: 21,5°

Spectra

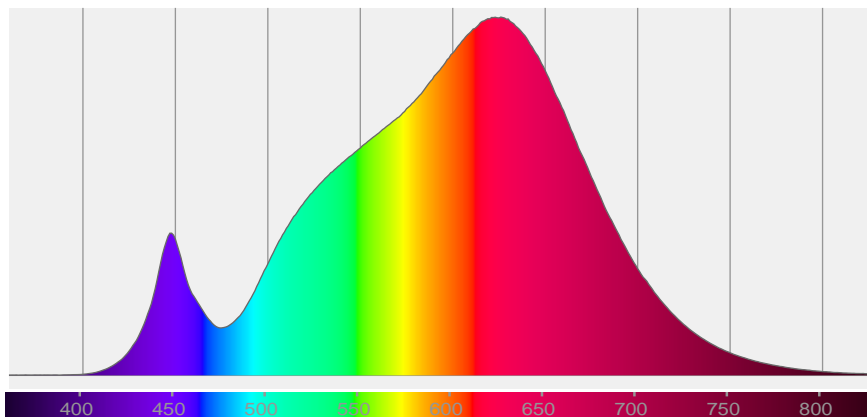

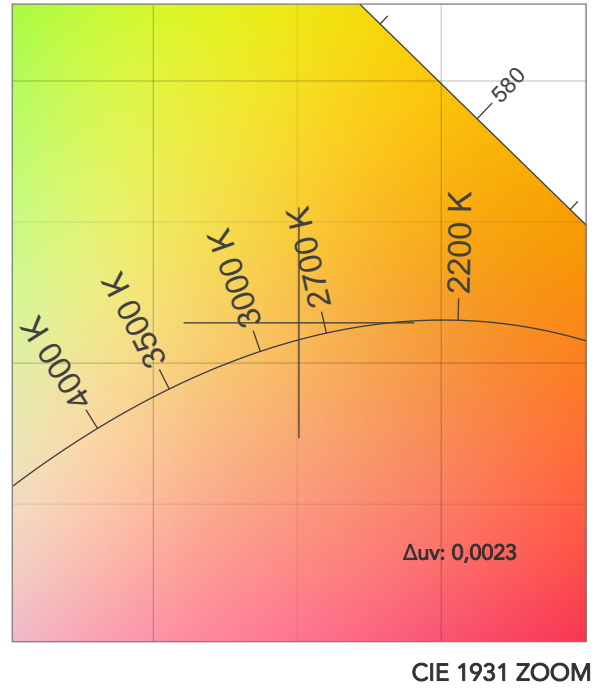
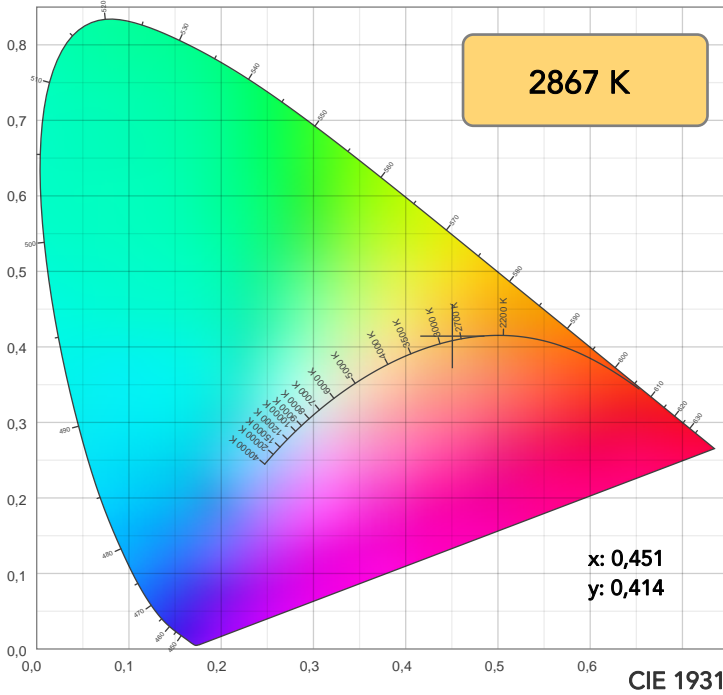

TM30: 89,2

CRI: 90,5 (R1-R8)

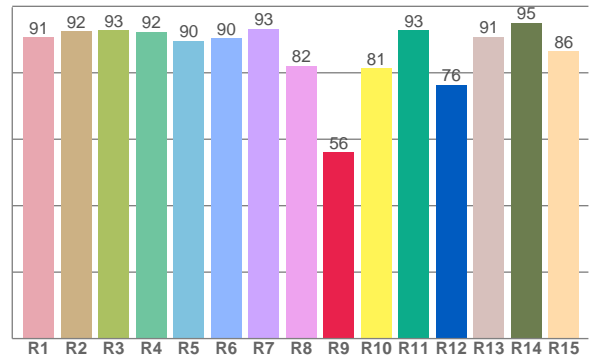
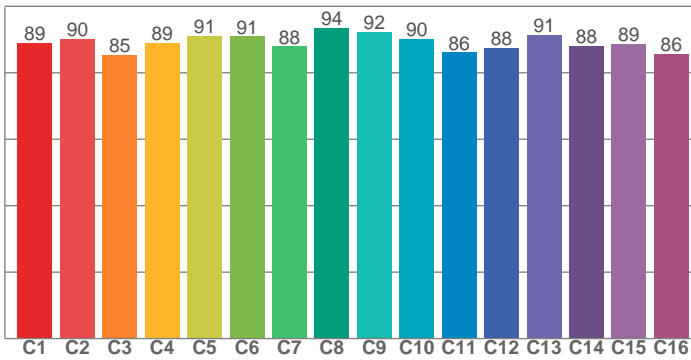

CRI R values, only R1-R8 are used to calculate final CRI value

R1	R2	R3	R4	R5	R6	R7	R8	R9	R10	R11	R12	R13	R14	R15
90,8	92,4	92,8	92,4	89,6	90,3	93,3	82,1	56,2	81,3	92,9	76,4	90,8	95,0	86,5

TM30 C values, 16 binned values out of total of 99 C values

C1	C2	C3	C4	C5	C6	C7	C8	C9	C10	C11	C12	C13	C14	C15	C16
88,9	90,2	85,4	89,0	91,1	91,0	88,0	93,5	92,3	90,3	86,2	87,6	91,5	88,1	88,7	85,8

CQS Q values

Q1	Q2	Q3	Q4	Q5	Q6	Q7	Q8	Q9	Q10	Q11	Q12	Q13	Q14	Q15
86,3	96,7	87,2	87,9	88,6	86,8	88,5	92,6	96,0	91,7	91,3	91,8	91,9	85,0	85,4

CQS: 89,1

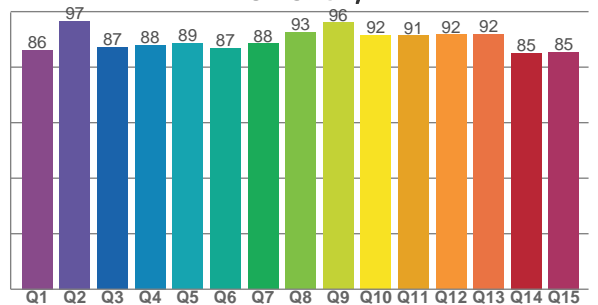

COLOR PARAMETERS

Color temperature	Color rendering index	Red component	Color fidelity	Color gamut	Color quality scale	Television lighting index	Color coordinate cie 1931	Color coordinate cie 1931	Color deviation from black body
CCT	CRI	CRI R9	TM30 Rf	TM30 Rg	CQS	TLCI	x	y	$\Delta uv$
2867 K	90,5	56,2	89,2	100,6	89,1	87	0,451	0,414	0,0023

# TM30 DETAILS

**Rf 89,2**  
Fidelity index Rf

**Rg 100,6**  
Gammut index

Hue Bin	R <sub>f</sub>	Graphic shifts (%)	
		Chroma	Hue
1	89	-5%	-2%
2	90	-4%	3%
3	85	-2%	7%
4	89	2%	6%
5	91	4%	5%
6	91	5%	0%
7	88	2%	-7%
8	94	0%	-4%
9	92	-3%	-2%
10	90	-5%	3%
11	86	-2%	8%
12	88	4%	4%
13	91	5%	-2%
14	88	5%	-6%
15	89	1%	-6%
16	86	-2%	-10%

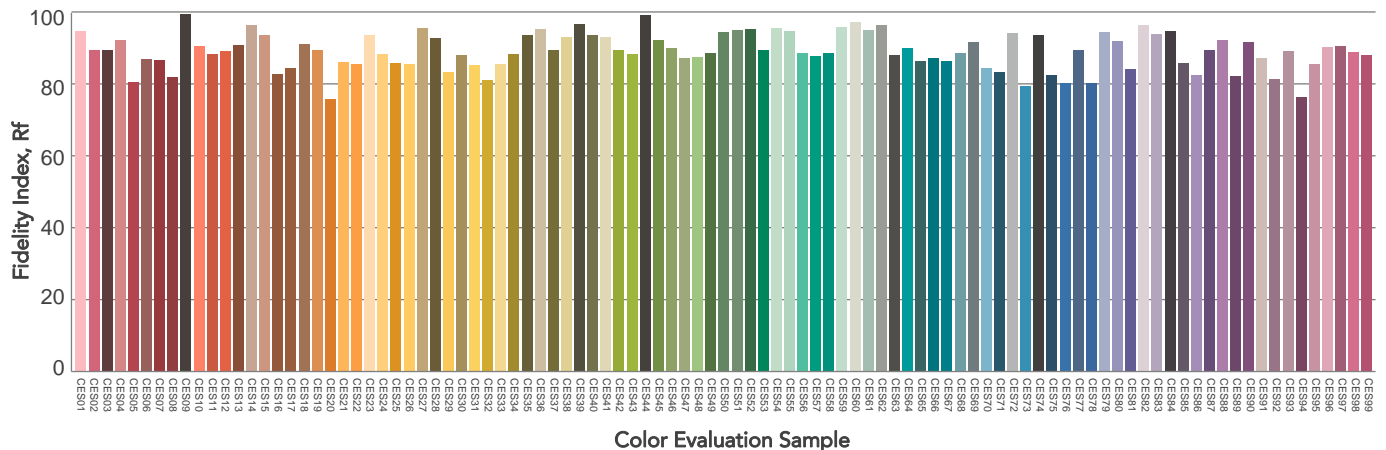
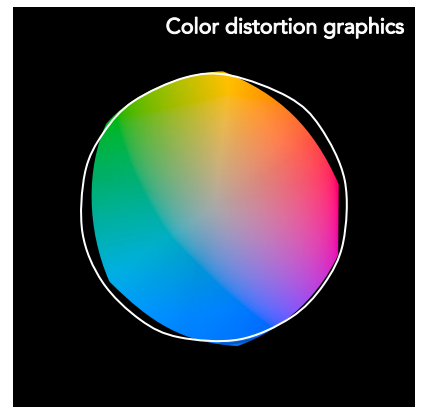
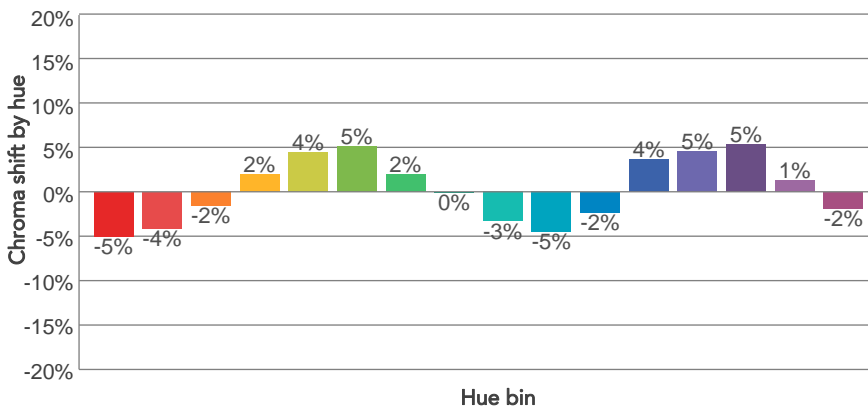
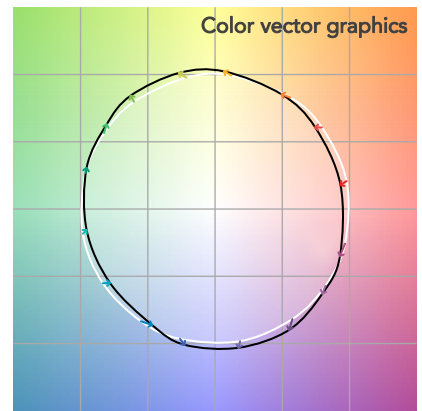
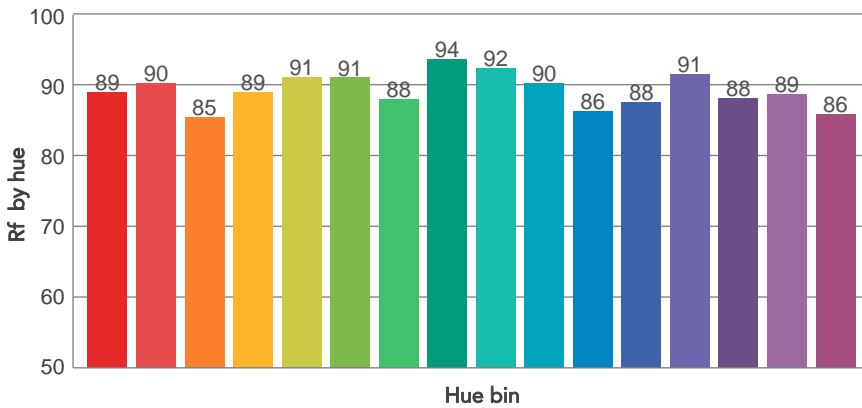
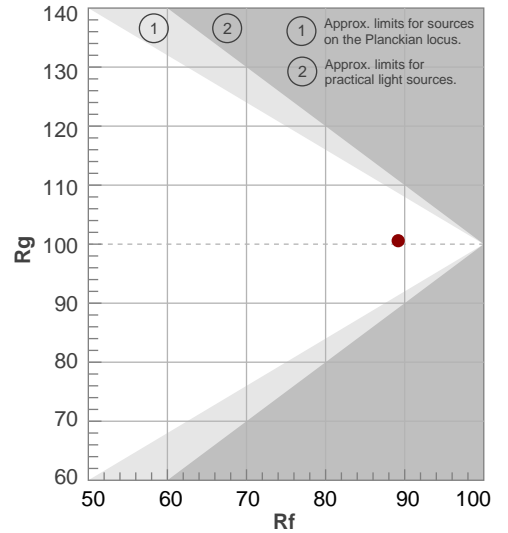

# BEAM DETAILS



Beam angle 50%	Field angle 10%	Cut off angle 2,5%	Intensity ratio in 120° cone	Intensity ratio in 90° cone
18,1°	21°	21,5°	100,0%	100,0%

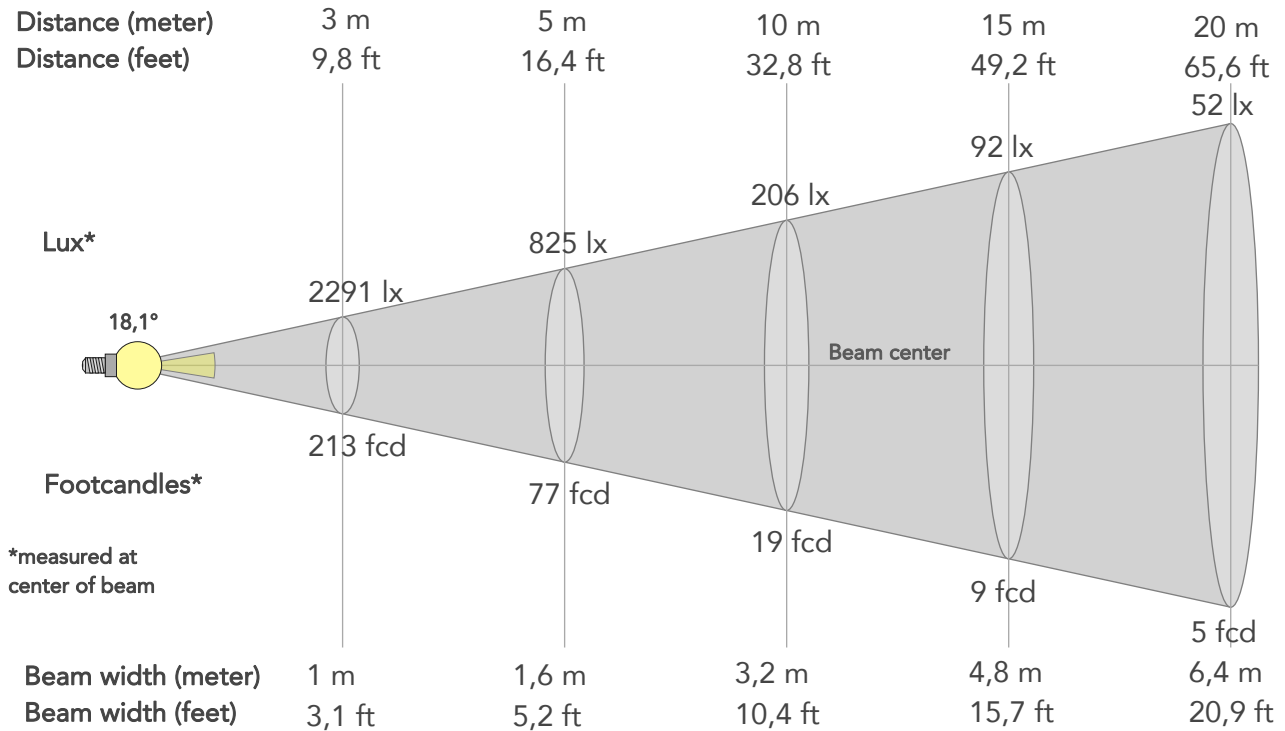

## BEAM INTENSITIES AND WIDTHS

Distance	1m	2m	3m	4m	5m	7,5m	10m	15m	20m	25m	30m	40m	50m
Distance	3,3ft	6,6ft	9,8ft	13,1ft	16,4ft	24,6ft	32,8ft	49,2ft	65,6ft	82ft	98,4ft	131,2ft	164ft
Lux	20619lx	5155lx	2291lx	1289lx	825lx	367lx	206lx	92lx	52lx	33lx	23lx	13lx	8lx
Footcand.	1916fcd	479fcd	213fcd	120fcd	77fcd	34fcd	19fcd	9fcd	5fcd	3fcd	2fcd	1fcd	1fcd
Beam wid.	0,3m	0,6m	1m	1,3m	1,6m	2,4m	3,2m	4,8m	6,4m	8m	9,6m	12,7m	15,9m
Beam wid.	1,1ft	2,1ft	3,1ft	4,2ft	5,2ft	7,8ft	10,4ft	15,7ft	20,9ft	26,1ft	31,3ft	41,8ft	52,2ft

## LINEAR DISTRIBUTION DIAGRAM

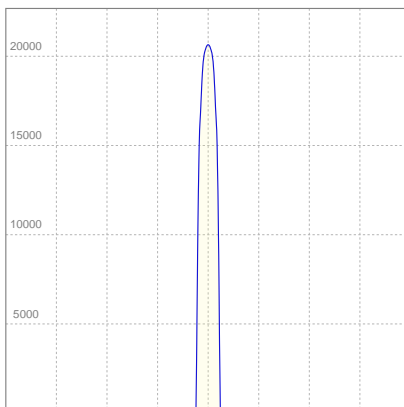

## ELECTRICAL SPECIFICATIONS

Input voltage	Input current	Input power	Effeciency
225V	0,171A	34,8W	43lm/W

Power Fc
0,94

## ISO CANDELA DIAGRAM

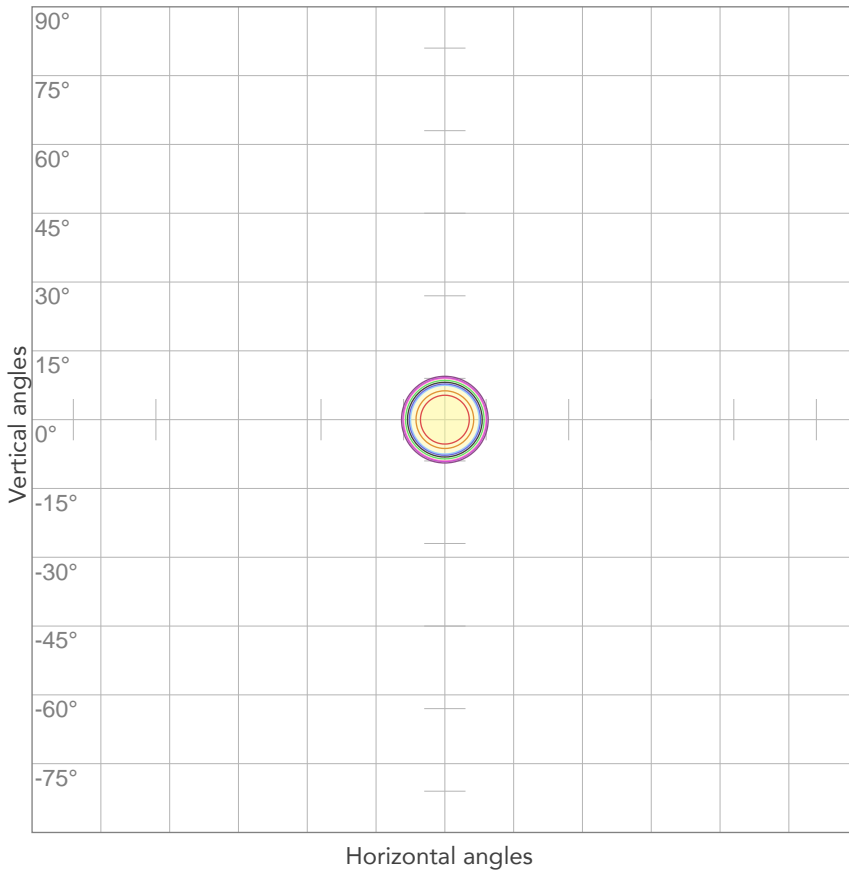

10%	2062 cd
20%	4124 cd
30%	6186 cd
40%	8247 cd
50%	10309 cd
60%	12371 cd
70%	14433 cd
80%	16495 cd

Conditions:

Number of c-planes: 2

Candela at center: 20619 cd

## ISO LUX DIAGRAM

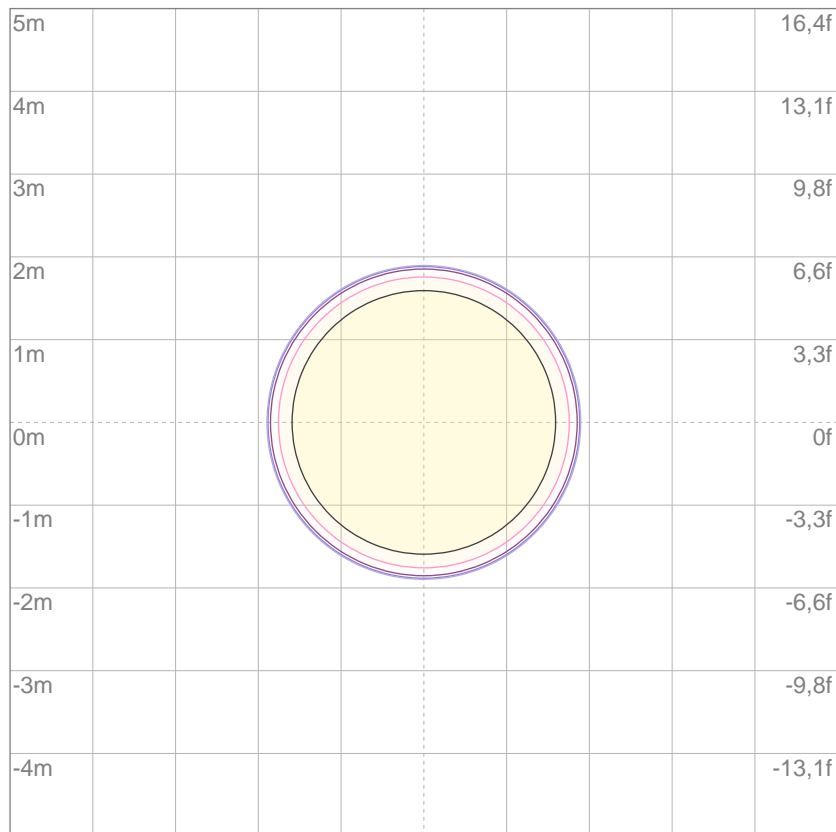

3%	6,19 lx
5%	10,3 lx
10%	20,6 lx
30%	61,9 lx
50%	103 lx

Conditions:

Number of c-planes: 2

Lux at center: 206 lx

*Lux distribution on a surface when lamp is mounted at 10 meters from the surface.*

Mounting height: 10 meters (33 feet)



Total lumen output:

1676 lm

Peak candela output:

6028 cd

Light quality:

CRI: 90,0

Color temperature:

3035 K

**PRODUCT NAME:**

**ECLDISPLAY**

**MEASURAMENT CONDITIONS:**

Beam angle:

Profile Max Zoom

Target:

3000K

Operator:

Paolo Carvone

Date and time:

22/09/2020 09:33:28

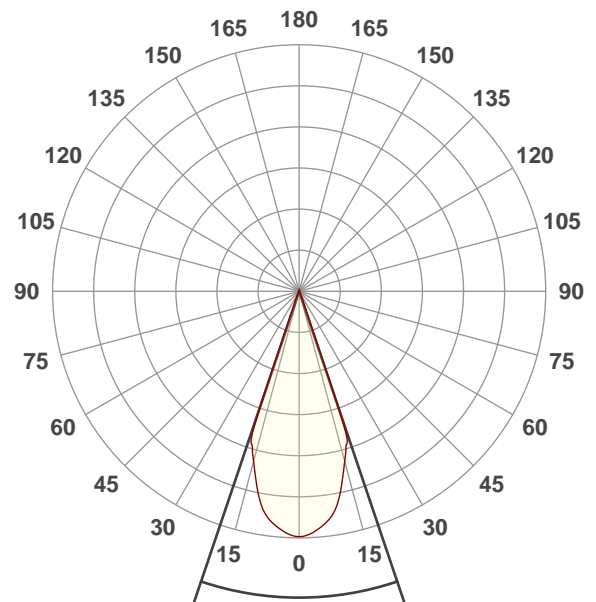

Beam angle 50%: 37,3°

Field angle 10%: 40,2°

Cut off angle 2.5%: 42,8°

Spectra

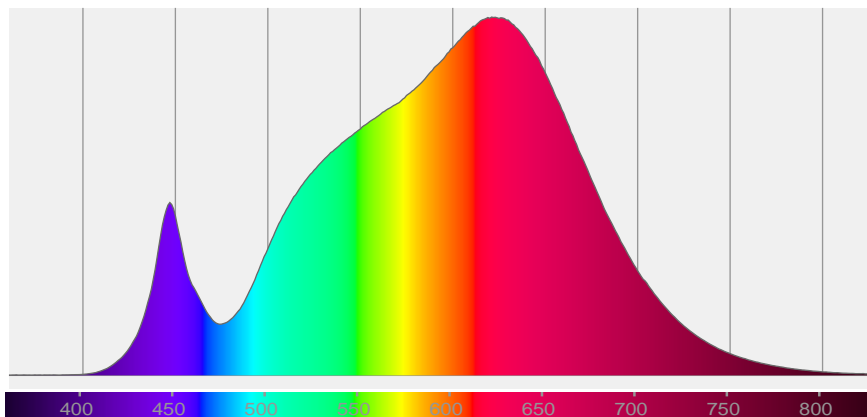

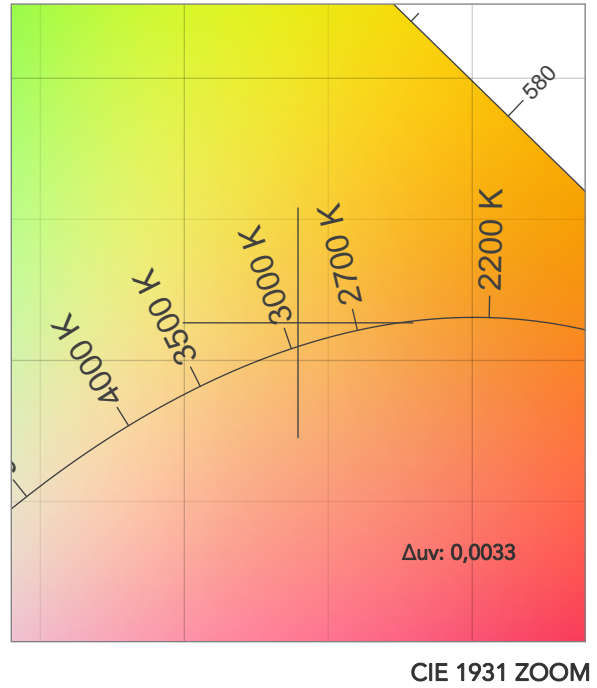
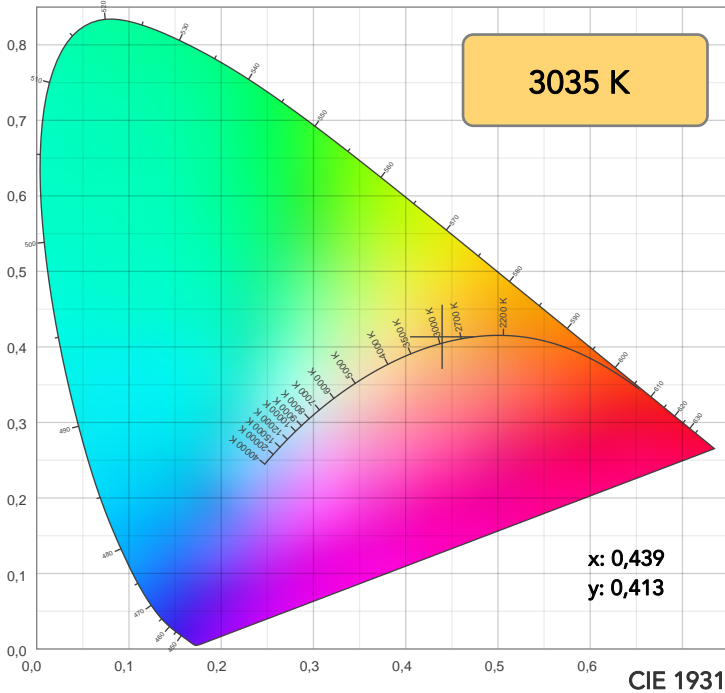

TM30: 89,1

CRI: 90,0 (R1-R8)

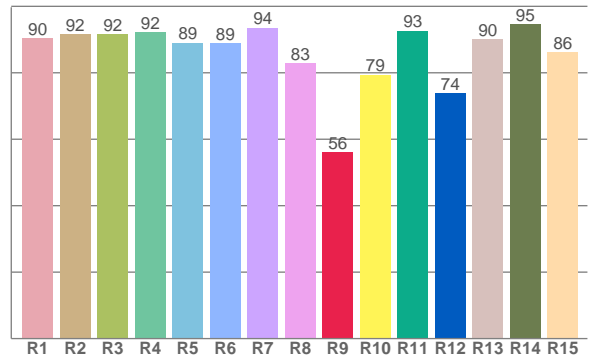
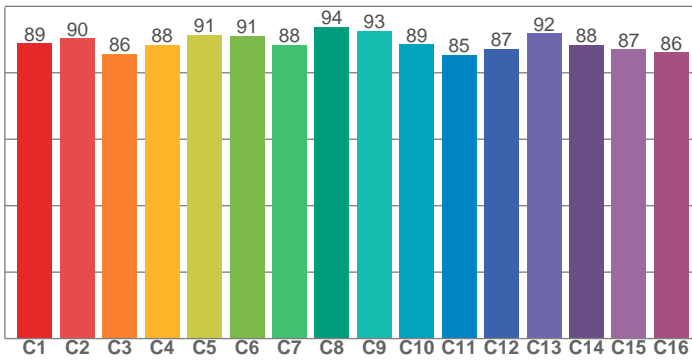

CRI R values, only R1-R8 are used to calculate final CRI value

R1	R2	R3	R4	R5	R6	R7	R8	R9	R10	R11	R12	R13	R14	R15
90,3	91,5	91,7	92,3	89,1	88,9	93,6	82,9	56,1	79,4	92,7	73,9	90,1	94,5	86,1

TM30 C values, 16 binned values out of total of 99 C values

C1	C2	C3	C4	C5	C6	C7	C8	C9	C10	C11	C12	C13	C14	C15	C16
88,9	90,4	85,6	88,3	91,5	91,2	88,4	93,9	92,6	88,6	85,3	87,2	91,8	88,3	87,0	86,1

CQS Q values

Q1	Q2	Q3	Q4	Q5	Q6	Q7	Q8	Q9	Q10	Q11	Q12	Q13	Q14	Q15
87,0	97,1	86,8	87,7	88,6	86,9	89,1	93,4	95,8	91,7	91,0	91,7	92,1	85,2	85,8

CQS: 89,3

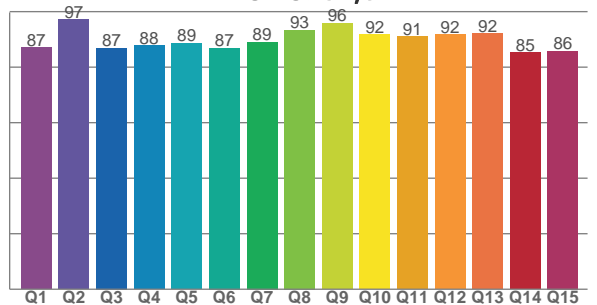

COLOR PARAMETERS

Color temperature	Color rendering index	Red component	Color fidelity	Color gamut	Color quality scale	Television lighting index	Color coordinate cie 1931	Color coordinate cie 1931	Color deviation from black body
CCT	CRI	CRI R9	TM30 Rf	TM30 Rg	CQS	TLCI	x	y	Δuv
3035 K	90,0	56,1	89,1	100,5	89,3	88	0,439	0,413	0,0033

# TM30 DETAILS

**Rf 89,1**  
Fidelity index Rf

**Rg 100,5**  
Gammut index

Hue Bin	R <sub>f</sub>	Graphic shifts (%)	
		Chroma	Hue
1	89	-5%	-2%
2	90	-4%	3%
3	86	-2%	6%
4	88	2%	6%
5	91	3%	5%
6	91	5%	0%
7	88	2%	-6%
8	94	0%	-4%
9	93	-4%	-2%
10	89	-5%	3%
11	85	-2%	9%
12	87	4%	5%
13	92	4%	-1%
14	88	6%	-6%
15	87	2%	-7%
16	86	-1%	-10%

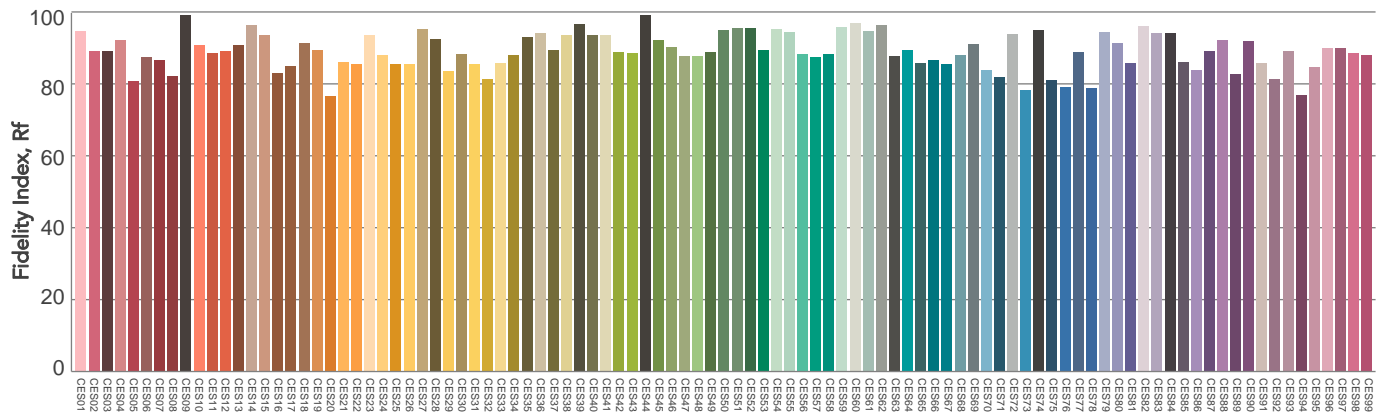
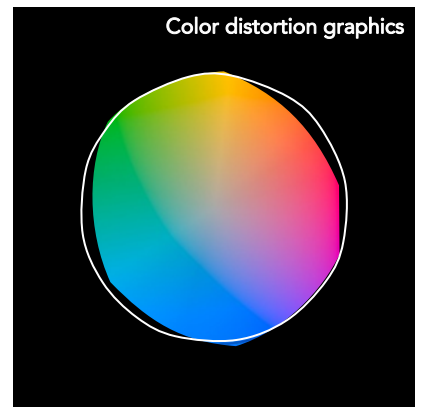
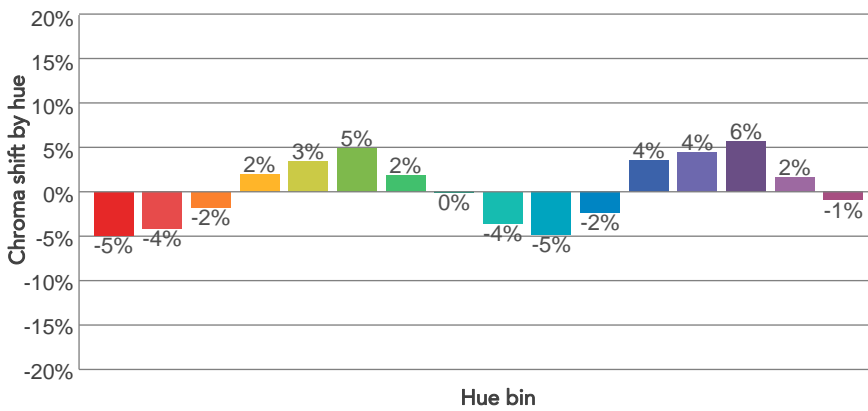
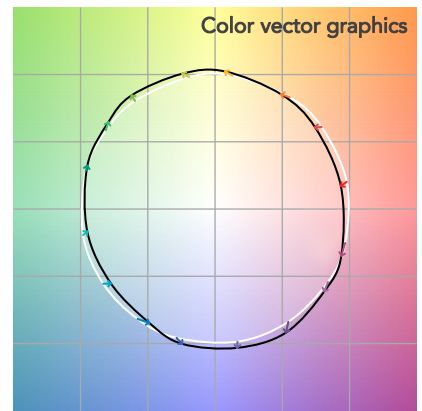
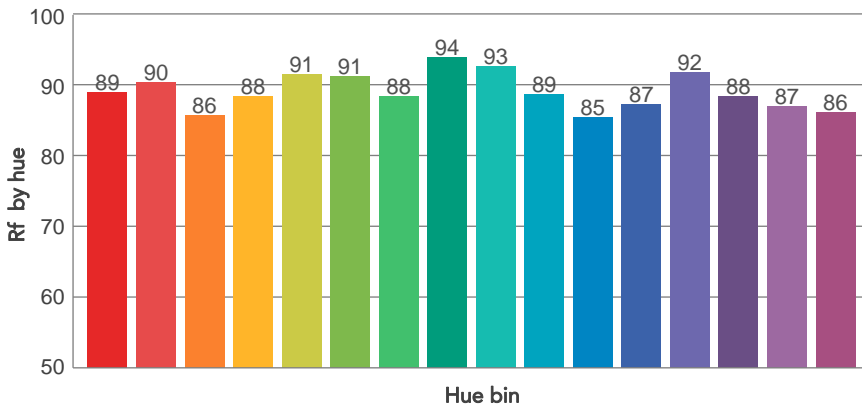
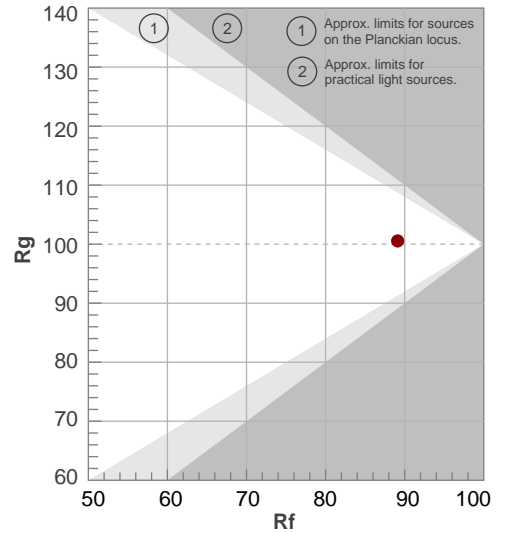



# BEAM DETAILS



Beam angle 50%	Field angle 10%	Cut off angle 2,5%	Intensity ratio in 120° cone	Intensity ratio in 90° cone
37,3°	40,2°	42,8°	100,0%	100,0%

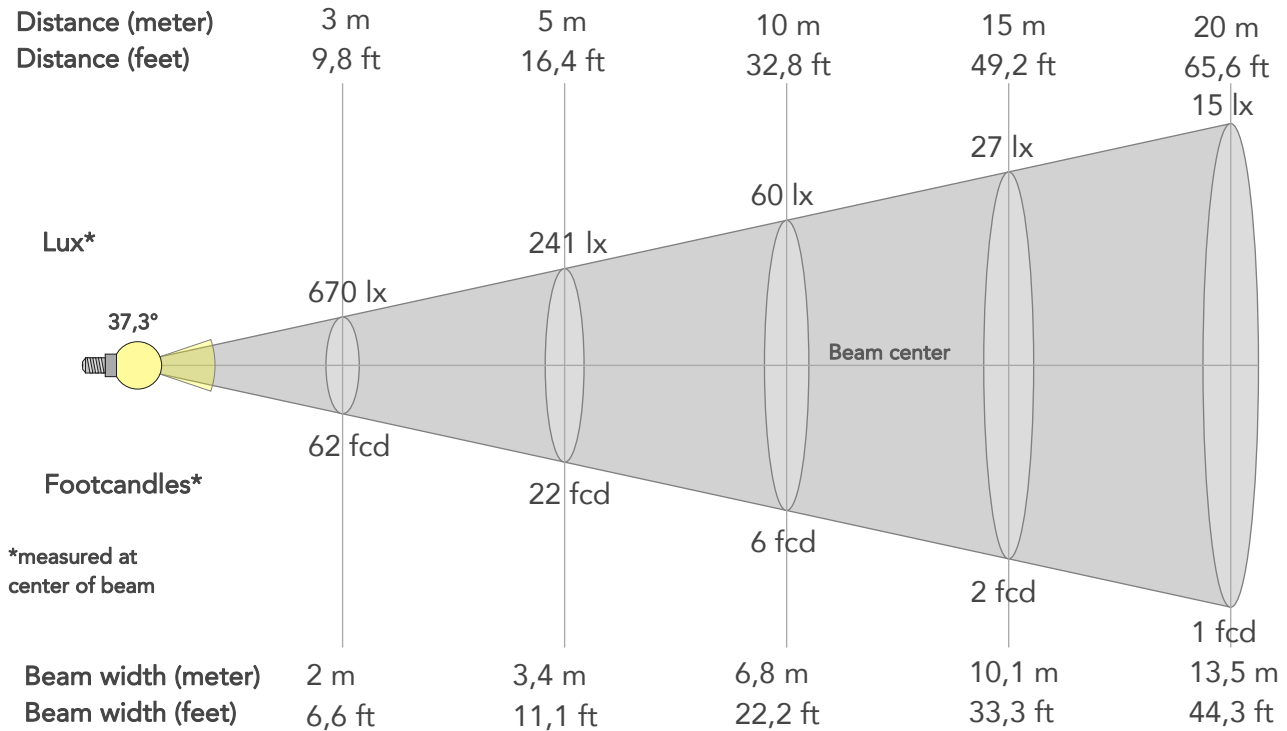

## BEAM INTENSITIES AND WIDTHS

Distance	1m	2m	3m	4m	5m	7,5m	10m	15m	20m	25m	30m	40m	50m
Distance	3,3ft	6,6ft	9,8ft	13,1ft	16,4ft	24,6ft	32,8ft	49,2ft	65,6ft	82ft	98,4ft	131,2ft	164ft
Lux	6028lx	1507lx	670lx	377lx	241lx	107lx	60lx	27lx	15lx	10lx	7lx	4lx	2lx
Footcand.	560fcd	140fcd	62fcd	35fcd	22fcd	10fcd	6fcd	2fcd	1fcd	1fcd	1fcd	0fcd	0fcd
Beam wid.	0,7m	1,4m	2m	2,7m	3,4m	5,1m	6,8m	10,1m	13,5m	16,9m	20,3m	27m	33,8m
Beam wid.	2,2ft	4,5ft	6,6ft	8,9ft	11,1ft	16,6ft	22,2ft	33,3ft	44,3ft	55,4ft	66,5ft	88,7ft	110,8ft

## LINEAR DISTRIBUTION DIAGRAM

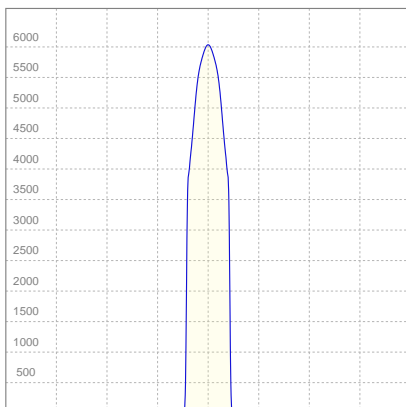

## ELECTRICAL SPECIFICATIONS

Input voltage	Input current	Input power	Effeciency
221V	0,176A	35,2W	48lm/W

Power Fc
0,94

## ISO CANDELA DIAGRAM

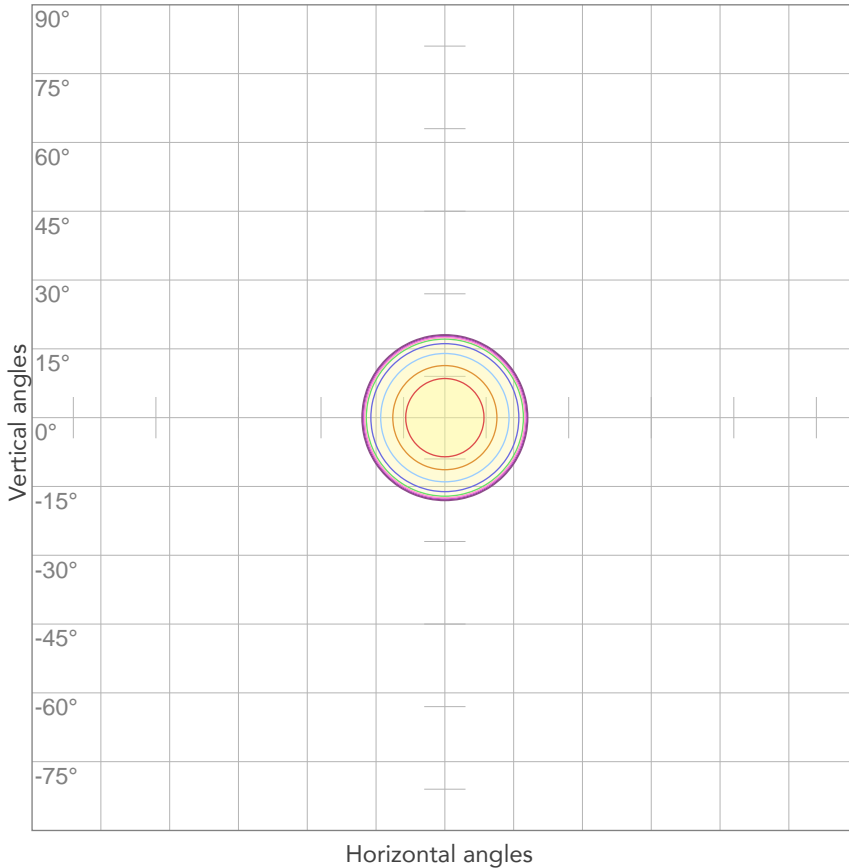

10%	603 cd
20%	1206 cd
30%	1808 cd
40%	2411 cd
50%	3014 cd
60%	3617 cd
70%	4219 cd
80%	4822 cd

Conditions:

Number of c-planes: 2

Candela at center: 6028 cd

## ISO LUX DIAGRAM

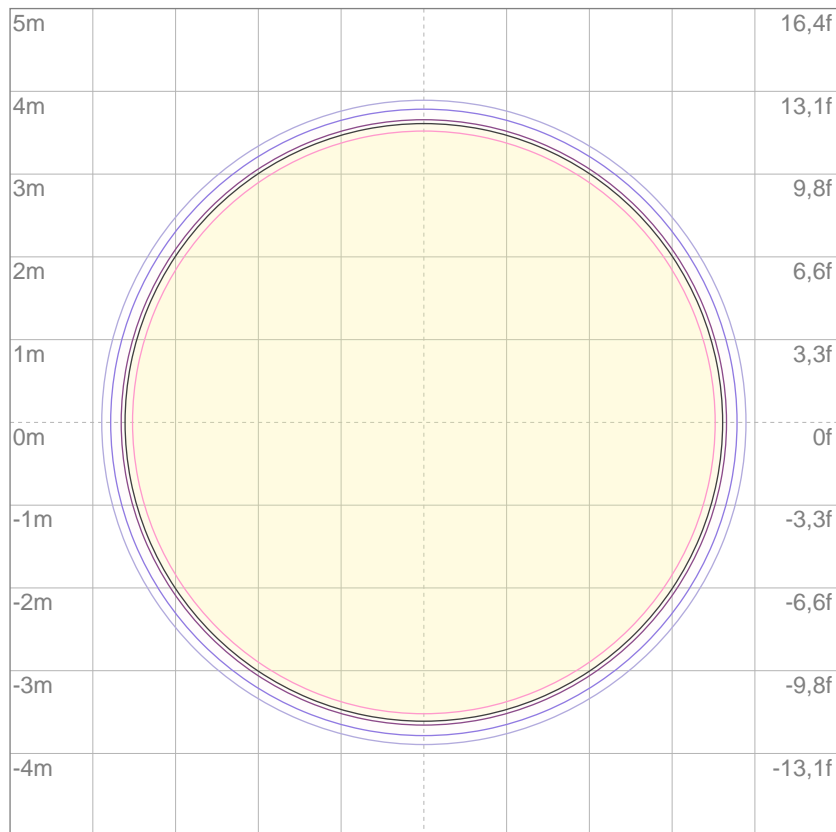

Mounting height: 10 meters (33 feet)

3%	1,81 lx
5%	3,01 lx
10%	6,03 lx
30%	18,1 lx
50%	30,1 lx

Conditions:

Number of c-planes: 2

Lux at center: 60,3 lx

*Lux distribution on a surface when lamp is mounted at 10 meters from the surface.*



Total lumen output:

1556 lm

Peak candela output:

22179 cd

Light quality:

CRI: 90,0

Color temperature:

3009 K

**PRODUCT NAME:**  
ECLDISPLAY

**MEASURAMENT CONDITIONS:**

Beam angle:  
Profile Min Zoom

Target:  
3000K

Operator:  
Paolo Carvone

Date and time:  
22/09/2020 09:35:25

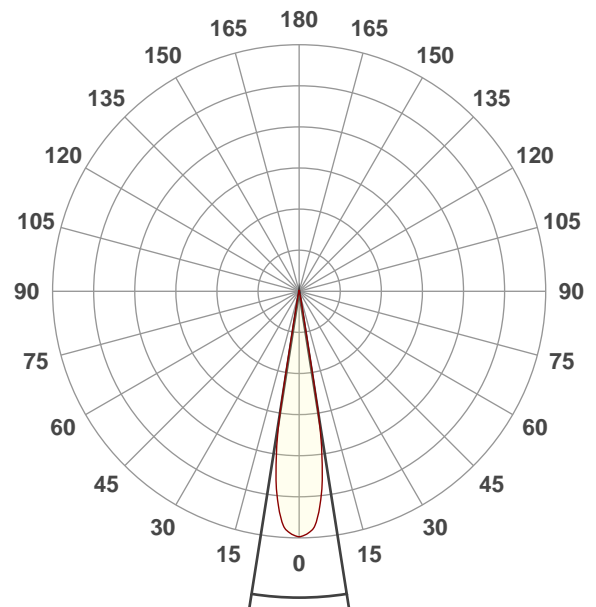

Beam angle 50%: 17,9°  
Field angle 10%: 20,8°  
Cut off angle 2.5%: 23,2°

Spectra

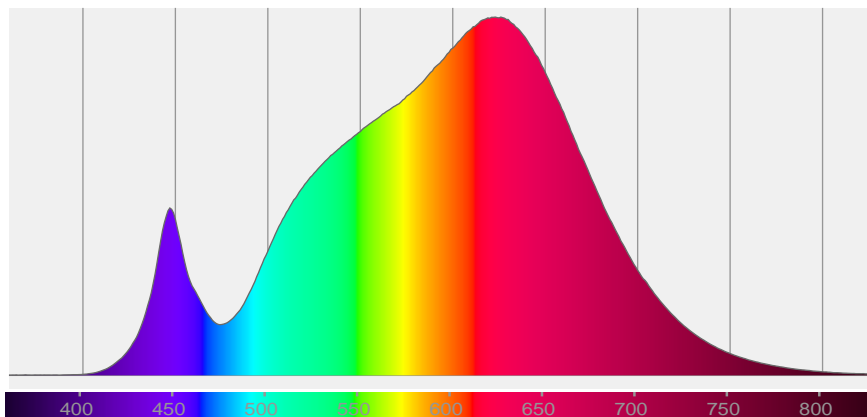

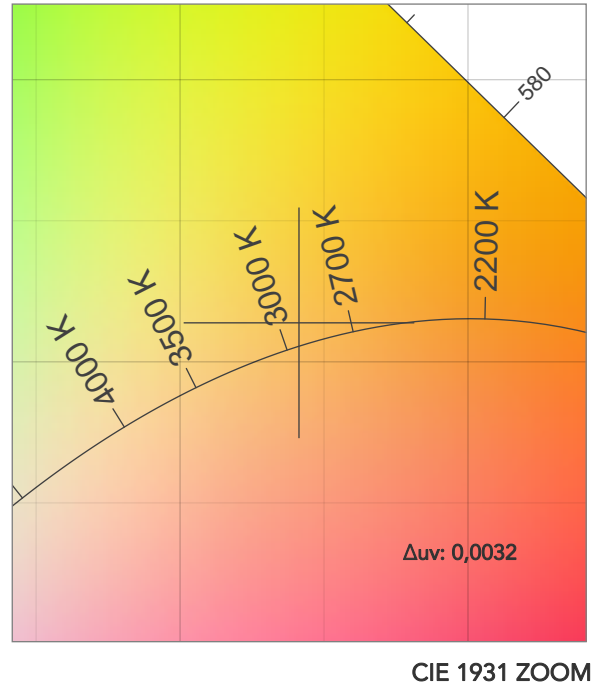
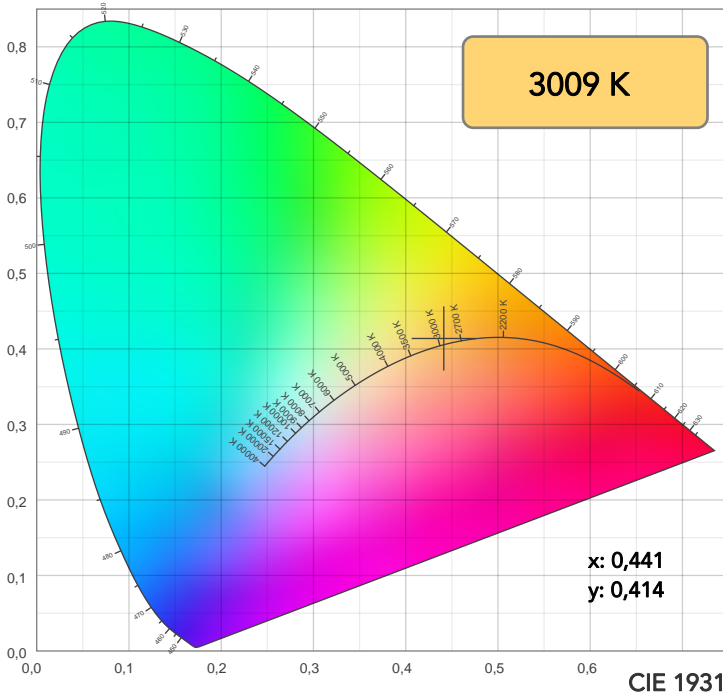

TM30: 89,1

CRI: 90,0 (R1-R8)

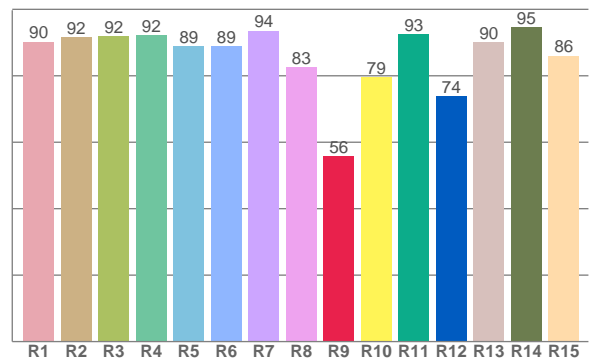
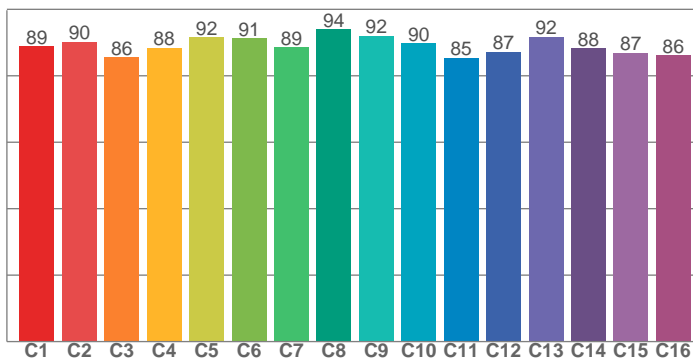

CRI R values, only R1-R8 are used to calculate final CRI value

R1	R2	R3	R4	R5	R6	R7	R8	R9	R10	R11	R12	R13	R14	R15
90,2	91,6	91,8	92,2	89,0	88,9	93,5	82,6	55,8	79,5	92,5	73,9	90,1	94,6	86,0

TM30 C values, 16 binned values out of total of 99 C values

C1	C2	C3	C4	C5	C6	C7	C8	C9	C10	C11	C12	C13	C14	C15	C16
88,8	90,3	85,6	88,4	91,6	91,3	88,5	94,0	92,1	89,7	85,3	87,2	91,8	88,3	87,0	86,1

CQS Q values

Q1	Q2	Q3	Q4	Q5	Q6	Q7	Q8	Q9	Q10	Q11	Q12	Q13	Q14	Q15
86,9	97,1	86,8	87,6	88,5	86,9	89,0	93,3	95,8	91,7	91,0	91,6	92,0	85,0	85,7

CQS: 89,2

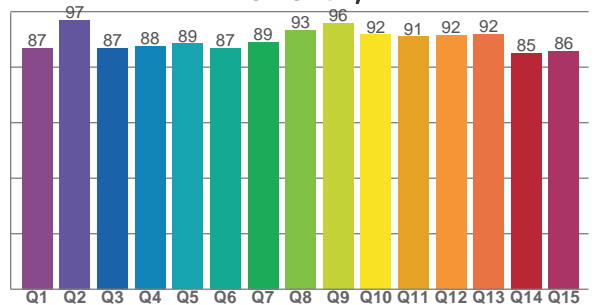

COLOR PARAMETERS

Color temperature	Color rendering index	Red component	Color fidelity	Color gamut	Color quality scale	Television lighting index	Color coordinate cie 1931	Color coordinate cie 1931	Color deviation from black body
CCT	CRI	CRI R9	TM30 Rf	TM30 Rg	CQS	TLCI	x	y	Δuv
3009 K	90,0	55,8	89,1	100,4	89,2	88	0,441	0,414	0,0032

# TM30 DETAILS

**Rf 89,1**  
Fidelity index Rf

**Rg 100,4**  
Gammut index

Hue Bin	R <sub>f</sub>	Graphic shifts (%)	
		Chroma	Hue
1	89	-5%	-2%
2	90	-4%	3%
3	86	-2%	7%
4	88	2%	6%
5	92	3%	5%
6	91	5%	0%
7	89	2%	-6%
8	94	0%	-4%
9	92	-4%	-2%
10	90	-5%	3%
11	85	-2%	9%
12	87	4%	5%
13	92	4%	-1%
14	88	6%	-6%
15	87	1%	-7%
16	86	-1%	-10%

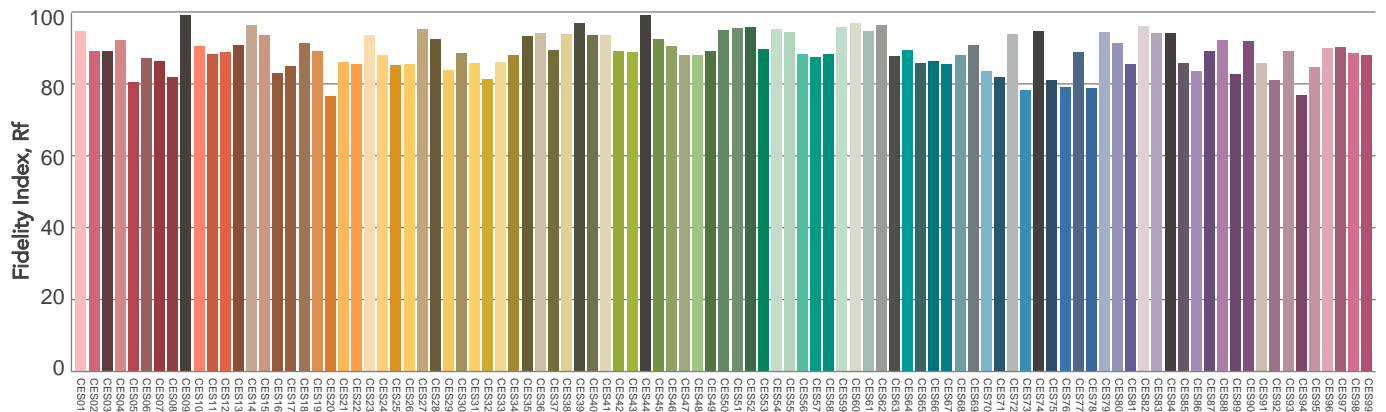
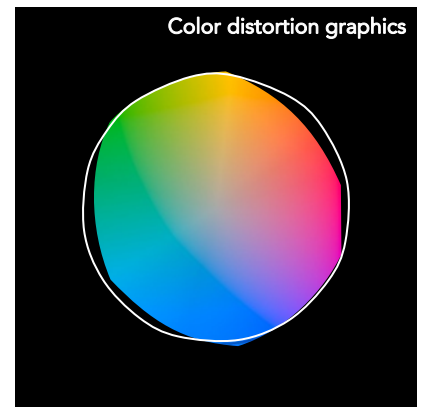
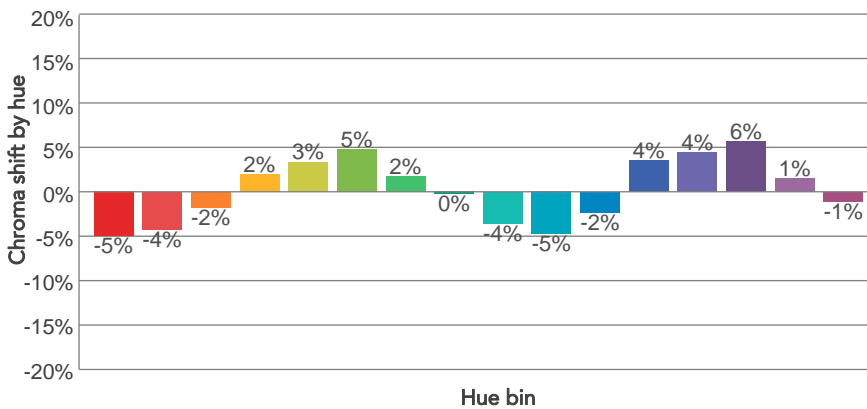
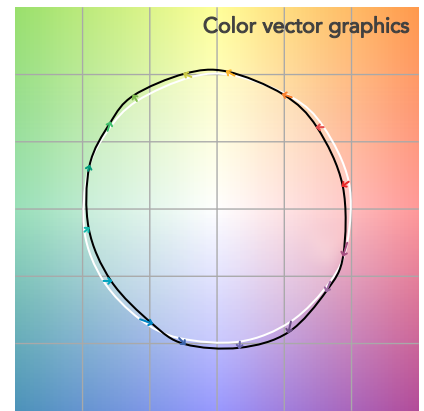
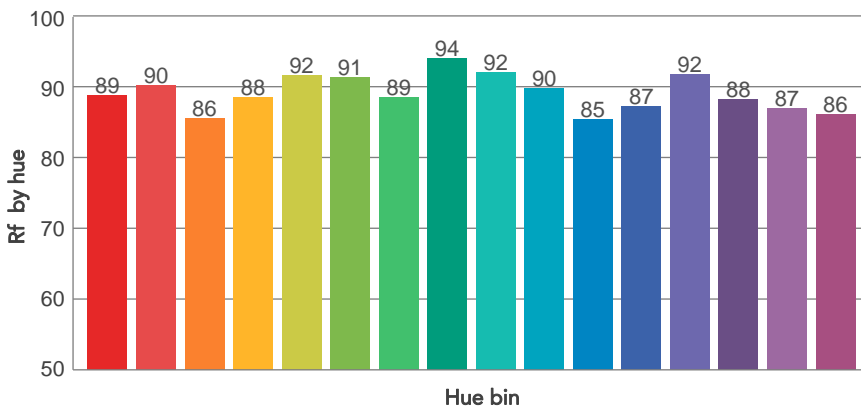
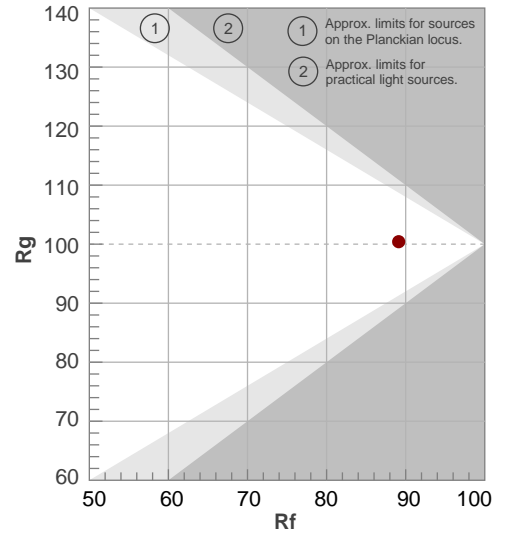

Color Evaluation Sample

# BEAM DETAILS



Beam angle 50%	Field angle 10%	Cut off angle 2,5%	Intensity ratio in 120° cone	Intensity ratio in 90° cone
17,9°	20,8°	23,2°	100,0%	100,0%

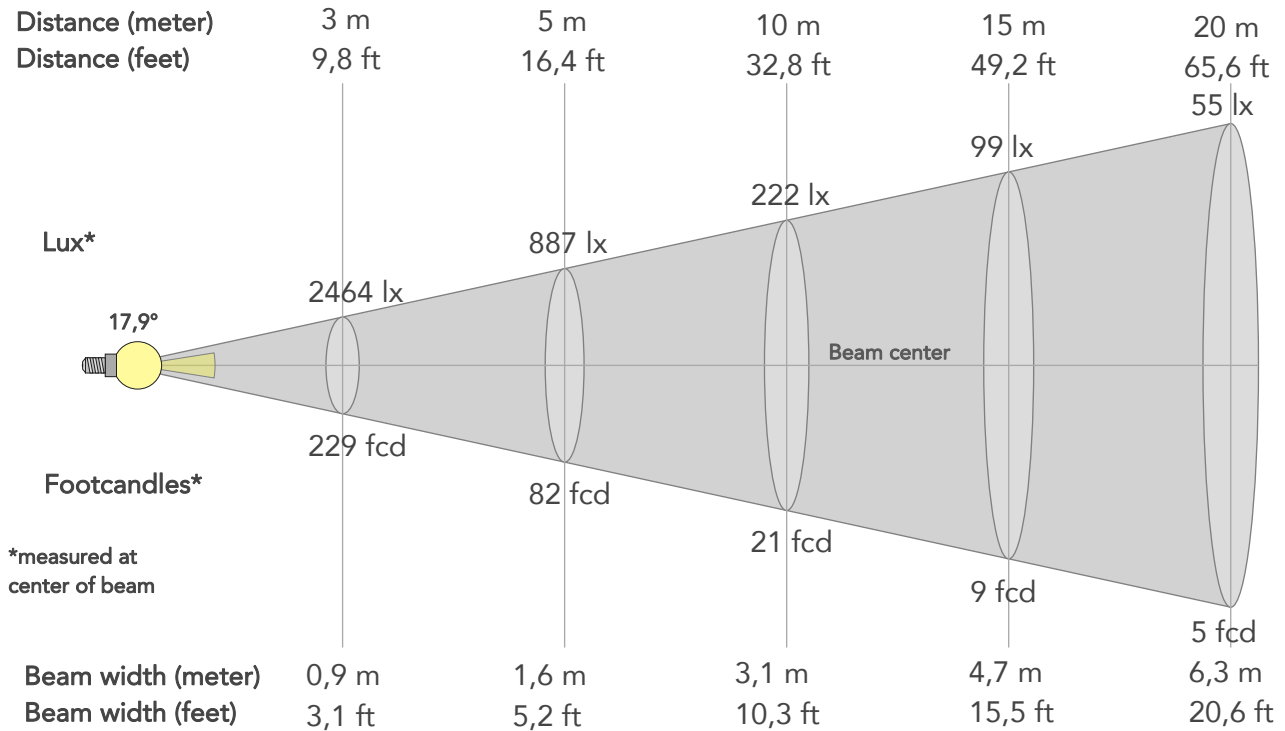

## BEAM INTENSITIES AND WIDTHS

Distance	1m	2m	3m	4m	5m	7,5m	10m	15m	20m	25m	30m	40m	50m
Distance	3,3ft	6,6ft	9,8ft	13,1ft	16,4ft	24,6ft	32,8ft	49,2ft	65,6ft	82ft	98,4ft	131,2ft	164ft
Lux	22179lx	5545lx	2464lx	1386lx	887lx	394lx	222lx	99lx	55lx	35lx	25lx	14lx	9lx
Footcand.	2060fcd	515fcd	229fcd	129fcd	82fcd	37fcd	21fcd	9fcd	5fcd	3fcd	2fcd	1fcd	1fcd
Beam wid.	0,3m	0,6m	0,9m	1,3m	1,6m	2,4m	3,1m	4,7m	6,3m	7,9m	9,4m	12,6m	15,7m
Beam wid.	1ft	2,1ft	3,1ft	4,1ft	5,2ft	7,7ft	10,3ft	15,5ft	20,6ft	25,8ft	31ft	41,3ft	51,6ft

## LINEAR DISTRIBUTION DIAGRAM

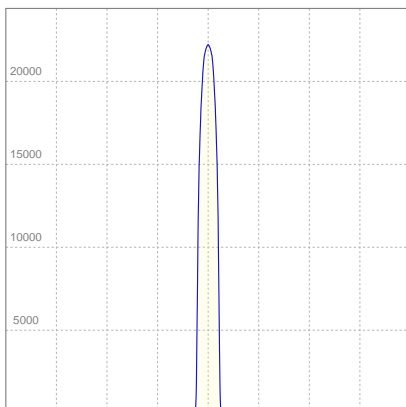

## ELECTRICAL SPECIFICATIONS

Input voltage	Input current	Input power	Effeciency
220V	0,176A	35,0W	44lm/W

Power Fc
0,94

## ISO CANDELA DIAGRAM

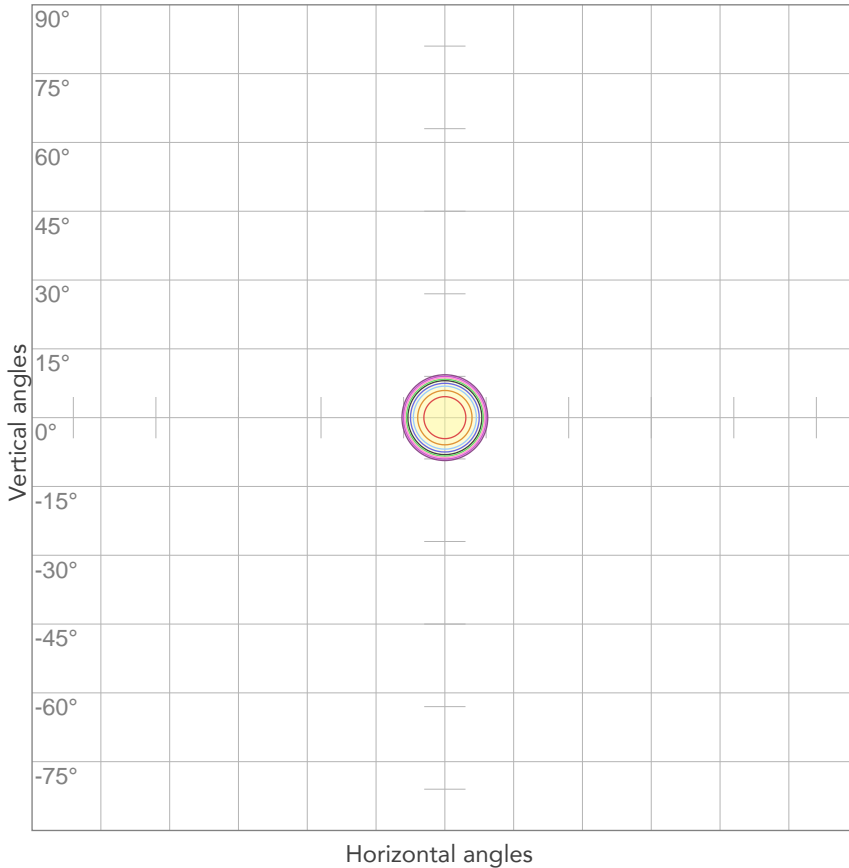

10%	2218 cd
20%	4436 cd
30%	6654 cd
40%	8872 cd
50%	11089 cd
60%	13307 cd
70%	15525 cd
80%	17743 cd

Conditions:

Number of c-planes: 2

Candela at center: 22179 cd

## ISO LUX DIAGRAM

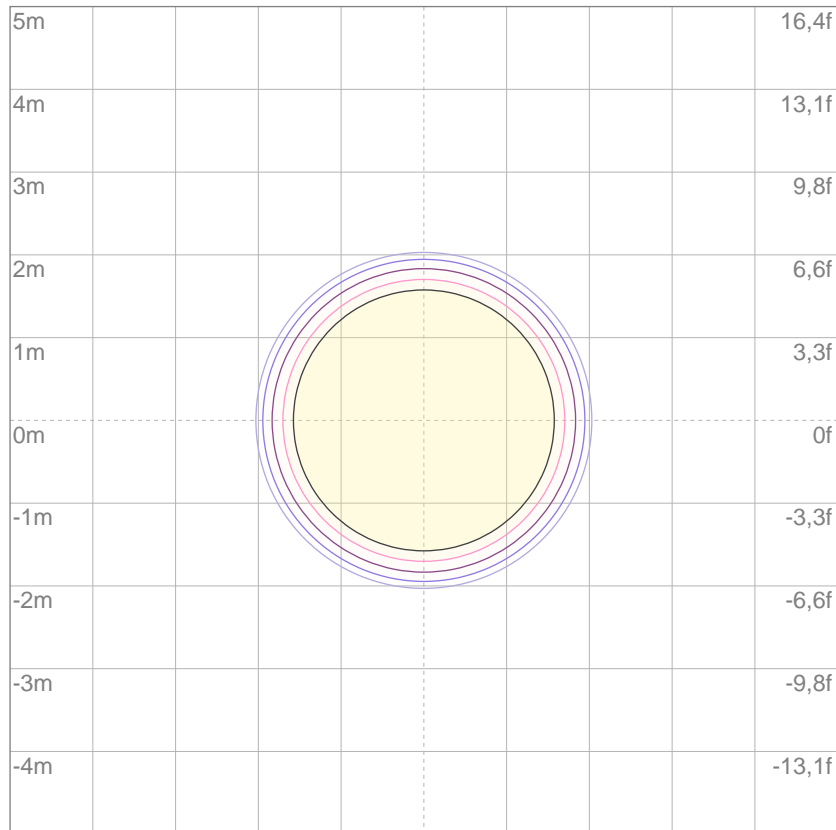

3%	6,65 lx
5%	11,1 lx
10%	22,2 lx
30%	66,5 lx
50%	111 lx

Conditions:

Number of c-planes: 2

Lux at center: 222 lx

*Lux distribution on a surface when lamp is mounted at 10 meters from the surface.*



Total lumen output:

1810 lm

Peak candela output:

6125 cd

Light quality:

CRI: 92,9

Color temperature:

4090 K

**PRODUCT NAME:**

**ECLDISPLAY**

**MEASURAMENT CONDITIONS:**

Beam angle:

Profile Max Zoom

Target:

4000K

Operator:

Paolo Carvone

Date and time:

22/09/2020 09:47:45

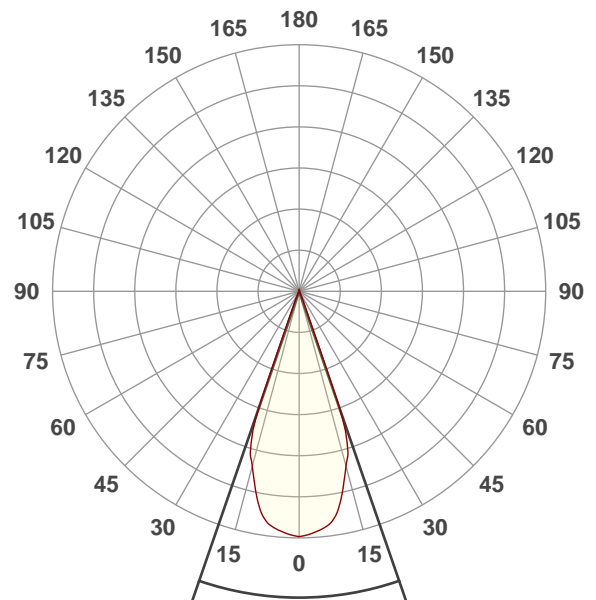

Beam angle 50%: 38,1°

Field angle 10%: 41,6°

Cut off angle 2.5%: 44,4°

Spectra

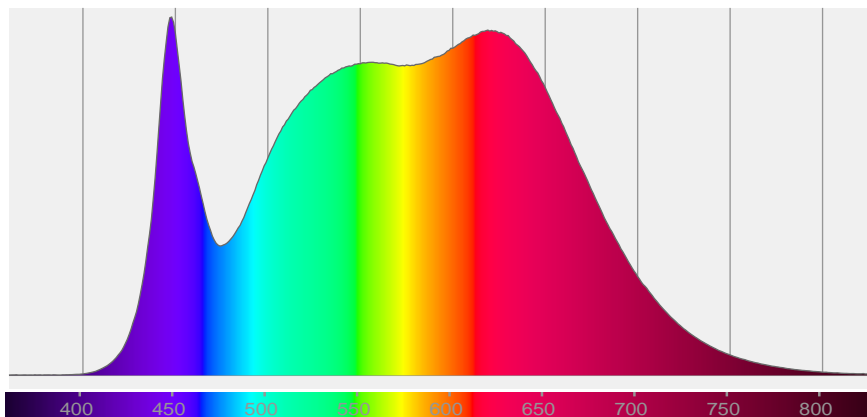



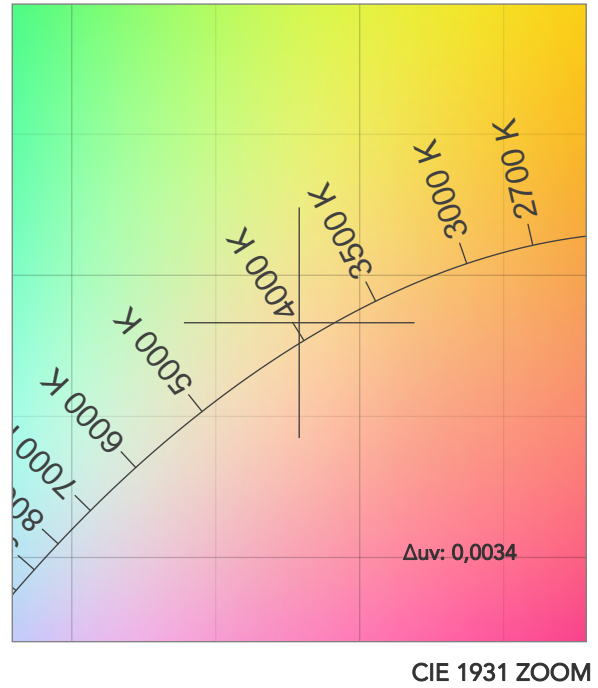
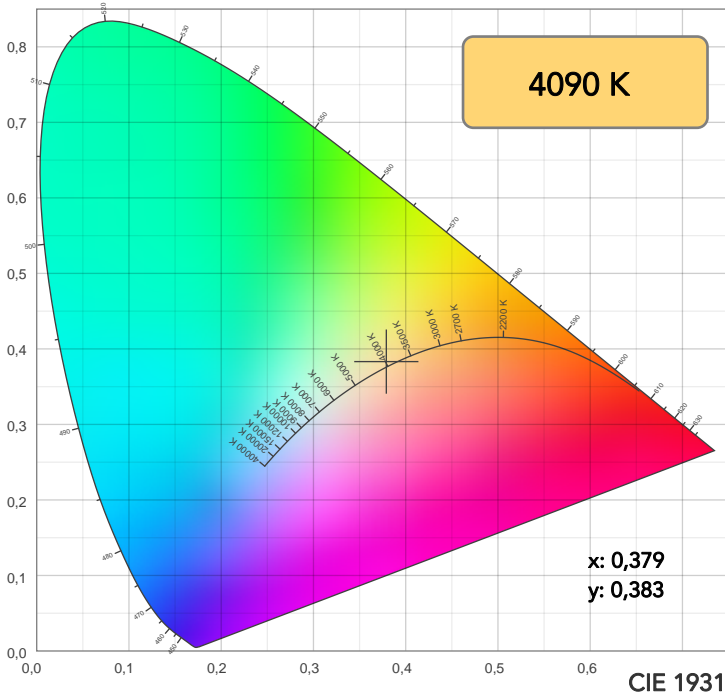

TM30: 91,5

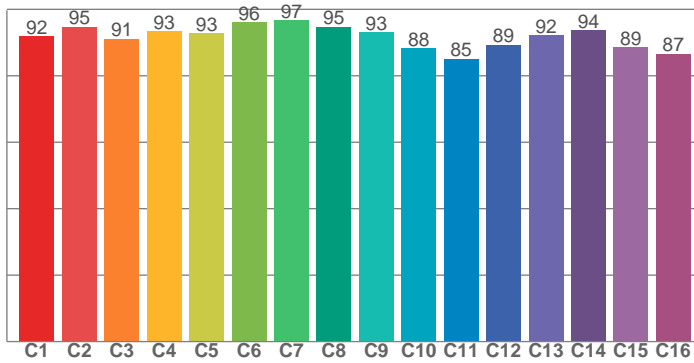

CRI: 92,9 (R1-R8)

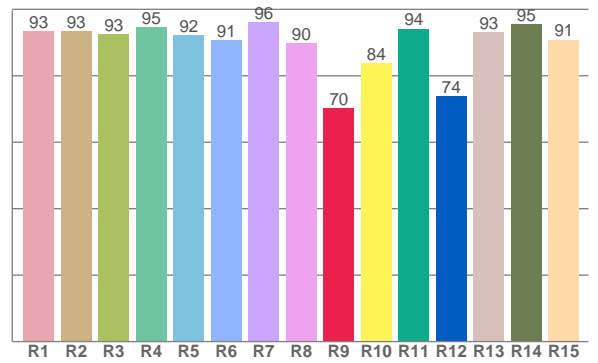

CRI R values, only R1-R8 are used to calculate final CRI value

R1	R2	R3	R4	R5	R6	R7	R8	R9	R10	R11	R12	R13	R14	R15
93,3	93,5	92,6	94,6	92,2	90,7	96,2	89,8	70,2	83,8	94,2	73,9	93,1	95,5	90,8

TM30 C values, 16 binned values out of total of 99 C values

C1	C2	C3	C4	C5	C6	C7	C8	C9	C10	C11	C12	C13	C14	C15	C16
91,9	94,7	91,1	93,4	92,8	96,1	96,7	94,7	93,1	88,2	85,2	89,4	92,2	93,6	88,5	86,7

CQS Q values

Q1	Q2	Q3	Q4	Q5	Q6	Q7	Q8	Q9	Q10	Q11	Q12	Q13	Q14	Q15
93,7	99,1	88,2	89,2	92,9	93,2	93,9	96,8	97,4	94,6	95,0	95,8	96,2	91,6	92,4

CQS: 93,3

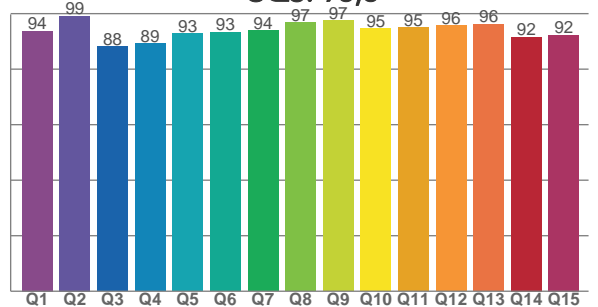

COLOR PARAMETERS

Color temperature	Color rendering index	Red component	Color fidelity	Color gamut	Color quality scale	Television lighting index	Color coordinate cie 1931	Color coordinate cie 1931	Color deviation from black body
CCT	CRI	CRI R9	TM30 Rf	TM30 Rg	CQS	TLCI	x	y	Δuv
4090 K	92,9	70,2	91,5	99,8	93,3	94	0,379	0,383	0,0034

# TM30 DETAILS

**Rf 91,5**  
Fidelity index Rf

**Rg 99,8**  
Gammut index

Hue Bin	R <sub>f</sub>	Graphic shifts (%)	
		Chroma	Hue
1	92	-4%	-1%
2	95	-2%	1%
3	91	-2%	4%
4	93	-1%	3%
5	93	-1%	2%
6	96	2%	0%
7	97	-1%	-1%
8	95	-2%	0%
9	93	-3%	3%
10	88	-3%	6%
11	85	2%	9%
12	89	3%	4%
13	92	5%	-2%
14	94	3%	-1%
15	89	2%	-7%
16	87	1%	-8%

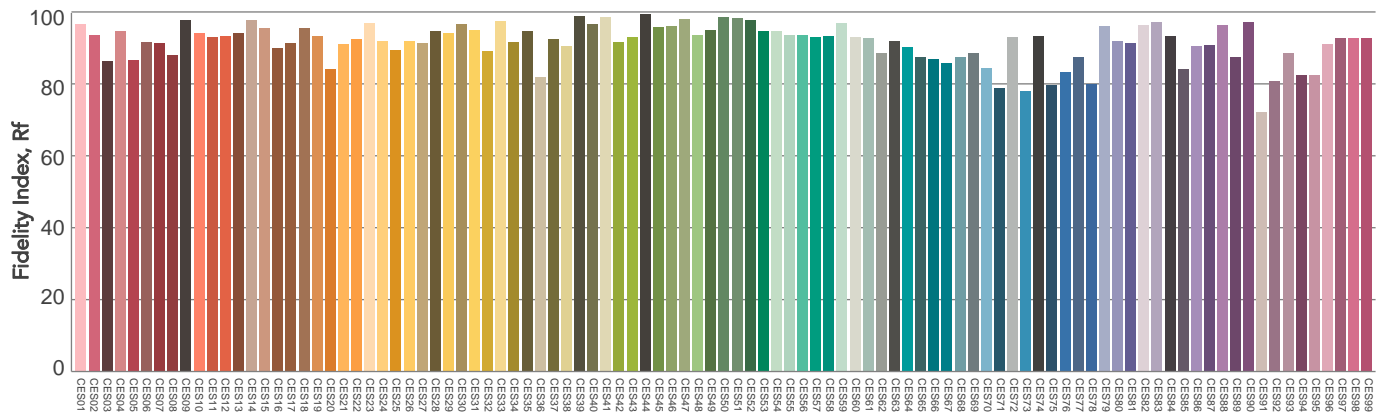
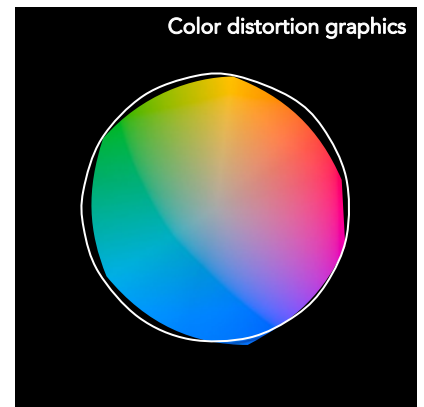
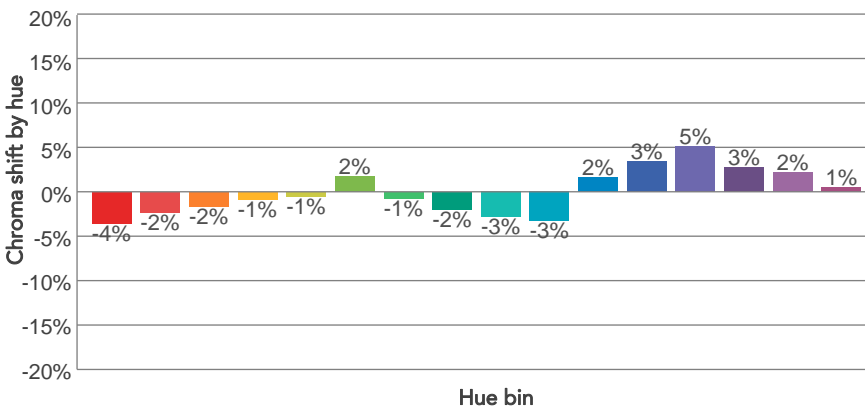
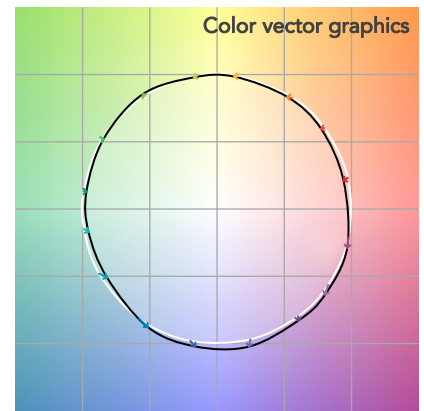
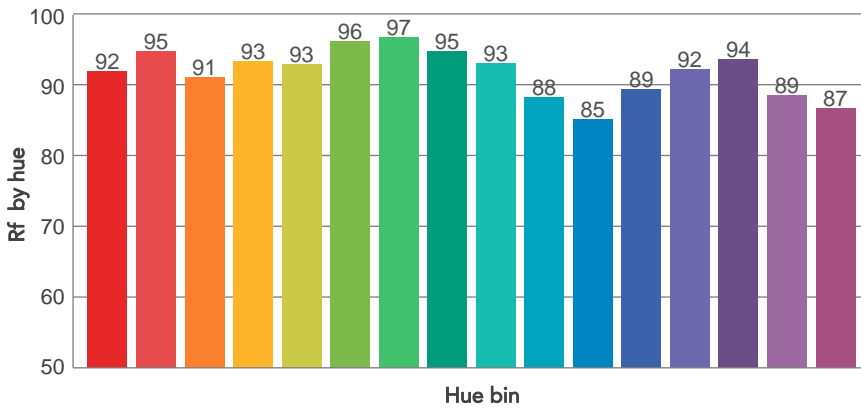
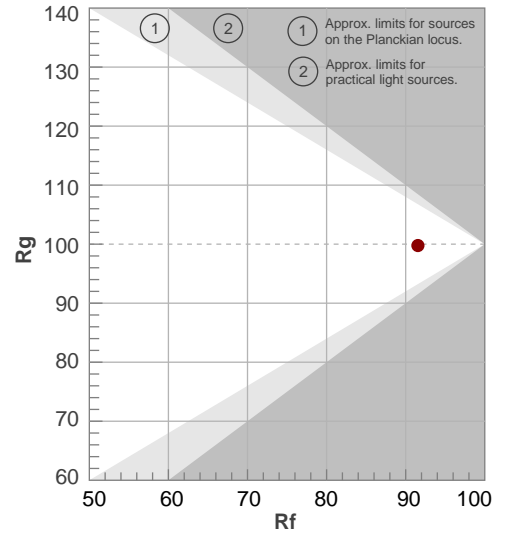

# BEAM DETAILS



Beam angle 50%	Field angle 10%	Cut off angle 2,5%	Intensity ratio in 120° cone	Intensity ratio in 90° cone
38,1°	41,6°	44,4°	100,0%	100,0%

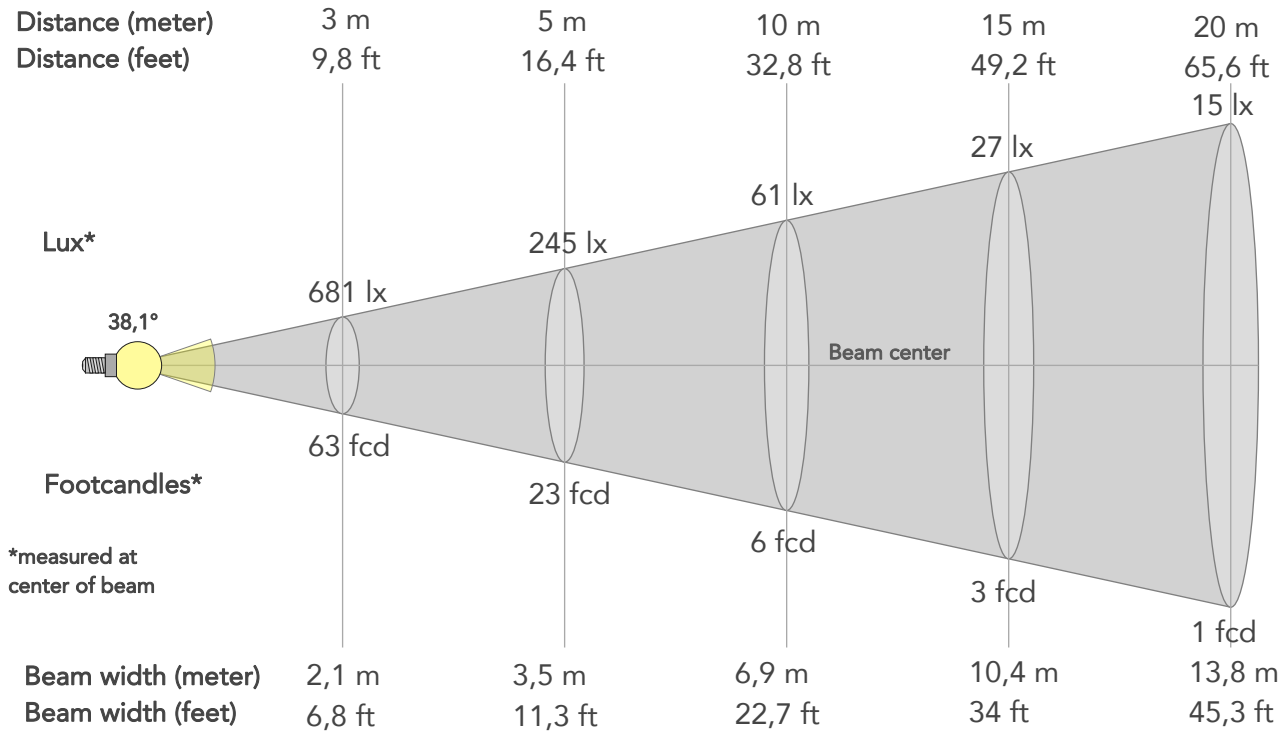

## BEAM INTENSITIES AND WIDTHS

Distance	1m	2m	3m	4m	5m	7,5m	10m	15m	20m	25m	30m	40m	50m
Distance	3,3ft	6,6ft	9,8ft	13,1ft	16,4ft	24,6ft	32,8ft	49,2ft	65,6ft	82ft	98,4ft	131,2ft	164ft
Lux	6125lx	1531lx	681lx	383lx	245lx	109lx	61lx	27lx	15lx	10lx	7lx	4lx	2lx
Footcand.	569fcd	142fcd	63fcd	36fcd	23fcd	10fcd	6fcd	3fcd	1fcd	1fcd	1fcd	0fcd	0fcd
Beam wid.	0,7m	1,4m	2,1m	2,8m	3,5m	5,2m	6,9m	10,4m	13,8m	17,3m	20,7m	27,6m	34,5m
Beam wid.	2,3ft	4,6ft	6,8ft	9ft	11,3ft	17ft	22,7ft	34ft	45,3ft	56,6ft	68ft	90,6ft	113,3ft

## LINEAR DISTRIBUTION DIAGRAM

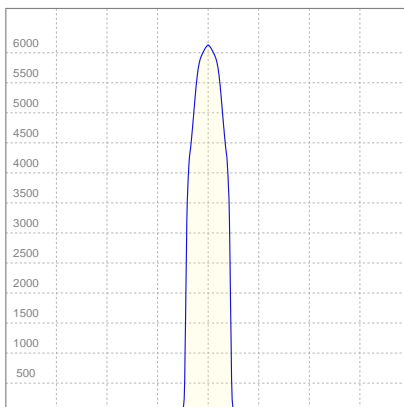

## ELECTRICAL SPECIFICATIONS

Input voltage	Input current	Input power	Effeciency
222V	0,175A	35,2W	51lm/W
<b>Power Fc</b>			
0,94			

## ISO CANDELA DIAGRAM

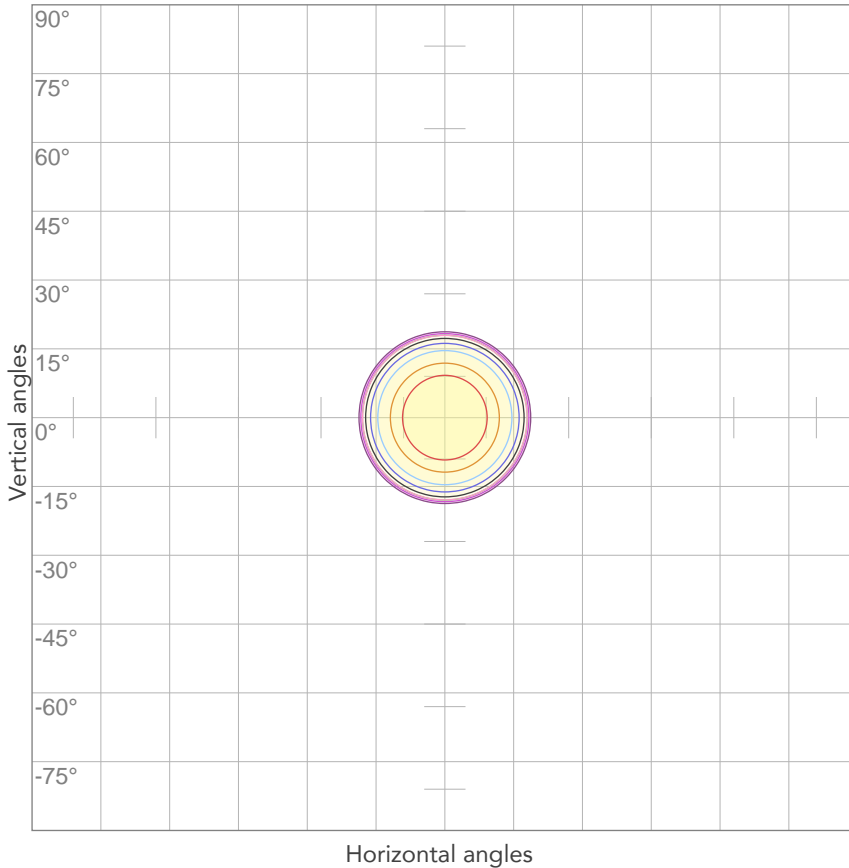

10%	612 cd
20%	1225 cd
30%	1837 cd
40%	2450 cd
50%	3062 cd
60%	3675 cd
70%	4287 cd
80%	4900 cd

Conditions:

Number of c-planes: 2

Candela at center: 6125 cd

## ISO LUX DIAGRAM

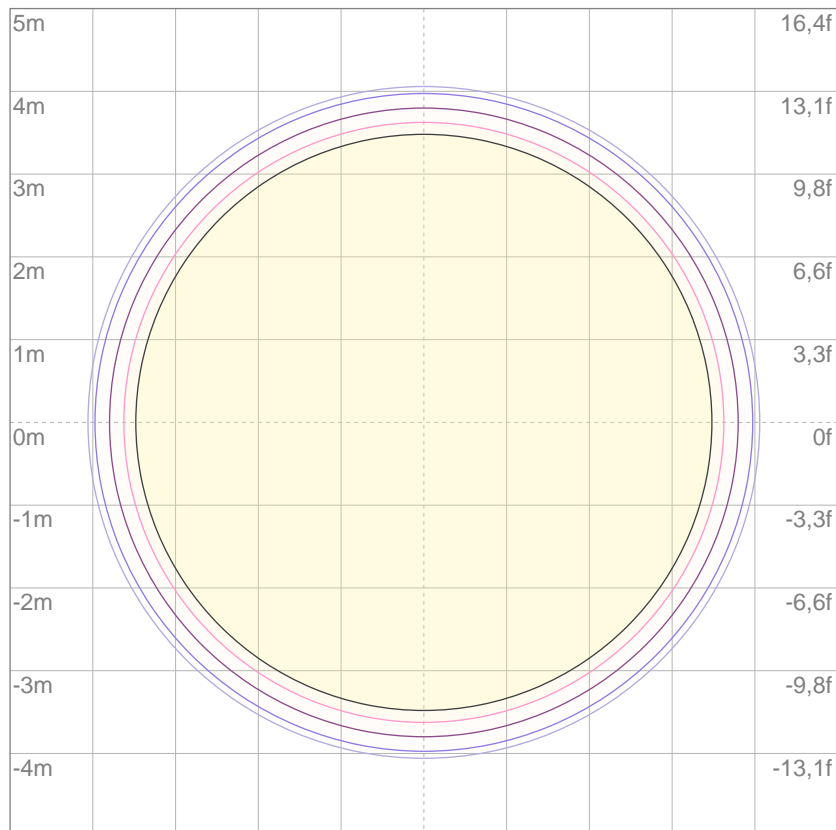

3%	1,84 lx
5%	3,06 lx
10%	6,12 lx
30%	18,4 lx
50%	30,6 lx

Conditions:

Number of c-planes: 2

Lux at center: 61,2 lx

*Lux distribution on a surface when lamp is mounted at 10 meters from the surface.*

Mounting height: 10 meters (33 feet)



Total lumen output:

1576 lm

Peak candela output:

23084 cd

Light quality:

CRI: 92,9

Color temperature:

4019 K

PRODUCT NAME:  
ECLDISPLAY

MEASURAMENT CONDITIONS:

Beam angle:  
Profile Min Zoom

Target:  
4000K

Operator:  
Paolo Carvone

Date and time:  
22/09/2020 09:49:54

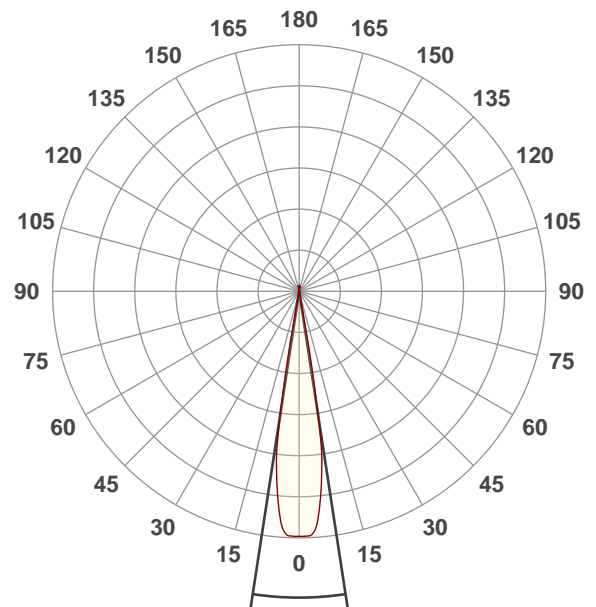

Beam angle 50%: 17,4°  
Field angle 10%: 20,8°  
Cut off angle 2.5%: 21,5°

Spectra

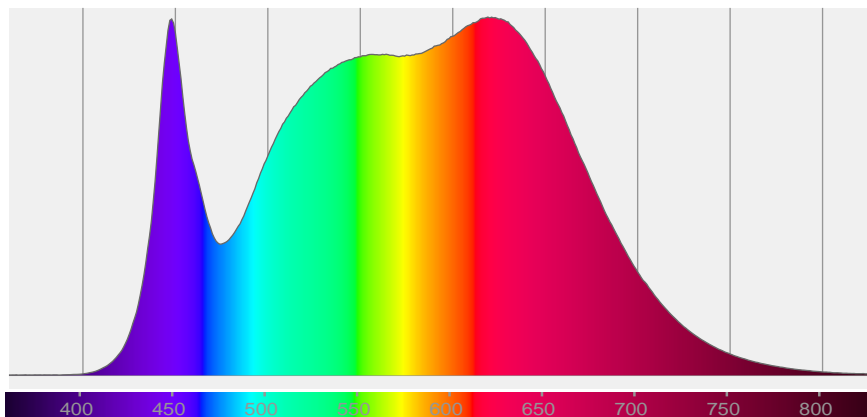

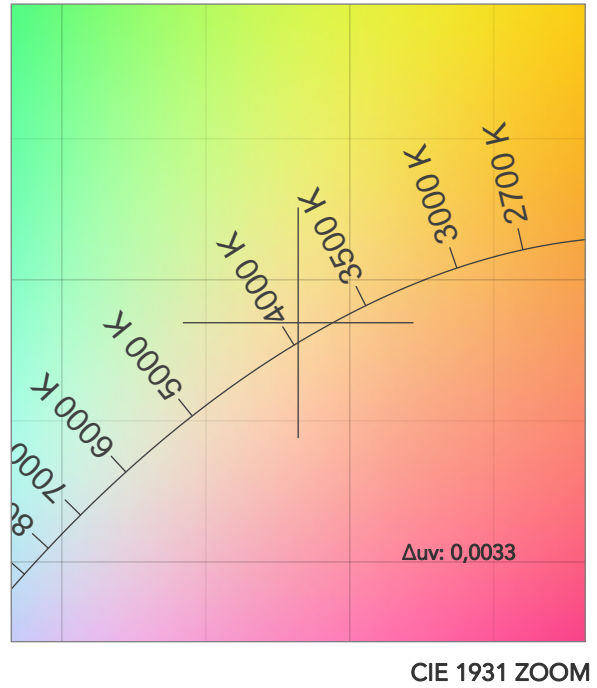
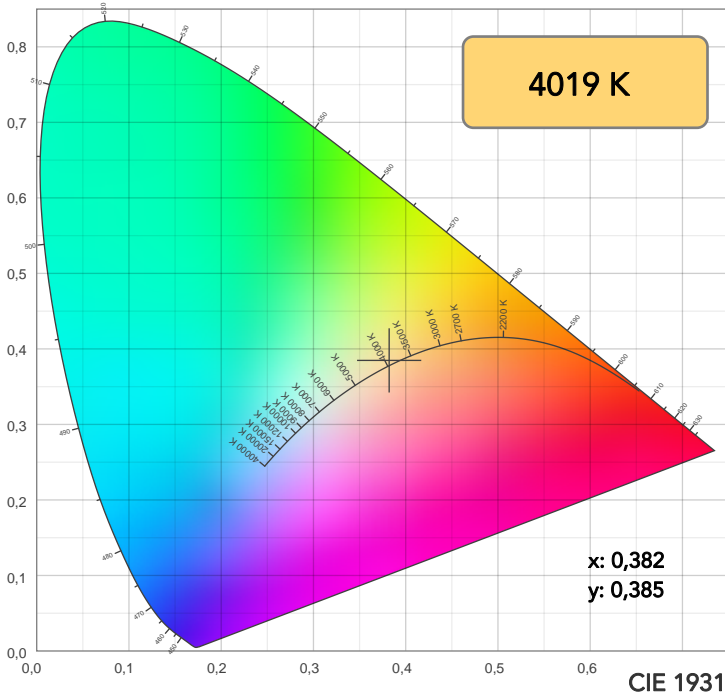

TM30: 91,6

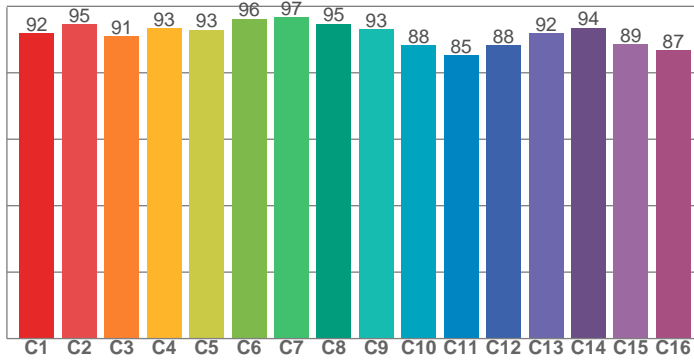

CRI: 92,9 (R1-R8)

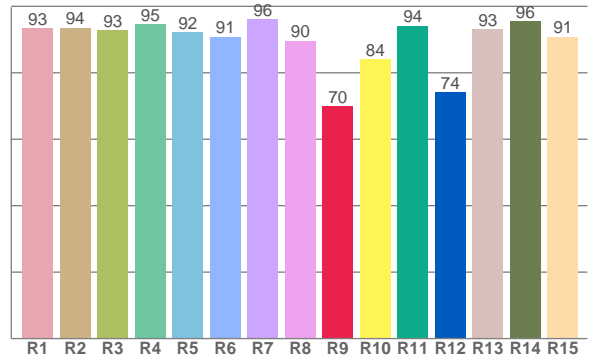

CRI R values, only R1-R8 are used to calculate final CRI value

R1	R2	R3	R4	R5	R6	R7	R8	R9	R10	R11	R12	R13	R14	R15
93,3	93,6	92,7	94,6	92,3	90,9	96,2	89,6	70,0	84,0	94,2	74,2	93,1	95,5	90,8

TM30 C values, 16 binned values out of total of 99 C values

C1	C2	C3	C4	C5	C6	C7	C8	C9	C10	C11	C12	C13	C14	C15	C16
91,8	94,6	91,0	93,3	92,9	96,1	96,7	94,8	93,1	88,2	85,3	88,2	91,9	93,6	88,5	86,8

CQS Q values

Q1	Q2	Q3	Q4	Q5	Q6	Q7	Q8	Q9	Q10	Q11	Q12	Q13	Q14	Q15
93,6	99,1	88,2	89,2	92,8	93,2	93,9	96,7	97,5	94,6	95,0	95,7	96,1	91,5	92,3

CQS: 93,3

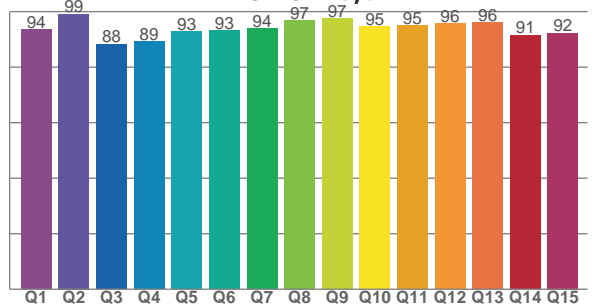

COLOR PARAMETERS

Color temperature	Color rendering index	Red component	Color fidelity	Color gamut	Color quality scale	Television lighting index	Color coordinate cie 1931	Color coordinate cie 1931	Color deviation from black body
CCT	CRI	CRI R9	TM30 Rf	TM30 Rg	CQS	TLCI	x	y	Δuv
4019 K	92,9	70,0	91,6	99,8	93,3	94	0,382	0,385	0,0033

# TM30 DETAILS

**Rf 91,6**  
Fidelity index Rf

**Rg 99,8**  
Gammut index

Hue Bin	R <sub>f</sub>	Graphic shifts (%)	
		Chroma	Hue
1	92	-4%	-1%
2	95	-2%	1%
3	91	-2%	4%
4	93	-1%	3%
5	93	-1%	2%
6	96	2%	0%
7	97	-1%	-1%
8	95	-2%	0%
9	93	-3%	3%
10	88	-3%	6%
11	85	2%	9%
12	88	3%	5%
13	92	4%	-2%
14	94	4%	-2%
15	89	2%	-7%
16	87	0%	-8%

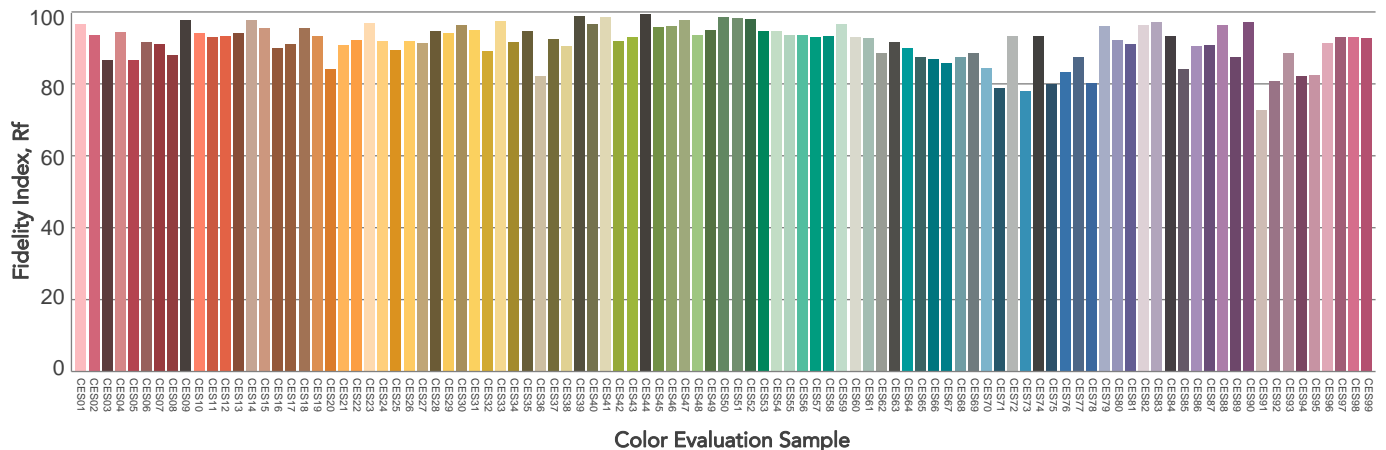
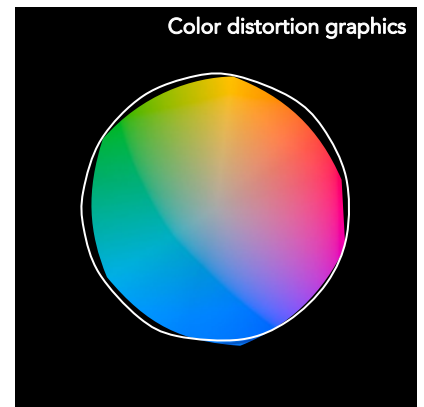
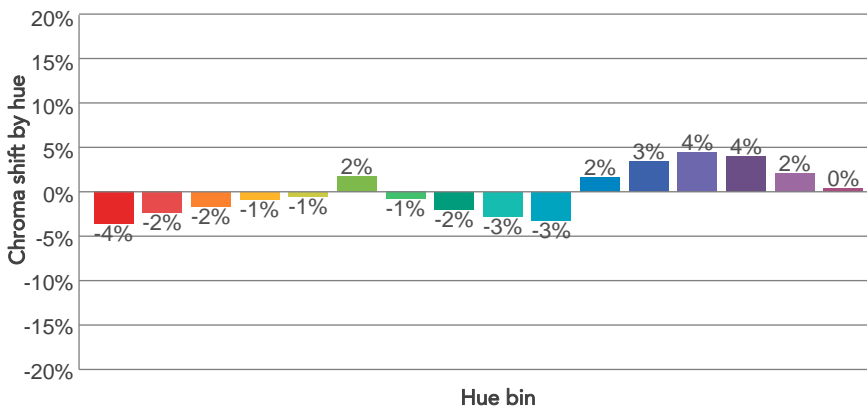
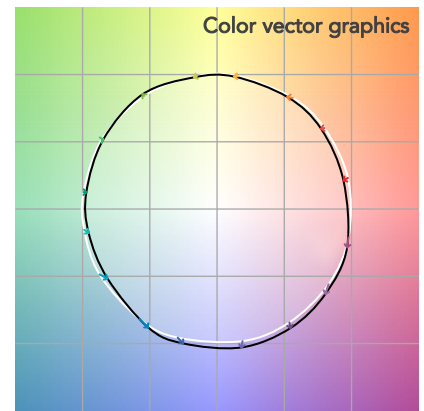
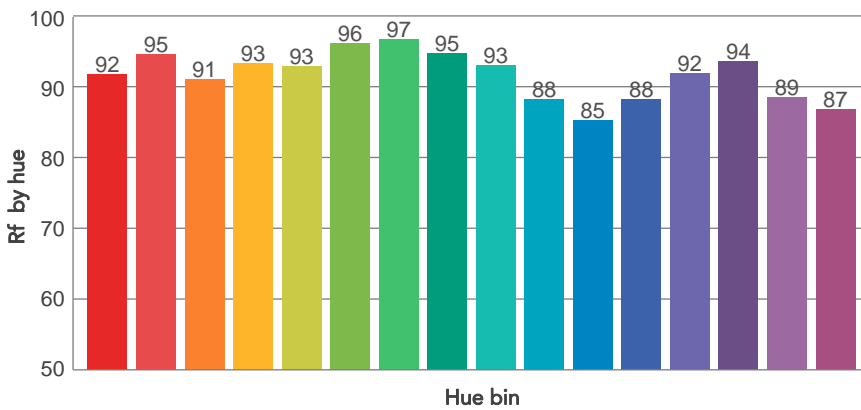
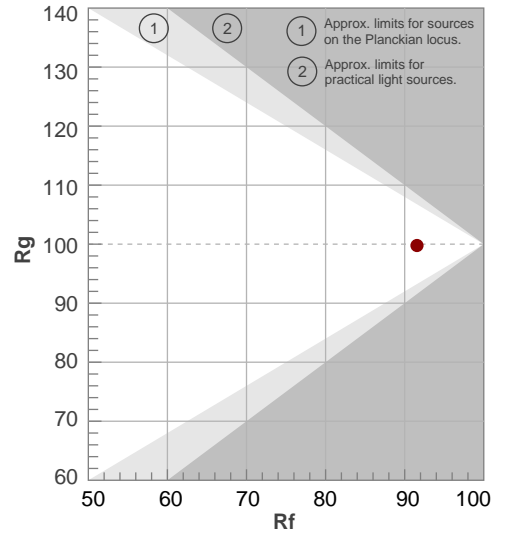

# BEAM DETAILS



Beam angle 50%	Field angle 10%	Cut off angle 2,5%	Intensity ratio in 120° cone	Intensity ratio in 90° cone
17,4°	20,8°	21,5°	100,0%	100,0%

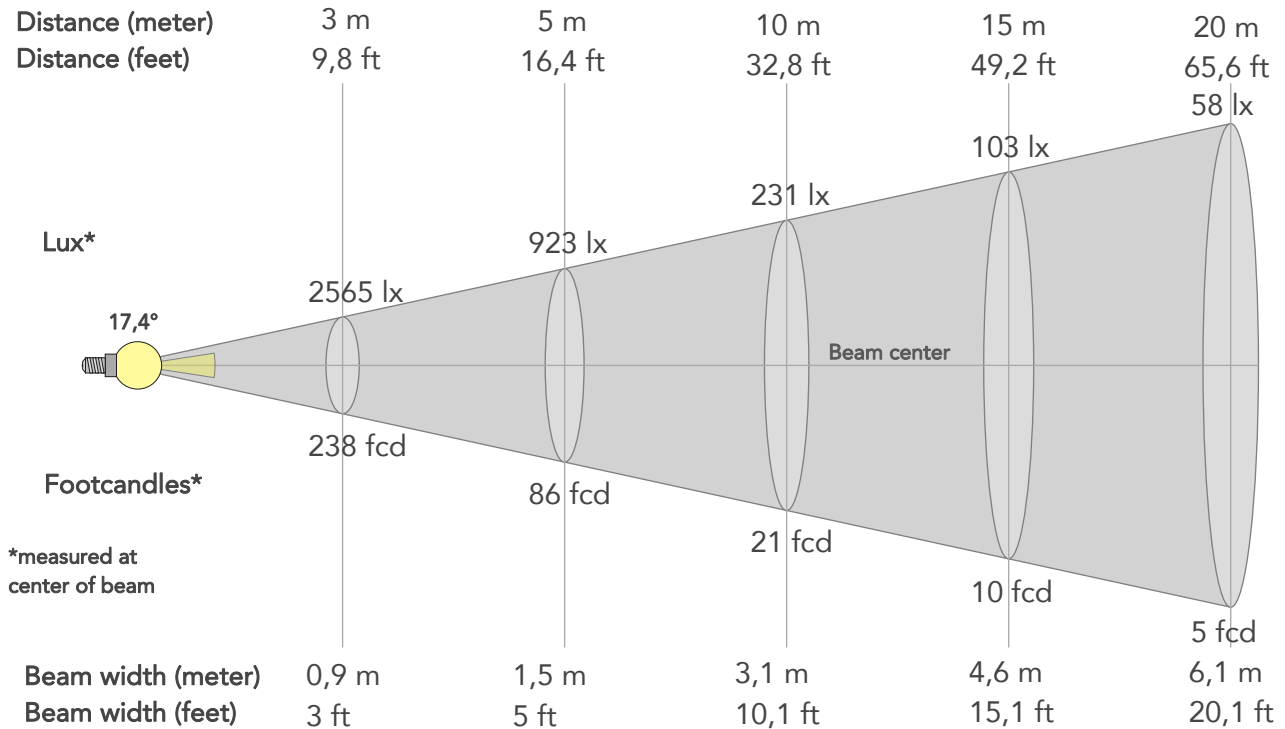

## BEAM INTENSITIES AND WIDTHS

Distance	1m	2m	3m	4m	5m	7,5m	10m	15m	20m	25m	30m	40m	50m
Distance	3,3ft	6,6ft	9,8ft	13,1ft	16,4ft	24,6ft	32,8ft	49,2ft	65,6ft	82ft	98,4ft	131,2ft	164ft
Lux	23084lx	5771lx	2565lx	1443lx	923lx	410lx	231lx	103lx	58lx	37lx	26lx	14lx	9lx
Footcand.	2145fcd	536fcd	238fcd	134fcd	86fcd	38fcd	21fcd	10fcd	5fcd	3fcd	2fcd	1fcd	1fcd
Beam wid.	0,3m	0,6m	0,9m	1,2m	1,5m	2,3m	3,1m	4,6m	6,1m	7,7m	9,2m	12,3m	15,3m
Beam wid.	1ft	2ft	3ft	4ft	5ft	7,5ft	10,1ft	15,1ft	20,1ft	25,1ft	30,2ft	40,2ft	50,3ft

## LINEAR DISTRIBUTION DIAGRAM

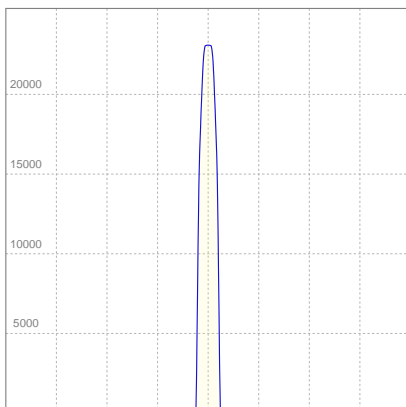

## ELECTRICAL SPECIFICATIONS

Input voltage	Input current	Input power	Effeciency
222V	0,175A	35,1W	45lm/W

Power Fc
0,94



## ISO CANDELA DIAGRAM

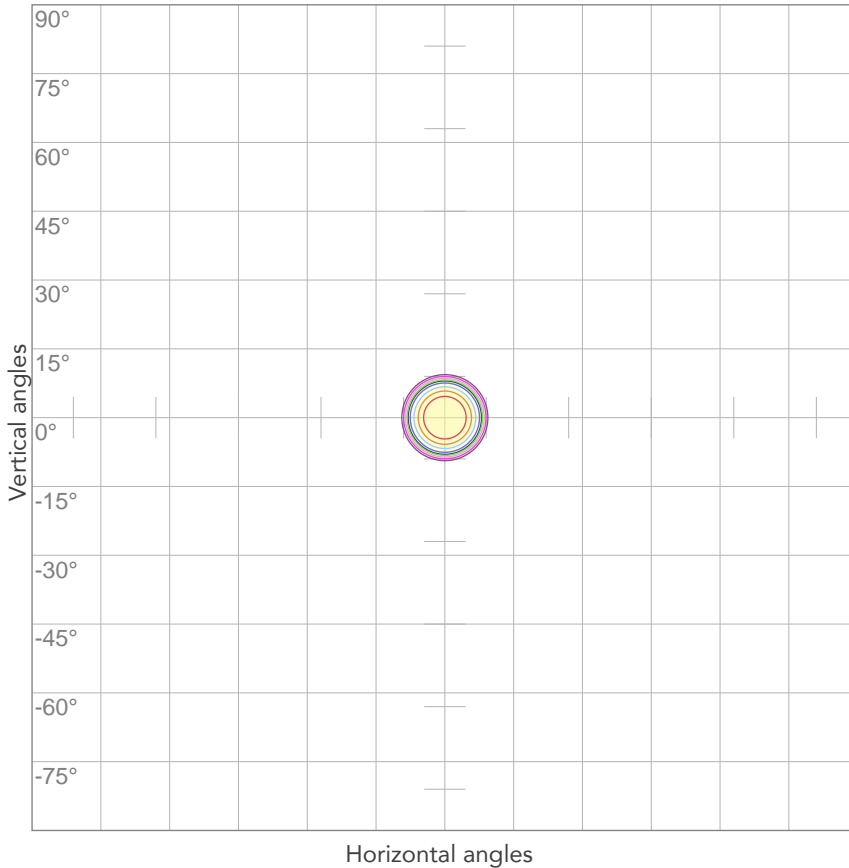

10%	2308 cd
20%	4617 cd
30%	6925 cd
40%	9234 cd
50%	11542 cd
60%	13851 cd
70%	16159 cd
80%	18468 cd

Conditions:

Number of c-planes: 2

Candela at center: 23084 cd

## ISO LUX DIAGRAM

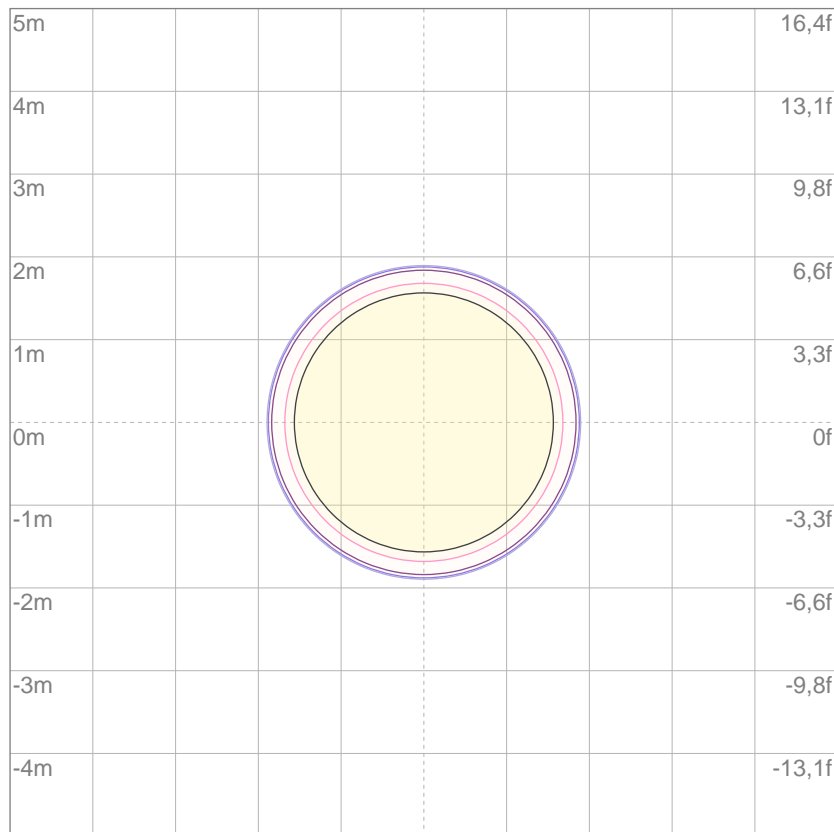

3%	6,93 lx
5%	11,5 lx
10%	23,1 lx
30%	69,3 lx
50%	115 lx

Conditions:

Number of c-planes: 2

Lux at center: 231 lx

*Lux distribution on a surface when lamp is mounted at 10 meters from the surface.*

Mounting height: 10 meters (33 feet)



Total lumen output:

1869 lm

Peak candela output:

6408 cd

Light quality:

CRI: 90,5

Color temperature:

5817 K

**PRODUCT NAME:**

ECLDISPLAY

**MEASURAMENT CONDITIONS:**

Beam angle:

Profile Max Zoom

Target:

5600K

Operator:

Paolo Carvone

Date and time:

22/09/2020 10:00:01

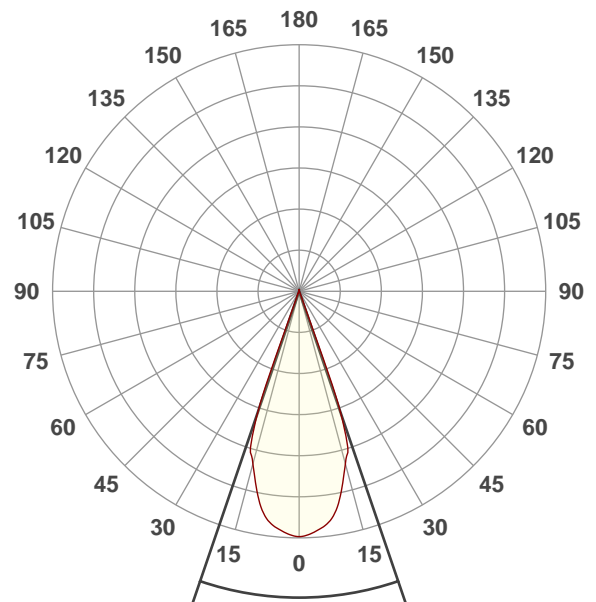

Beam angle 50%: 37,7°

Field angle 10%: 41,7°

Cut off angle 2.5%: 43,2°

Spectra

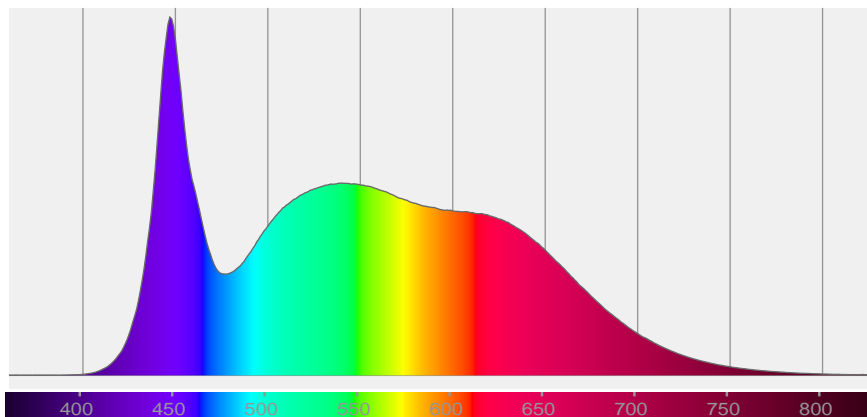

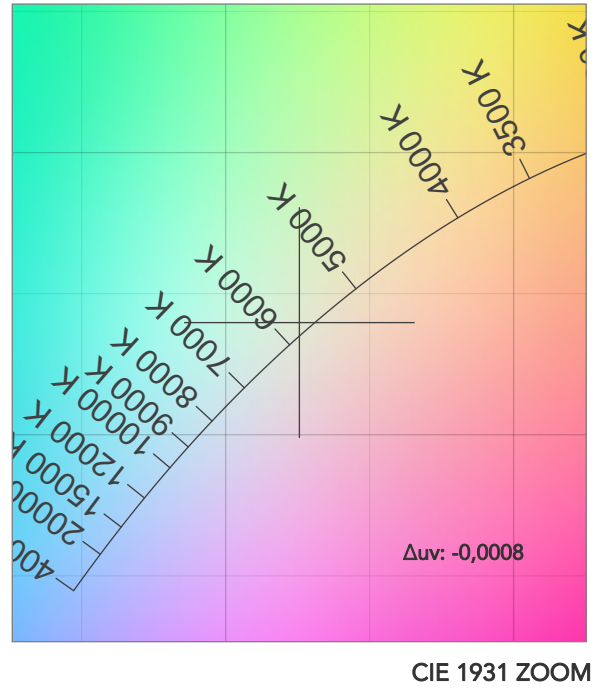
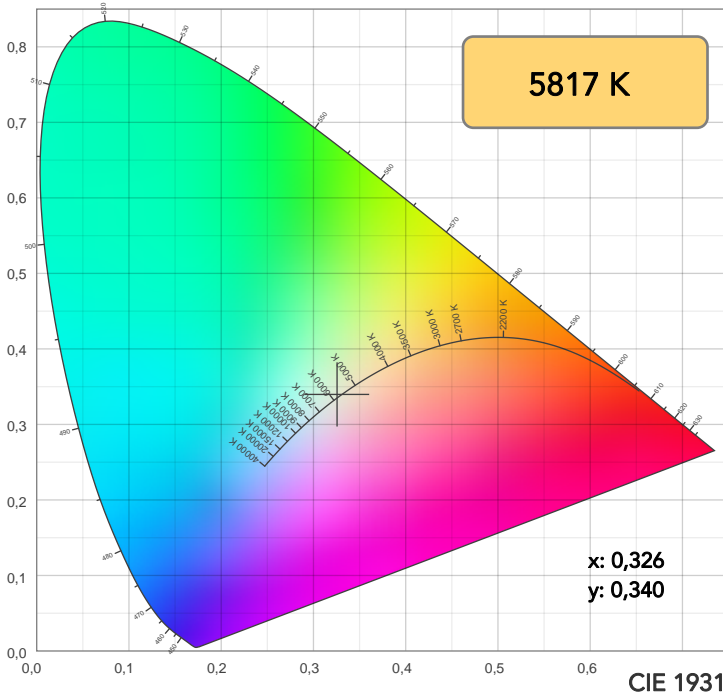

TM30: 88,4

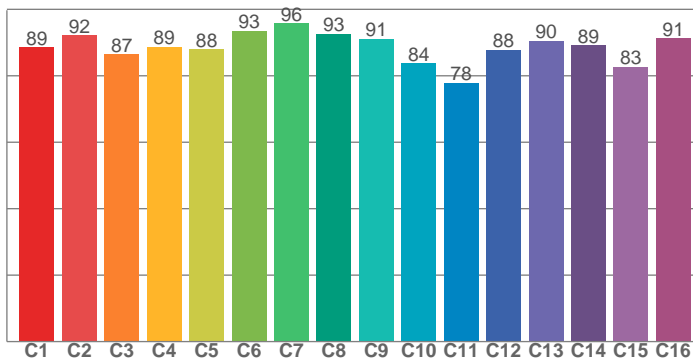

CRI: 90,5 (R1-R8)

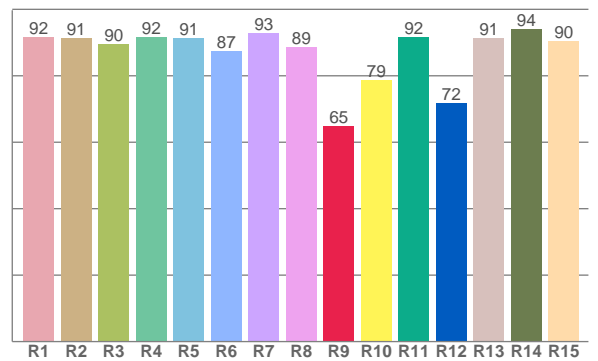

CQS: 89,6

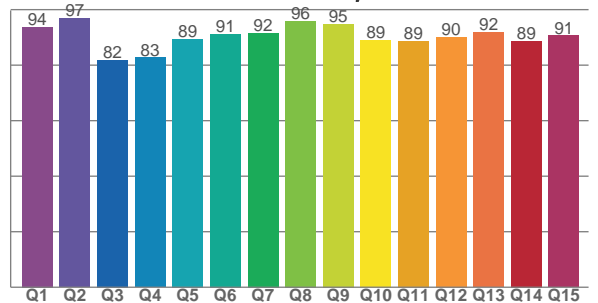

CRI R values, only R1-R8 are used to calculate final CRI value

R1	R2	R3	R4	R5	R6	R7	R8	R9	R10	R11	R12	R13	R14	R15
91,6	91,4	89,5	91,7	91,3	87,4	92,7	88,6	64,8	78,6	91,6	71,7	91,4	94,1	90,3

TM30 C values, 16 binned values out of total of 99 C values

C1	C2	C3	C4	C5	C6	C7	C8	C9	C10	C11	C12	C13	C14	C15	C16
88,6	92,1	86,5	88,7	87,9	93,5	95,8	92,6	91,2	83,7	77,8	87,9	90,5	89,2	82,6	91,3

CQS Q values

Q1	Q2	Q3	Q4	Q5	Q6	Q7	Q8	Q9	Q10	Q11	Q12	Q13	Q14	Q15
93,8	96,9	81,9	82,8	89,4	91,2	91,6	95,9	94,8	89,1	88,7	90,2	91,8	88,6	90,6

COLOR PARAMETERS

Color temperature	Color rendering index	Red component	Color fidelity	Color gamut	Color quality scale	Television lighting index	Color coordinate cie 1931	Color coordinate cie 1931	Color deviation from black body
CCT	CRI	CRI R9	TM30 Rf	TM30 Rg	CQS	TLCI	x	y	Δuv
5817 K	90,5	64,8	88,4	100,8	89,6	93	0,326	0,340	-0,0008

# TM30 DETAILS

**Rf 88,4**  
Fidelity index Rf

**Rg 100,8**  
Gammut index

Hue Bin	R <sub>f</sub>	Graphic shifts (%)	
		Chroma	Hue
1	89	-5%	-2%
2	92	-4%	2%
3	87	-2%	7%
4	89	1%	6%
5	88	2%	4%
6	93	4%	0%
7	96	1%	-2%
8	93	-3%	-2%
9	91	-5%	3%
10	84	-4%	8%
11	78	1%	12%
12	88	3%	7%
13	90	7%	2%
14	89	5%	-2%
15	83	9%	-12%
16	91	-1%	-5%

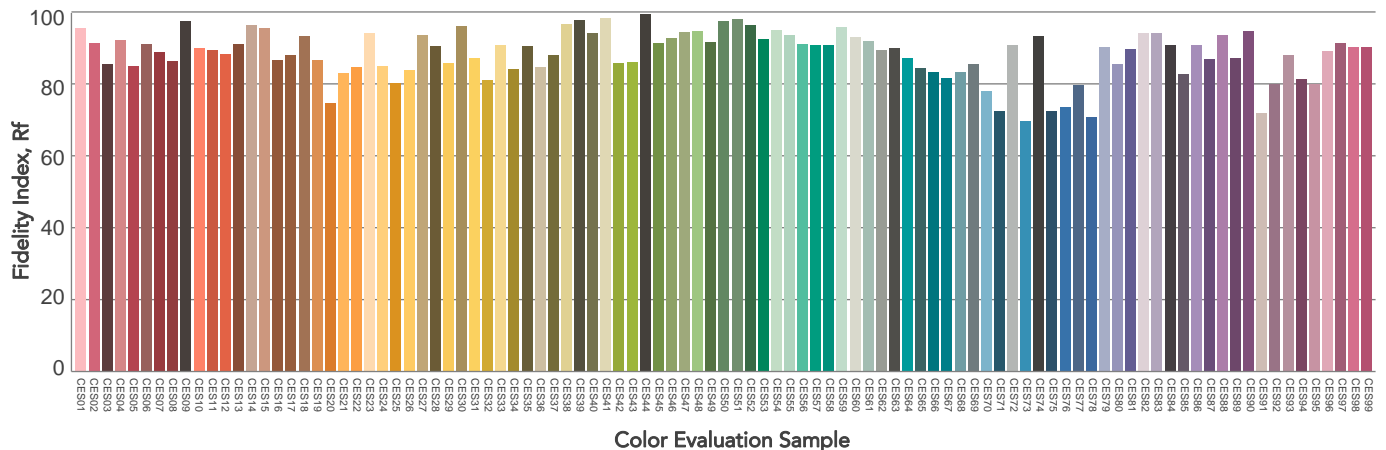
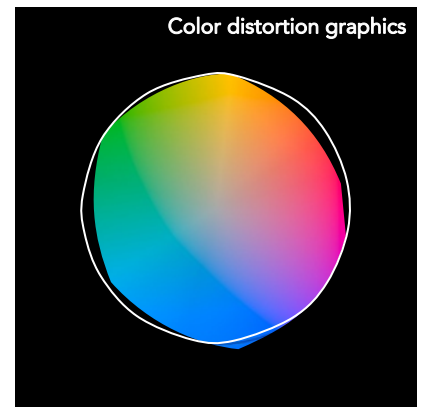
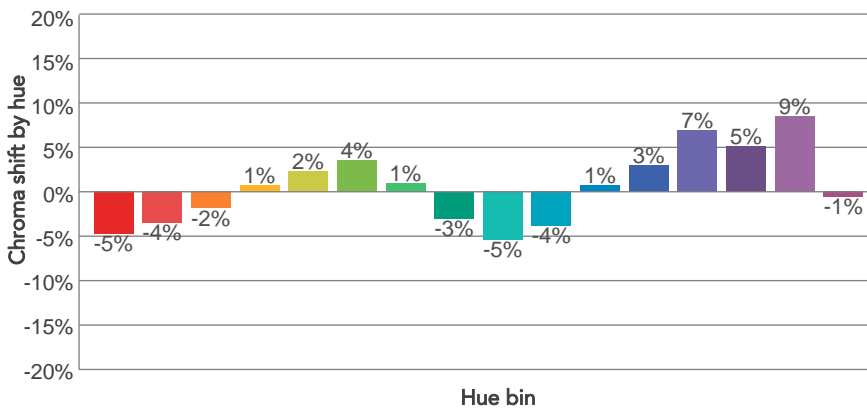
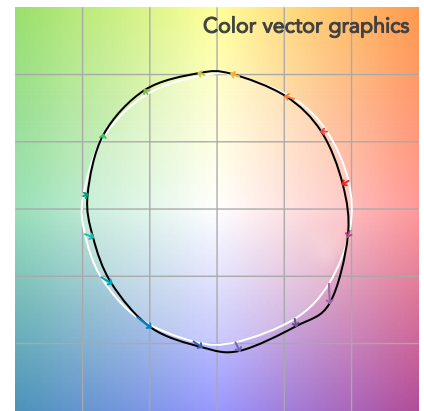
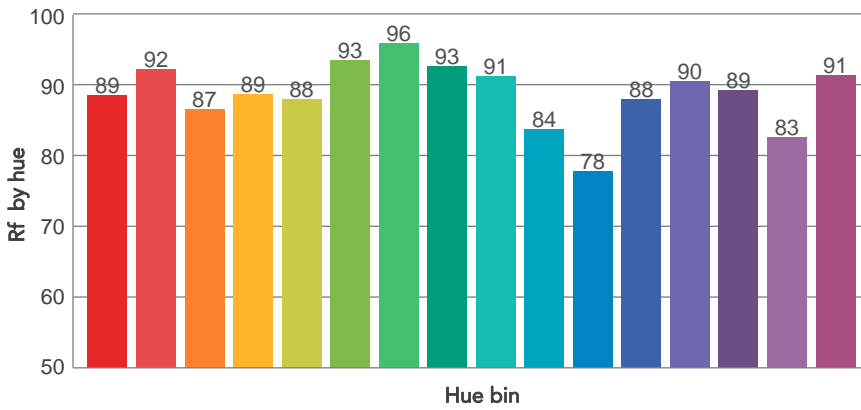
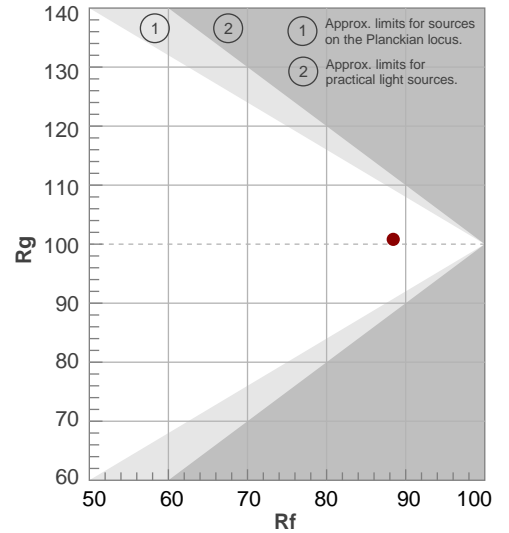

# BEAM DETAILS



Beam angle 50%	Field angle 10%	Cut off angle 2,5%	Intensity ratio in 120° cone	Intensity ratio in 90° cone
37,7°	41,7°	43,2°	100,0%	100,0%

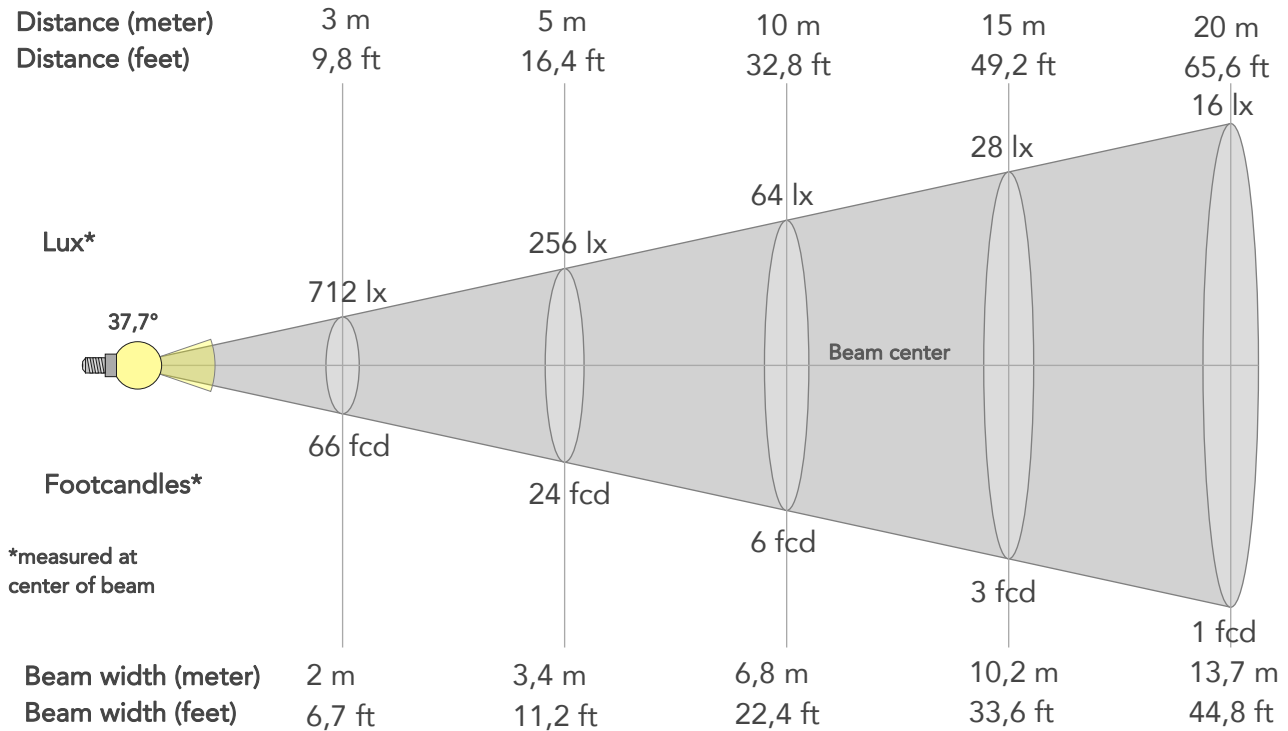

## BEAM INTENSITIES AND WIDTHS

Distance	1m	2m	3m	4m	5m	7,5m	10m	15m	20m	25m	30m	40m	50m
Distance	3,3ft	6,6ft	9,8ft	13,1ft	16,4ft	24,6ft	32,8ft	49,2ft	65,6ft	82ft	98,4ft	131,2ft	164ft
Lux	6408lx	1602lx	712lx	401lx	256lx	114lx	64lx	28lx	16lx	10lx	7lx	4lx	3lx
Footcand.	595fcd	149fcd	66fcd	37fcd	24fcd	11fcd	6fcd	3fcd	1fcd	1fcd	1fcd	0fcd	0fcd
Beam wid.	0,7m	1,4m	2m	2,7m	3,4m	5,1m	6,8m	10,2m	13,7m	17,1m	20,5m	27,3m	34,2m
Beam wid.	2,3ft	4,5ft	6,7ft	9ft	11,2ft	16,8ft	22,4ft	33,6ft	44,8ft	56ft	67,2ft	89,6ft	112ft

## LINEAR DISTRIBUTION DIAGRAM

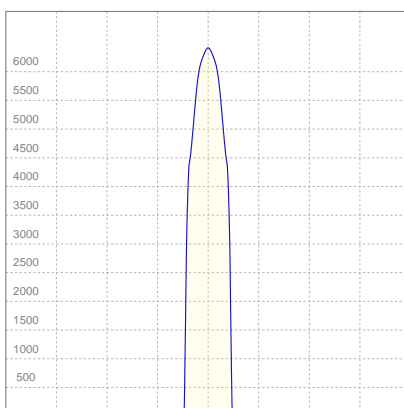

## ELECTRICAL SPECIFICATIONS

Input voltage	Input current	Input power	Effeciency
222V	0,172A	34,9W	54lm/W

Power Fc
0,94

## ISO CANDELA DIAGRAM

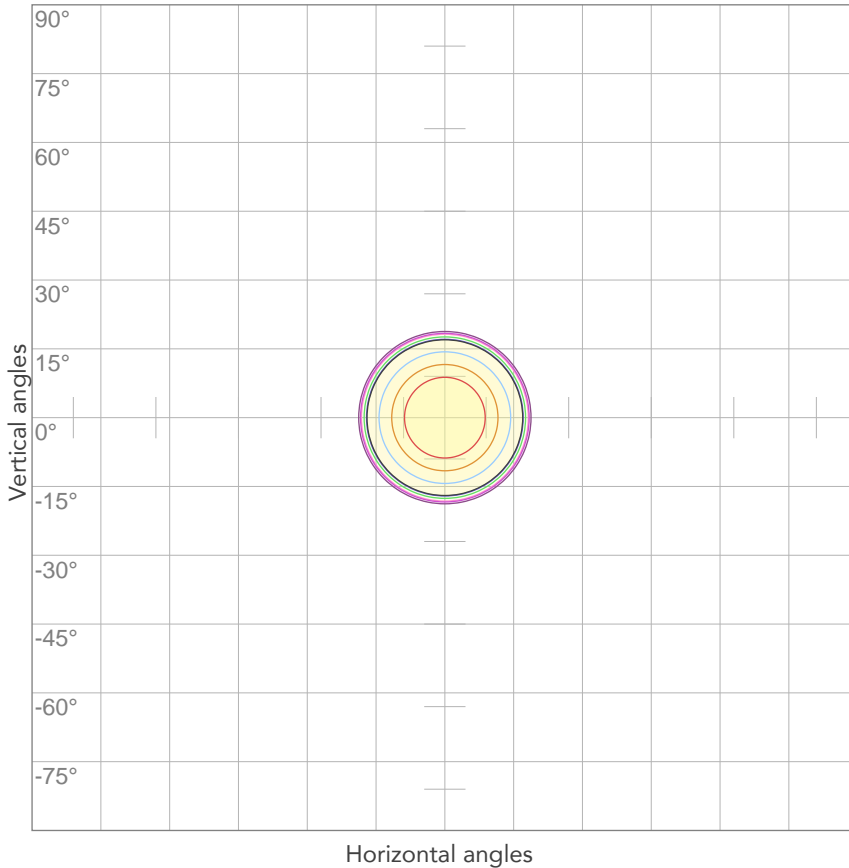

10%	641 cd
20%	1282 cd
30%	1923 cd
40%	2563 cd
50%	3204 cd
60%	3845 cd
70%	4486 cd
80%	5127 cd

Conditions:

Number of c-planes: 2

Candela at center: 6408 cd

## ISO LUX DIAGRAM

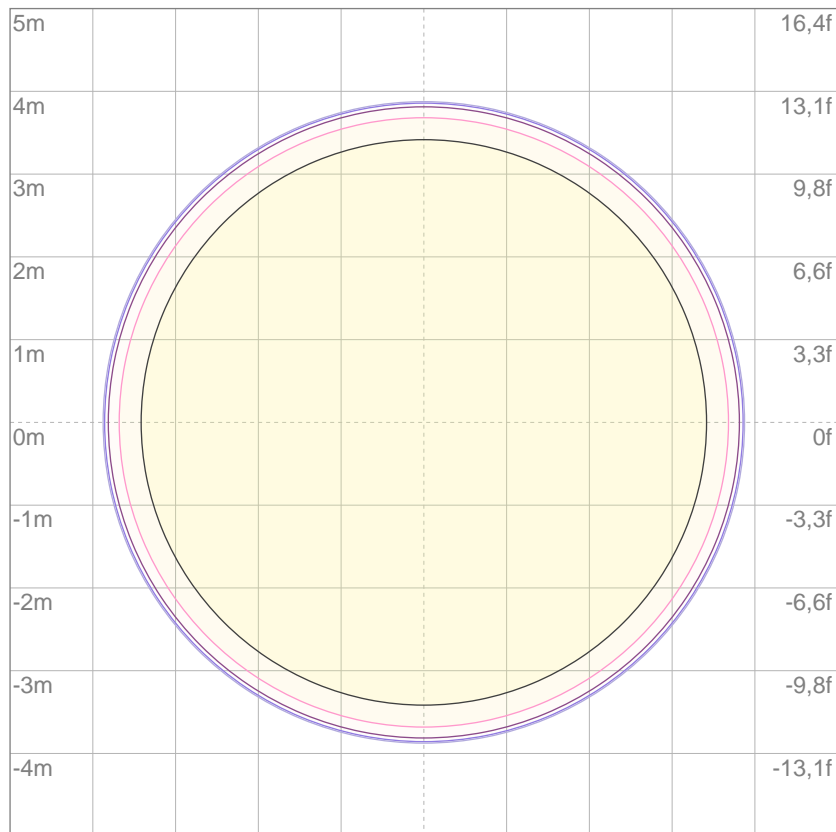

3%	1,92 lx
5%	3,20 lx
10%	6,41 lx
30%	19,2 lx
50%	32,0 lx

Conditions:

Number of c-planes: 2

Lux at center: 64,1 lx

*Lux distribution on a surface when lamp is mounted at 10 meters from the surface.*



Total lumen output:

1631 lm

Peak candela output:

24110 cd

Light quality:

CRI: 90,5

Color temperature:

5635 K

**PRODUCT NAME:**

ECLDISPLAY

**MEASURAMENT CONDITIONS:**

Beam angle:

Profile Min Zoom

Target:

5600K

Operator:

Paolo Carvone

Date and time:

22/09/2020 10:01:51

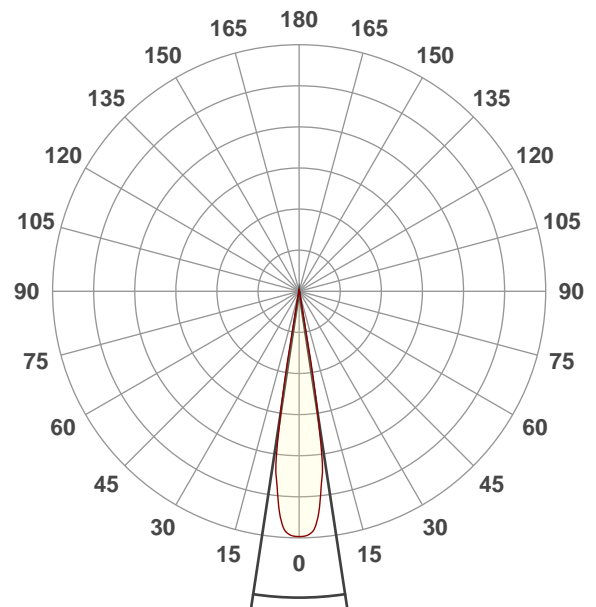

Beam angle 50%: 17,3°

Field angle 10%: 20,6°

Cut off angle 2.5%: 22°

Spectra

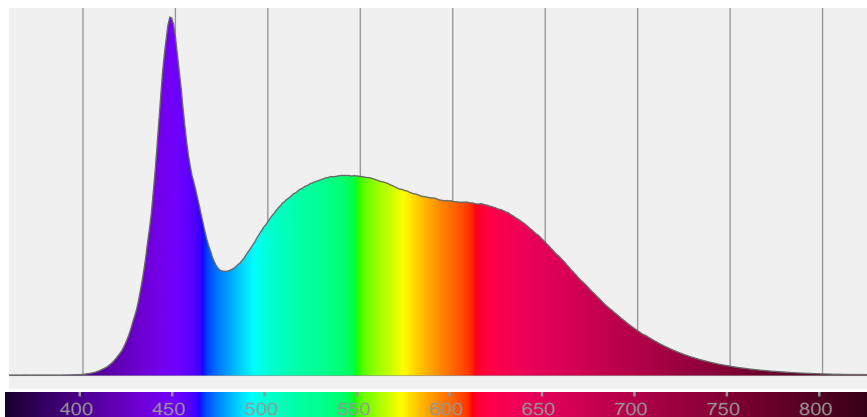

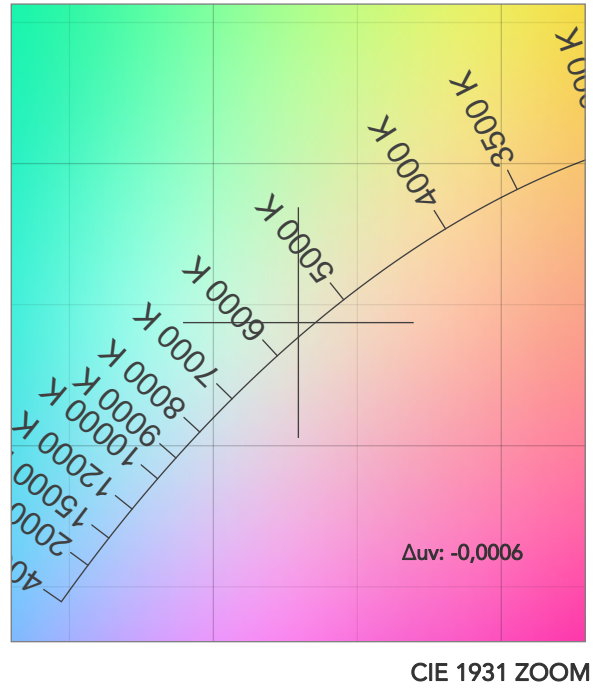
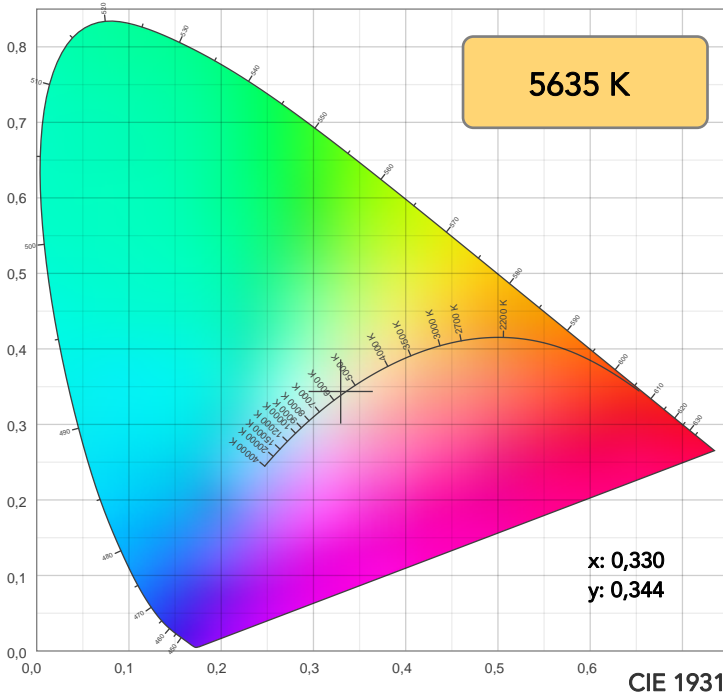

TM30: 88,5

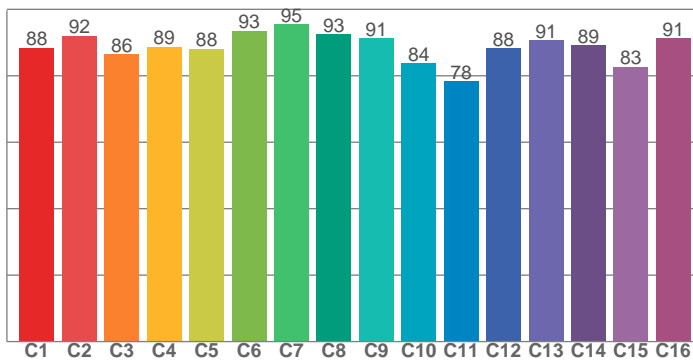

CRI: 90,5 (R1-R8)

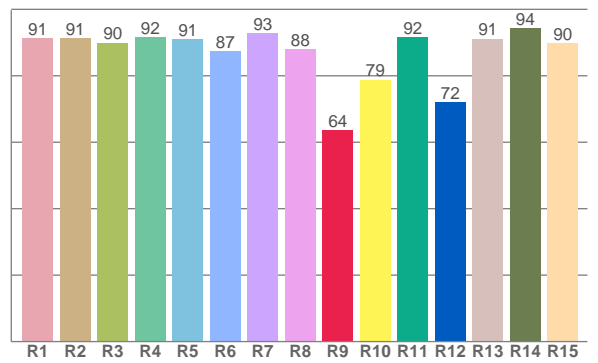

CQS: 89,6

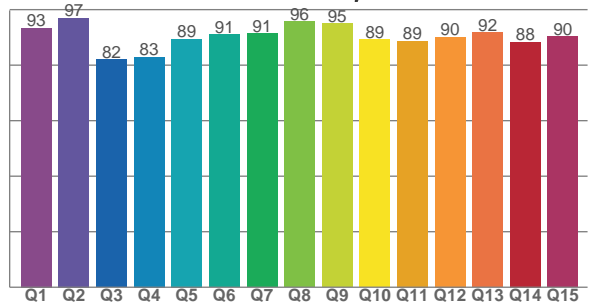

CRI R values, only R1-R8 are used to calculate final CRI value

R1	R2	R3	R4	R5	R6	R7	R8	R9	R10	R11	R12	R13	R14	R15
91,4	91,4	89,9	91,6	91,1	87,5	92,8	88,1	63,5	78,8	91,6	71,9	91,1	94,3	89,8

TM30 C values, 16 binned values out of total of 99 C values

C1	C2	C3	C4	C5	C6	C7	C8	C9	C10	C11	C12	C13	C14	C15	C16
88,3	92,0	86,4	88,8	88,1	93,5	95,5	92,5	91,2	83,8	78,3	88,3	90,6	89,2	82,7	91,2

CQS Q values

Q1	Q2	Q3	Q4	Q5	Q6	Q7	Q8	Q9	Q10	Q11	Q12	Q13	Q14	Q15
93,5	97,1	82,1	83,0	89,3	91,0	91,4	95,7	95,0	89,2	88,8	90,2	91,7	88,3	90,2

COLOR PARAMETERS

Color temperature	Color rendering index	Red component	Color fidelity	Color gamut	Color quality scale	Television lighting index	Color coordinate cie 1931	Color coordinate cie 1931	Color deviation from black body
CCT	CRI	CRI R9	TM30 Rf	TM30 Rg	CQS	TLCI	x	y	$\Delta uv$
5635 K	90,5	63,5	88,5	100,6	89,6	93	0,330	0,344	-0,0006



# TM30 DETAILS

**Rf 88,5**  
Fidelity index Rf

**Rg 100,6**  
Gammut index

Hue Bin	R <sub>f</sub>	Graphic shifts (%)	
		Chroma	Hue
1	88	-5%	-2%
2	92	-4%	2%
3	86	-2%	7%
4	89	1%	6%
5	88	2%	4%
6	93	4%	0%
7	95	0%	-2%
8	93	-3%	-2%
9	91	-5%	3%
10	84	-4%	8%
11	78	1%	12%
12	88	3%	6%
13	91	7%	2%
14	89	5%	-2%
15	83	8%	-12%
16	91	-1%	-5%

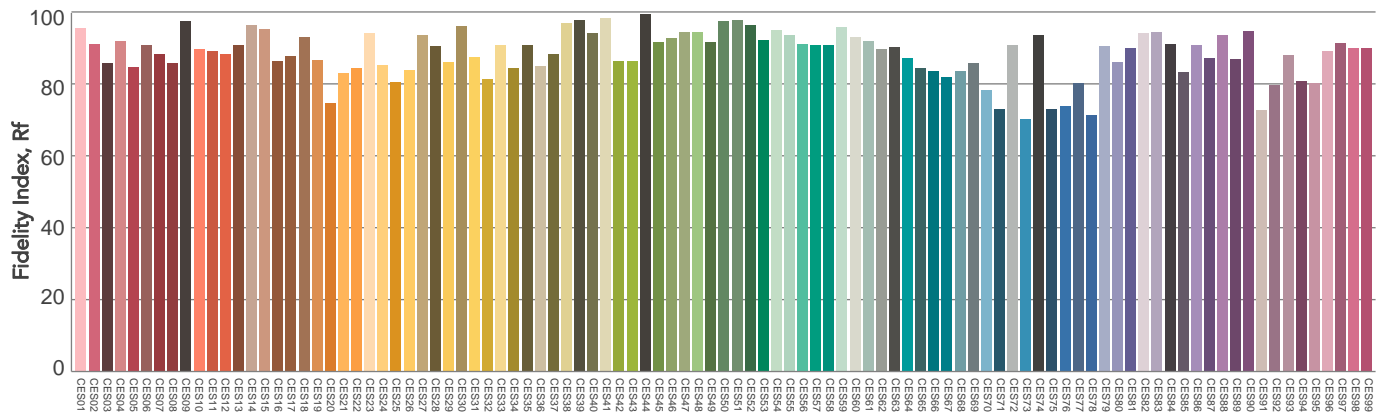
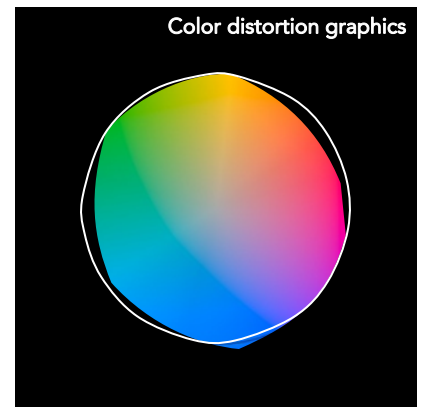
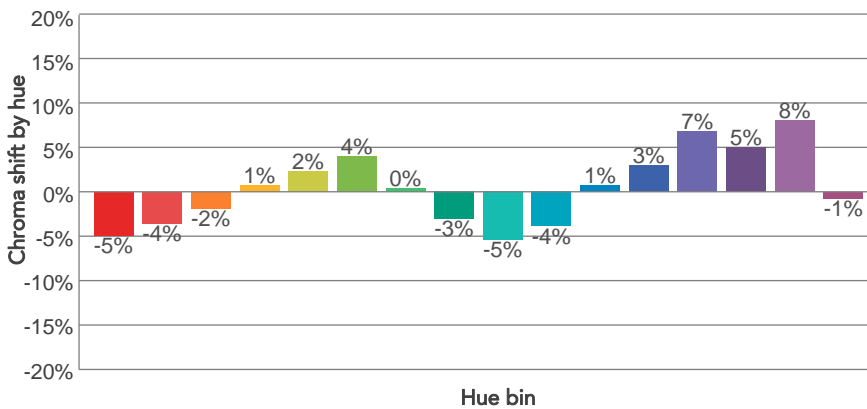
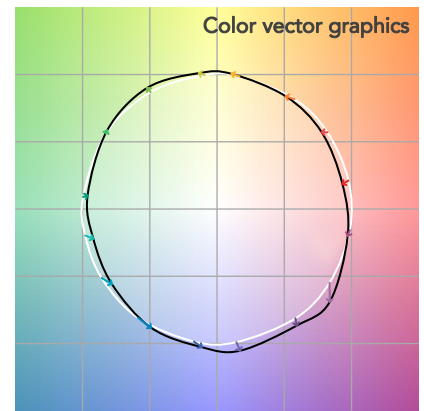
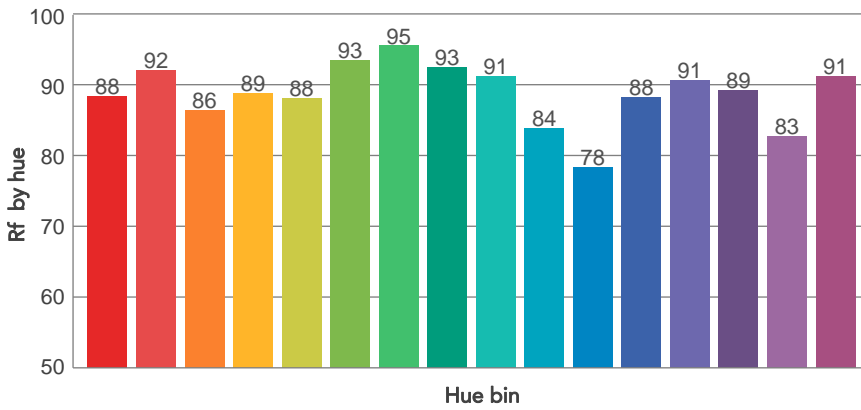
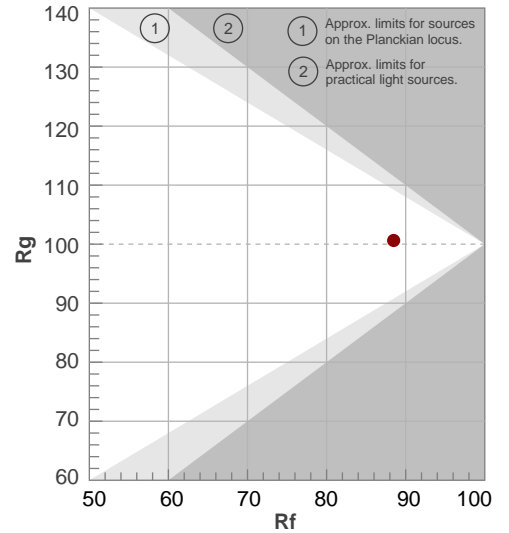

# BEAM DETAILS



Beam angle 50%	Field angle 10%	Cut off angle 2,5%	Intensity ratio in 120° cone	Intensity ratio in 90° cone
17,3°	20,6°	22°	100,0%	100,0%

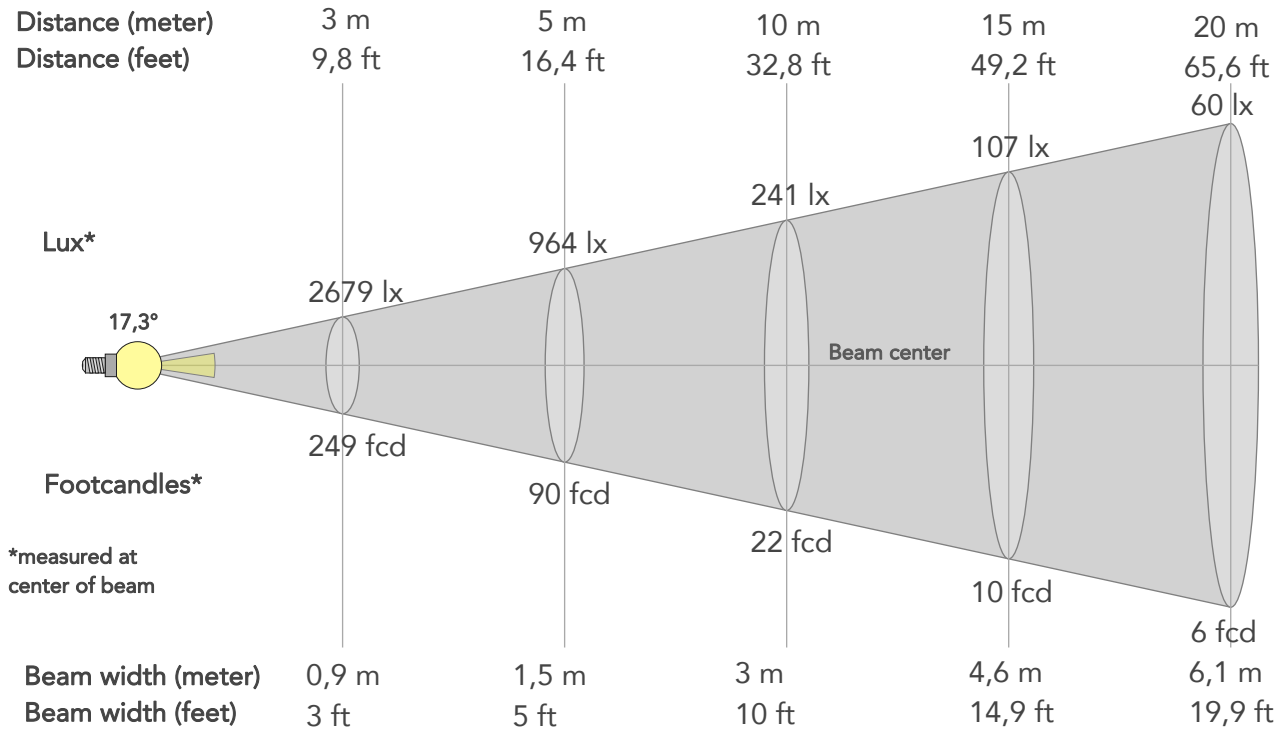

## BEAM INTENSITIES AND WIDTHS

Distance	1m	2m	3m	4m	5m	7,5m	10m	15m	20m	25m	30m	40m	50m
Distance	3,3ft	6,6ft	9,8ft	13,1ft	16,4ft	24,6ft	32,8ft	49,2ft	65,6ft	82ft	98,4ft	131,2ft	164ft
Lux	24110lx	6027lx	2679lx	1507lx	964lx	429lx	241lx	107lx	60lx	39lx	27lx	15lx	10lx
Footcand.	2240fcd	560fcd	249fcd	140fcd	90fcd	40fcd	22fcd	10fcd	6fcd	4fcd	2fcd	1fcd	1fcd
Beam wid.	0,3m	0,6m	0,9m	1,2m	1,5m	2,3m	3m	4,6m	6,1m	7,6m	9,1m	12,1m	15,2m
Beam wid.	1ft	2ft	3ft	4ft	5ft	7,5ft	10ft	14,9ft	19,9ft	24,9ft	29,9ft	39,8ft	49,8ft

## LINEAR DISTRIBUTION DIAGRAM

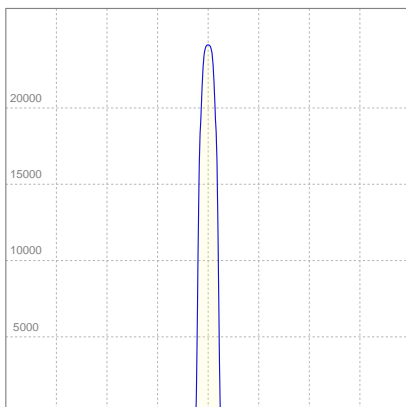

## ELECTRICAL SPECIFICATIONS

Input voltage	Input current	Input power	Effeciency
222V	0,172A	34,8W	47lm/W

Power Fc
0,94

## ISO CANDELA DIAGRAM

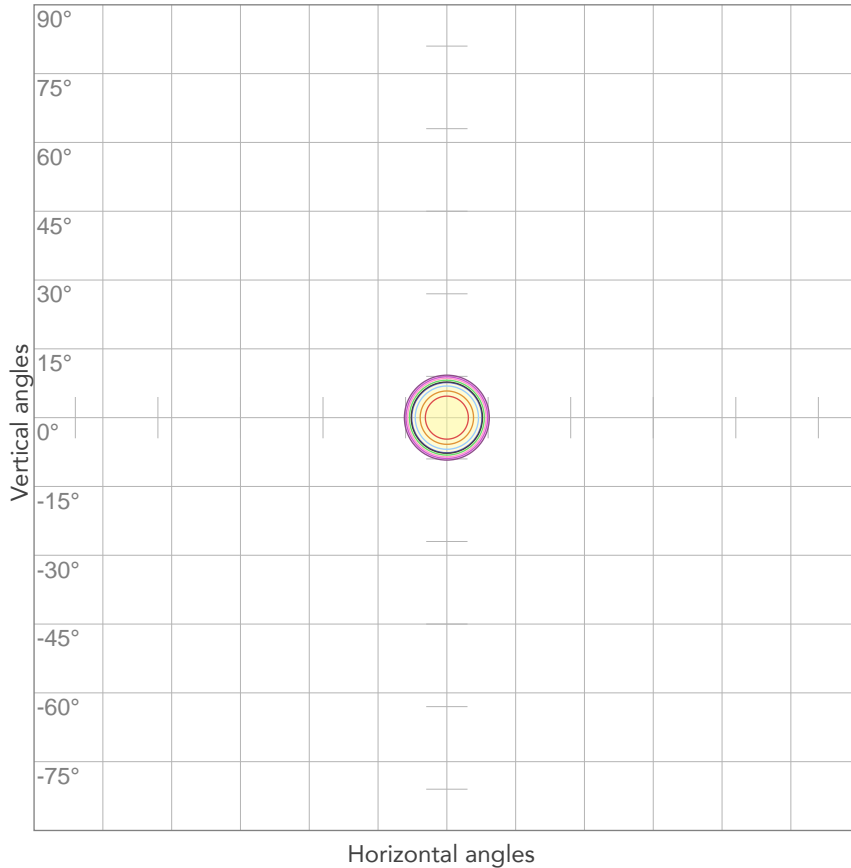

10%	2411 cd
20%	4822 cd
30%	7233 cd
40%	9644 cd
50%	12055 cd
60%	14466 cd
70%	16877 cd
80%	19288 cd

Conditions:

Number of c-planes: 2

Candela at center: 24110 cd

## ISO LUX DIAGRAM

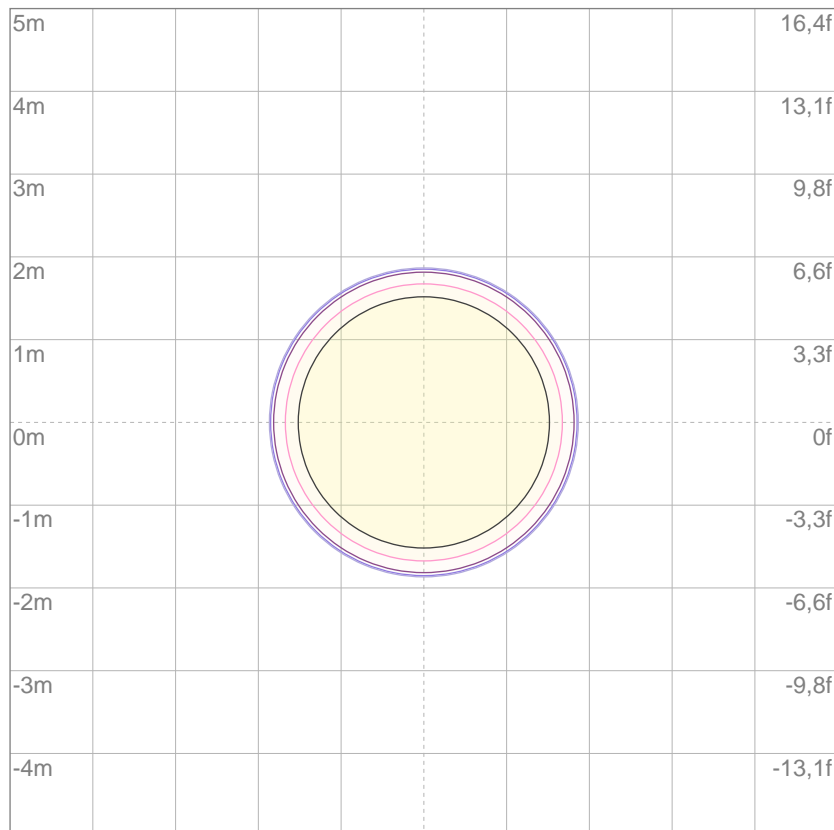

3%	7,23 lx
5%	12,1 lx
10%	24,1 lx
30%	72,3 lx
50%	121 lx

Conditions:

Number of c-planes: 2

Lux at center: 241 lx

*Lux distribution on a surface when lamp is mounted at 10 meters from the surface.*

Mounting height: 10 meters (33 feet)