

Photometric Test Report



ECLDISPLAYDAT

ZOOMABLE WASH LENS 15-30°

25W White LED gallery light, with data control

DMX / Dali / Knob-dimming

CONTENTS

Table of contents	2
Testing process	3
Color temperature 2700K Max Zoom	4
Color temperature 2700K Min Zoom	9
Color temperature 3000K Max Zoom	14
Color temperature 3000K Min Zoom	19
Color temperature 4000K Max Zoom	24
Color temperature 4000K Min Zoom	29
Color temperature 5600K Max Zoom	34
Color temperature 5600K Min Zoom	39

TESTING PROCESS

Prolights has its own optical testing laboratory in order to provide accurate photometric reports for its lighting products. The testing laboratory contains certain variety of precise lighting measurement systems that ensure an optimal reading of all the characteristic parameters of the lighting devices. All measurements are made at a controlled room temperature of 20°C without any external light sources. This photometric report is obtained through the data measured by a high precision measurement system and analyzed by a dedicate software.

Prolights measurement instrument

Prolights measurement instrument is a complete measurement system for any light source. It's equipped with two-axis goniometer, that enables to measure the full 3D distribution field of the light source. This instrument measures the light intensity, the beam angle and the most significative colors parameters, like color temperature, spectral distribution, CRI, CQS, TM-30 with a very high accuracy rate.

Please Note: All measurements are made with light source at operating temperature. Before starting the measurement, the instrument analyzes the process of the light source during the heating phase. The measuring process of all the parameters begins only when the light emission is stable, that is with a variation of less than 0.5% in a 15 minutes time frame.

Prolights measurement software

The software provides user friendly interface for the operator who does the measurements, and it also analyzes and processes all the collected data by the instrument. With this software it is possible to see the measured data in real-time and it is possible to examine all the measured data and graphics afterwards as well. All information is collected in a specific Prolights template, and the software creates also IES and LDT files, which are widely used to transfer the photometric data, and to develop lighting system.

Additionally, the fixtures are rechecked using various hand-held instruments like Sekonic C-700 and Gossen Mavospec Base, this is done to ensure, that the data in the photometric report are as accurate as possible.



Total lumen output:

1527 lm

Peak candela output:

5859 cd

Light quality:

CRI: 90,9

Color temperature:

2806 K

PRODUCT NAME:
ECLDISPLAY

MEASURAMENT CONDITIONS:

Beam angle:
Wash 15-30 Max Zoom

Target:
2700K

Operator:
Paolo Carvone

Date and time:
19/01/2021 17:25:30

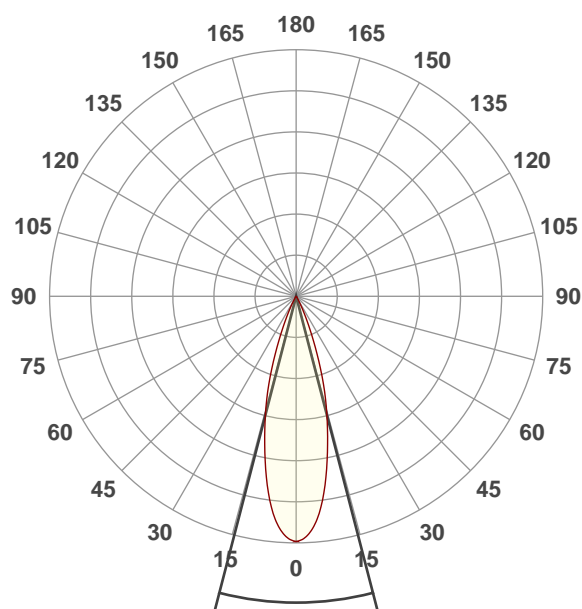

Beam angle 50%: 29°
Field angle 10%: 48,7°
Cut off angle 2.5%: 58,4°

Spectra

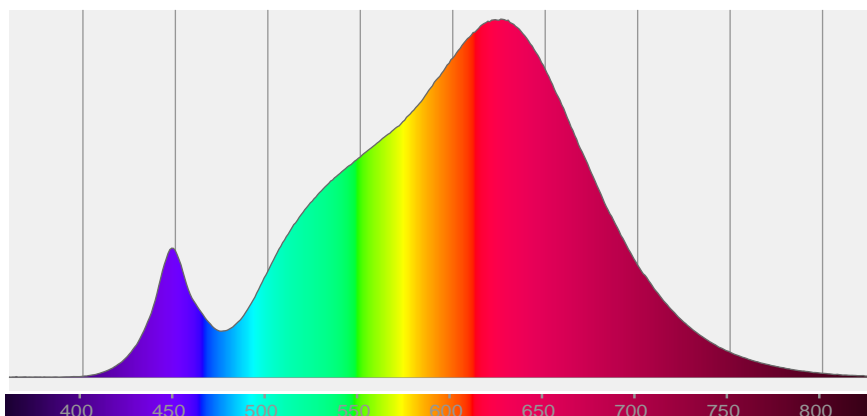

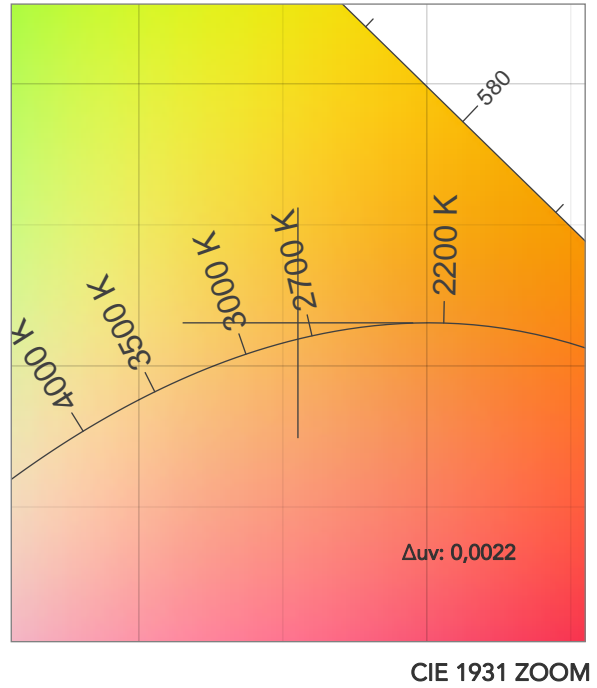
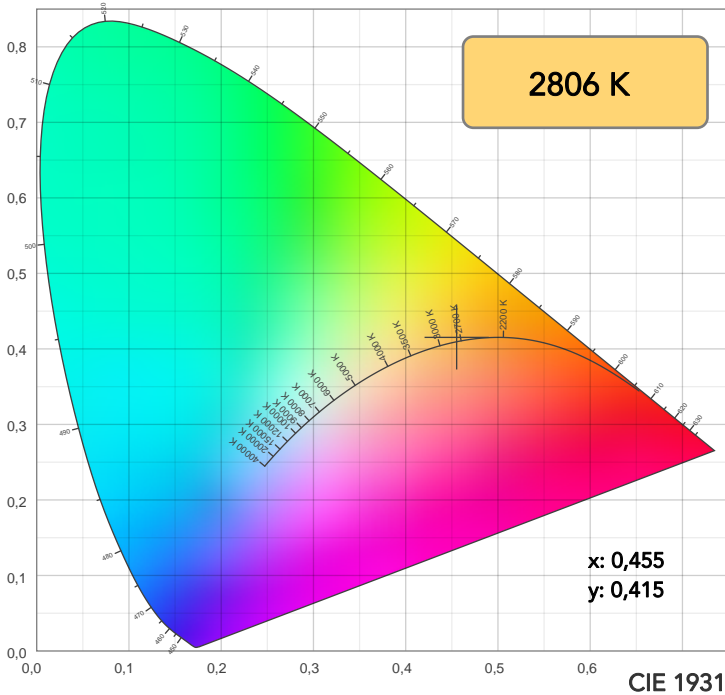

TM30: 89,6

CRI: 90,9 (R1-R8)

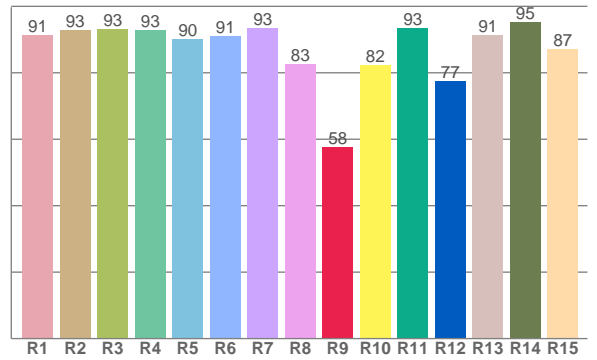
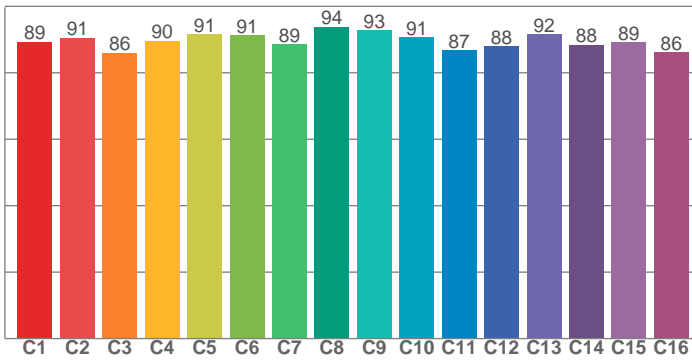

CRI R values, only R1-R8 are used to calculate final CRI value

R1	R2	R3	R4	R5	R6	R7	R8	R9	R10	R11	R12	R13	R14	R15
91,3	92,9	93,0	92,8	90,1	91,0	93,5	82,6	57,7	82,3	93,4	77,4	91,4	95,1	87,0

TM30 C values, 16 binned values out of total of 99 C values

C1	C2	C3	C4	C5	C6	C7	C8	C9	C10	C11	C12	C13	C14	C15	C16
89,3	90,6	86,0	89,6	91,5	91,3	88,5	93,8	92,7	90,7	86,8	88,0	91,6	88,3	89,1	86,2

CQS Q values

Q1	Q2	Q3	Q4	Q5	Q6	Q7	Q8	Q9	Q10	Q11	Q12	Q13	Q14	Q15
86,5	96,4	87,6	88,3	88,9	87,1	88,6	92,6	95,9	91,9	91,5	92,0	92,2	85,4	85,7

CQS: 89,4

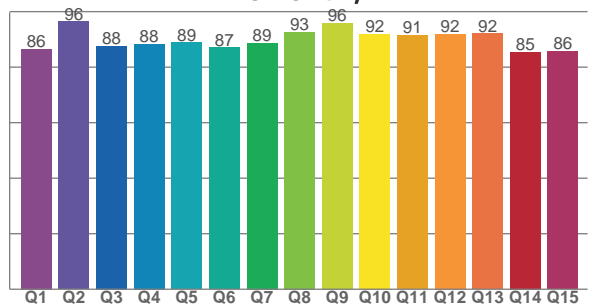

COLOR PARAMETERS

Color temperature	Color rendering index	Red component	Color fidelity	Color gamut	Color quality scale	Television lighting index	Color coordinate cie 1931	Color coordinate cie 1931	Color deviation from black body
CCT	CRI	CRI R9	TM30 Rf	TM30 Rg	CQS	TLCI	x	y	Δuv
2806 K	90,9	57,7	89,6	100,6	89,4	88	0,455	0,415	0,0022

TM30 DETAILS

Rf 89,6
Fidelity index Rf

Rg 100,6
Gammut index

Hue Bin	R _f	Graphic shifts (%)	
		Chroma	Hue
1	89	-5%	-2%
2	91	-4%	3%
3	86	-2%	6%
4	90	2%	6%
5	91	4%	5%
6	91	5%	0%
7	89	2%	-6%
8	94	0%	-4%
9	93	-3%	-2%
10	91	-4%	3%
11	87	-2%	8%
12	88	4%	4%
13	92	4%	-2%
14	88	5%	-6%
15	89	1%	-6%
16	86	-2%	-9%

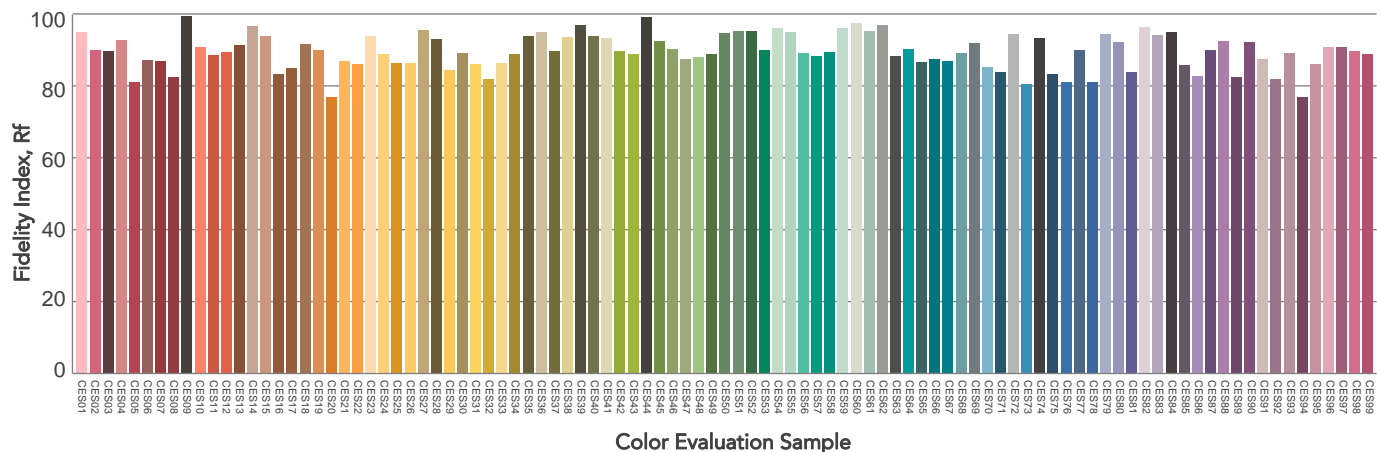
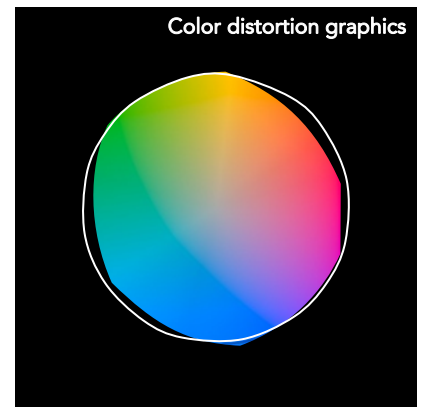
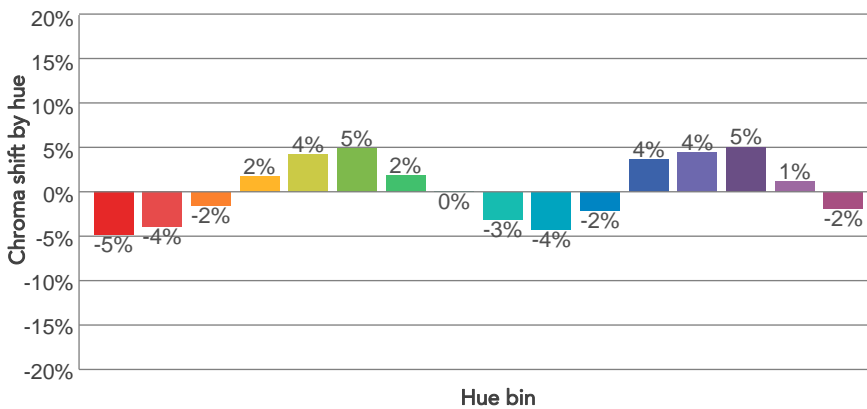
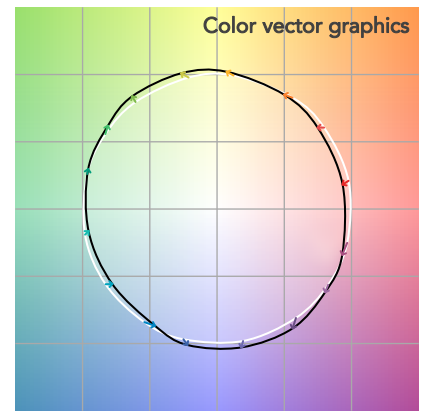
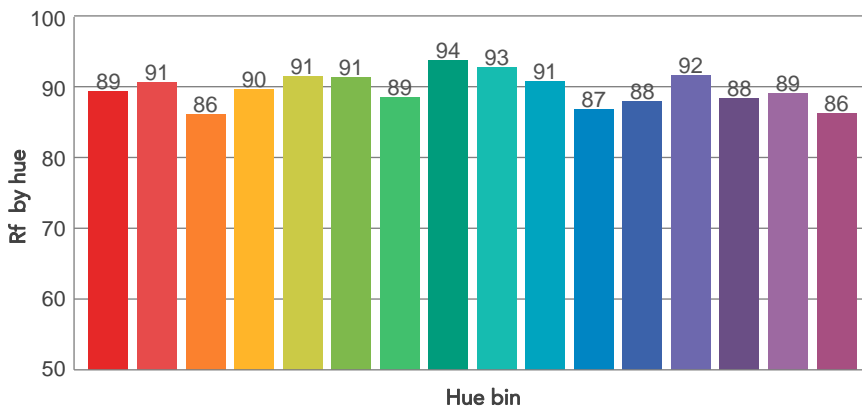
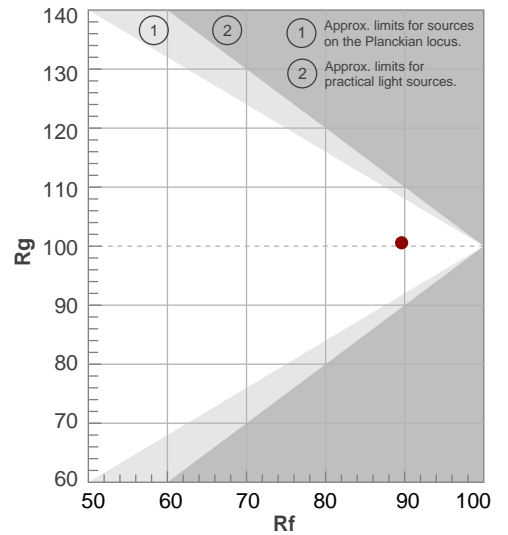

BEAM DETAILS



Beam angle 50%	Field angle 10%	Cut off angle 2,5%	Intensity ratio in 120° cone	Intensity ratio in 90° cone
29°	48,7°	58,4°	99,9%	99,5%

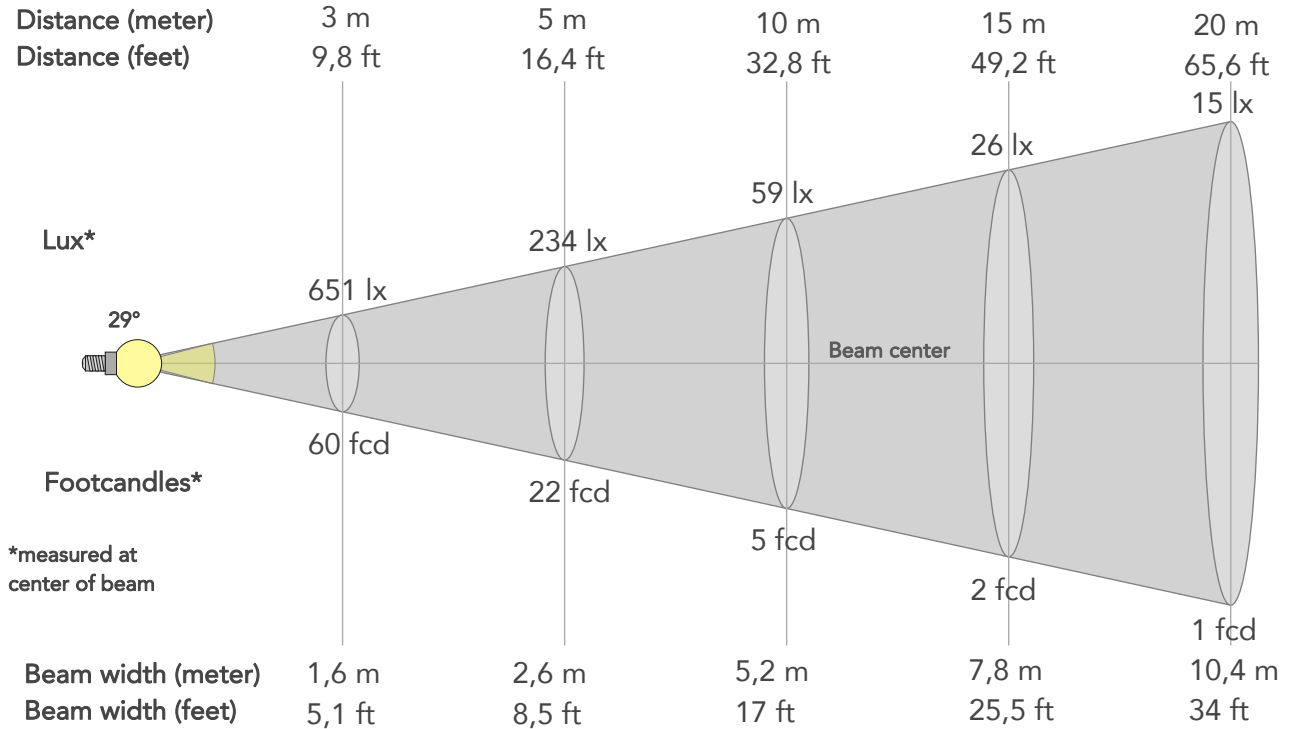

BEAM INTENSITIES AND WIDTHS

Distance	1m	2m	3m	4m	5m	7,5m	10m	15m	20m	25m	30m	40m	50m
Distance	3,3ft	6,6ft	9,8ft	13,1ft	16,4ft	24,6ft	32,8ft	49,2ft	65,6ft	82ft	98,4ft	131,2ft	164ft
Lux	5859lx	1465lx	651lx	366lx	234lx	104lx	59lx	26lx	15lx	9lx	7lx	4lx	2lx
Footcand.	544fcd	136fcd	60fcd	34fcd	22fcd	10fcd	5fcd	2fcd	1fcd	1fcd	1fcd	0fcd	0fcd
Beam wid.	0,5m	1m	1,6m	2,1m	2,6m	3,9m	5,2m	7,8m	10,4m	12,9m	15,5m	20,7m	25,9m
Beam wid.	1,7ft	3,4ft	5,1ft	6,8ft	8,5ft	12,7ft	17ft	25,5ft	34ft	42,5ft	51ft	68ft	84,9ft

LINEAR DISTRIBUTION DIAGRAM

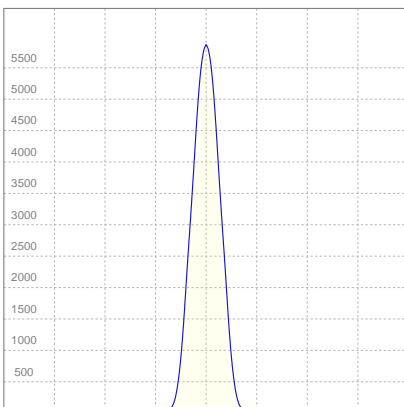

ELECTRICAL SPECIFICATIONS

Input voltage	Input current	Input power	Effeciency
223V	0,160A	33,5W	46lm/W
Power Fc			
0,94			

ISO CANDELA DIAGRAM

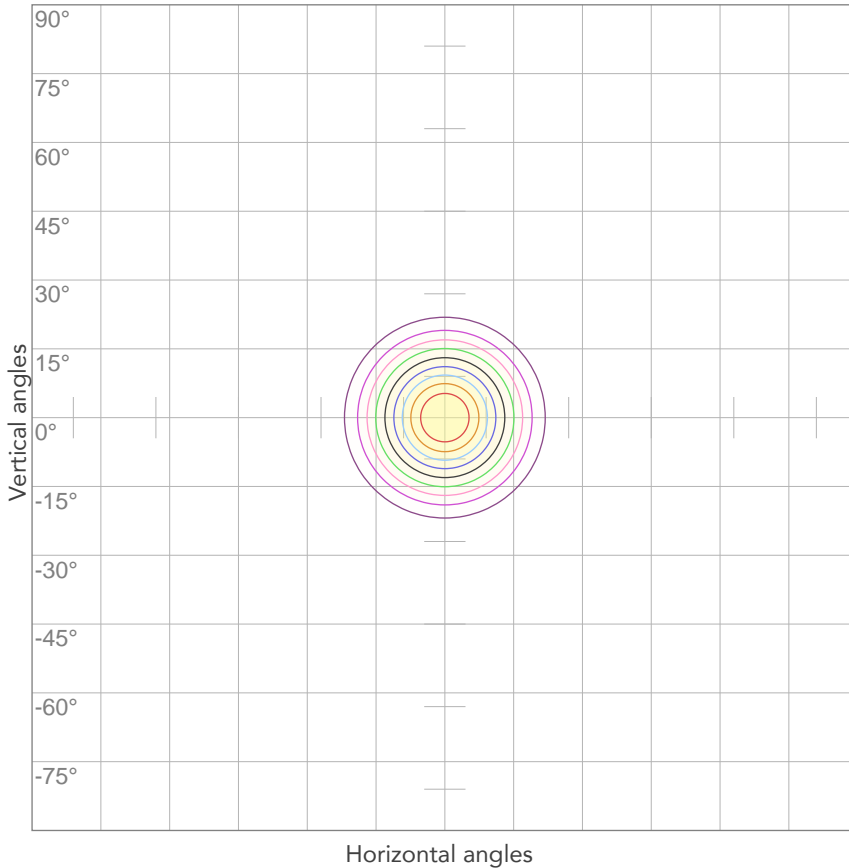

10%	586 cd
20%	1172 cd
30%	1758 cd
40%	2344 cd
50%	2929 cd
60%	3515 cd
70%	4101 cd
80%	4687 cd

Conditions:

Number of c-planes: 2

Candela at center: 5859 cd

ISO LUX DIAGRAM

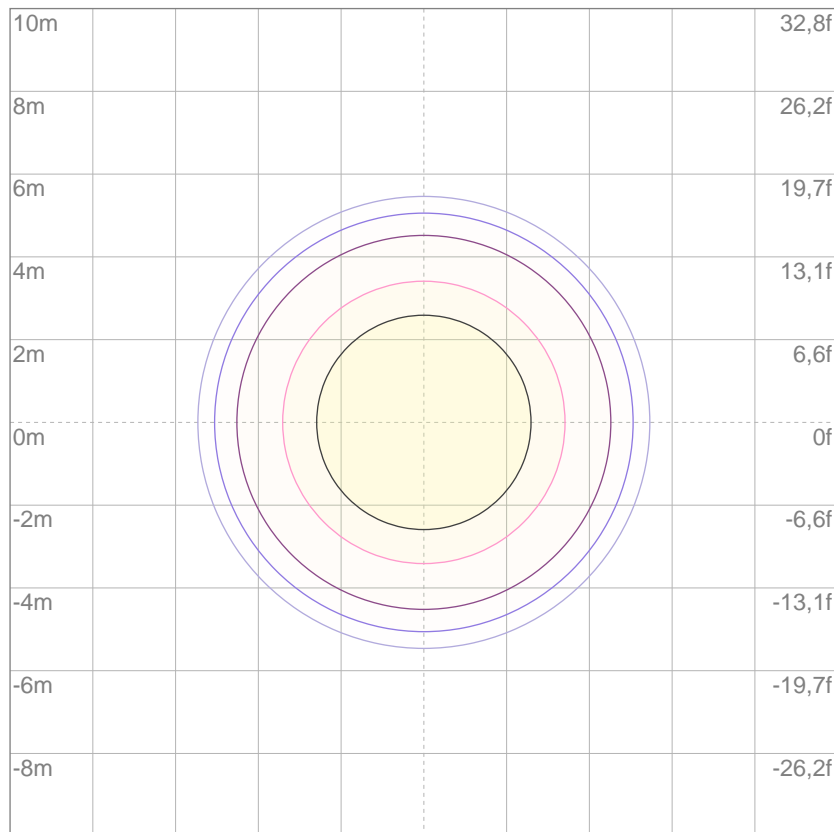

3%	1,76 lx
5%	2,93 lx
10%	5,86 lx
30%	17,6 lx
50%	29,3 lx

Conditions:

Number of c-planes: 2

Lux at center: 58,6 lx

Lux distribution on a surface when lamp is mounted at 10 meters from the surface.

Mounting height: 10 meters (33 feet)



Total lumen output:

1220 lm

Peak candela output:

17081 cd

Light quality:

CRI: 90,9

Color temperature:

2794 K

PRODUCT NAME:
ECLDISPLAY

MEASURAMENT CONDITIONS:

Beam angle:
Wash 15-30 Min Zoom

Target:
2700K

Operator:
Paolo Carvone

Date and time:
19/01/2021 17:23:19

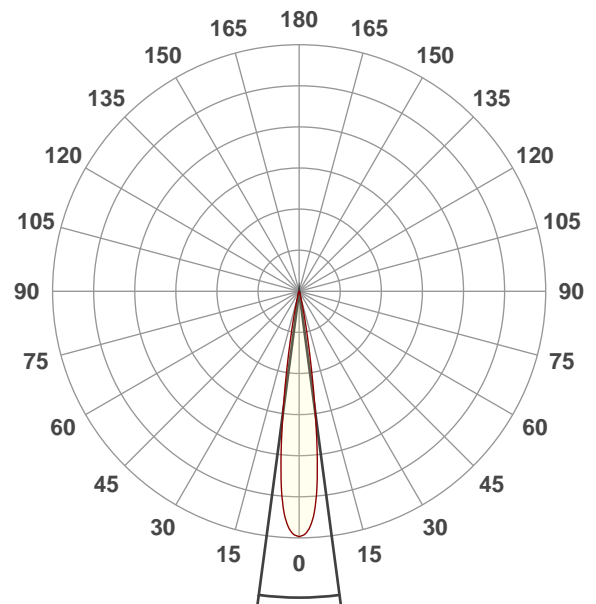

Beam angle 50%: 15,1°
Field angle 10%: 23,9°
Cut off angle 2.5%: 30,6°

Spectra



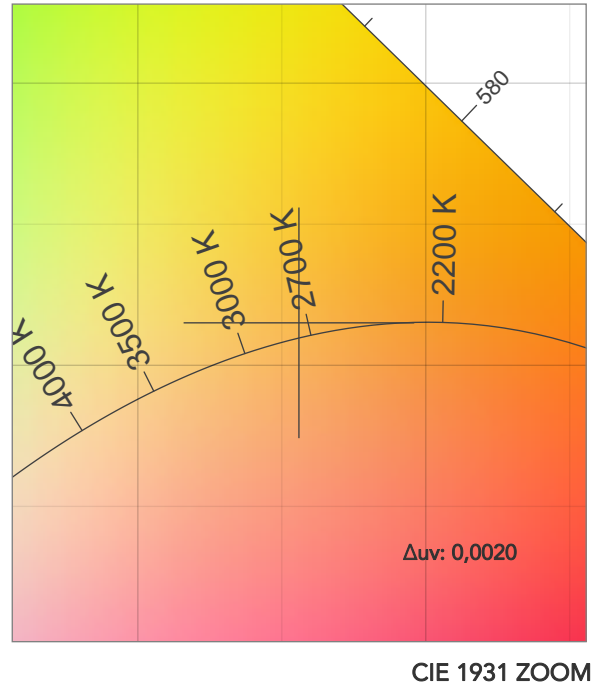
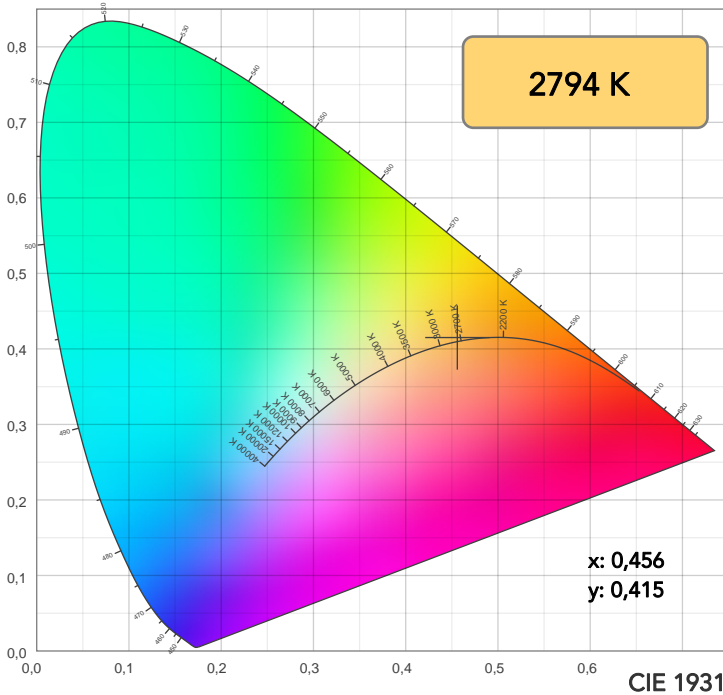

TM30: 89,5

CRI: 90,9 (R1-R8)

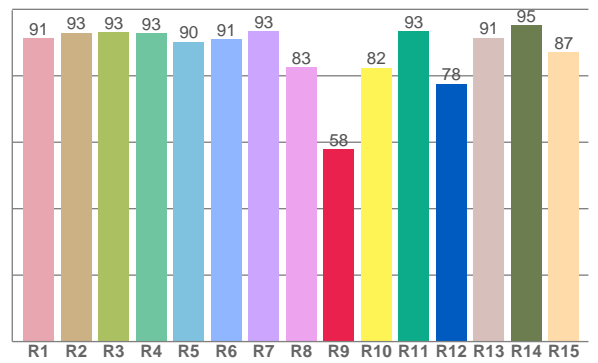
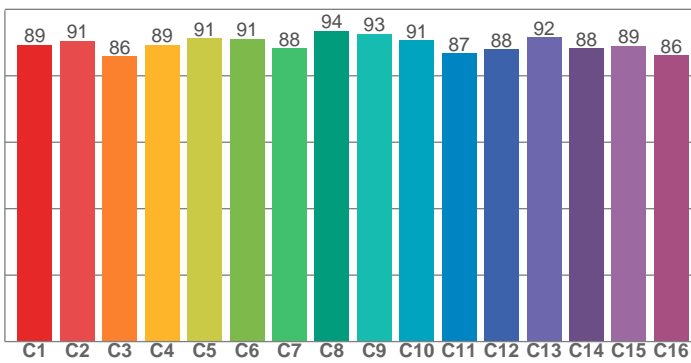

CRI R values, only R1-R8 are used to calculate final CRI value

R1	R2	R3	R4	R5	R6	R7	R8	R9	R10	R11	R12	R13	R14	R15
91,4	92,9	93,1	92,8	90,2	91,1	93,4	82,7	57,9	82,4	93,4	77,6	91,4	95,1	87,1

TM30 C values, 16 binned values out of total of 99 C values

C1	C2	C3	C4	C5	C6	C7	C8	C9	C10	C11	C12	C13	C14	C15	C16
89,3	90,6	85,9	89,4	91,3	91,0	88,2	93,5	92,6	90,7	86,8	87,9	91,5	88,3	89,0	86,2

CQS Q values

Q1	Q2	Q3	Q4	Q5	Q6	Q7	Q8	Q9	Q10	Q11	Q12	Q13	Q14	Q15
86,4	96,4	87,5	88,3	88,8	86,9	88,4	92,5	95,9	91,8	91,5	92,0	92,2	85,4	85,7

CQS: 89,3

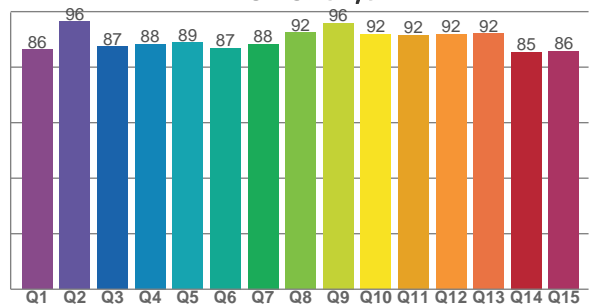

COLOR PARAMETERS

Color temperature	Color rendering index	Red component	Color fidelity	Color gamut	Color quality scale	Television lighting index	Color coordinate cie 1931	Color coordinate cie 1931	Color deviation from black body
CCT	CRI	CRI R9	TM30 Rf	TM30 Rg	CQS	TLCI	x	y	Δuv
2794 K	90,9	57,9	89,5	100,7	89,3	88	0,456	0,415	0,0020

TM30 DETAILS

Rf 89,5
Fidelity index Rf

Rg 100,7
Gammut index

Hue Bin	R _f	Graphic shifts (%)	
		Chroma	Hue
1	89	-5%	-2%
2	91	-4%	3%
3	86	-1%	6%
4	89	2%	6%
5	91	4%	5%
6	91	5%	0%
7	88	2%	-6%
8	94	0%	-4%
9	93	-3%	-2%
10	91	-4%	3%
11	87	-2%	8%
12	88	4%	4%
13	92	5%	-2%
14	88	5%	-6%
15	89	1%	-6%
16	86	-2%	-9%

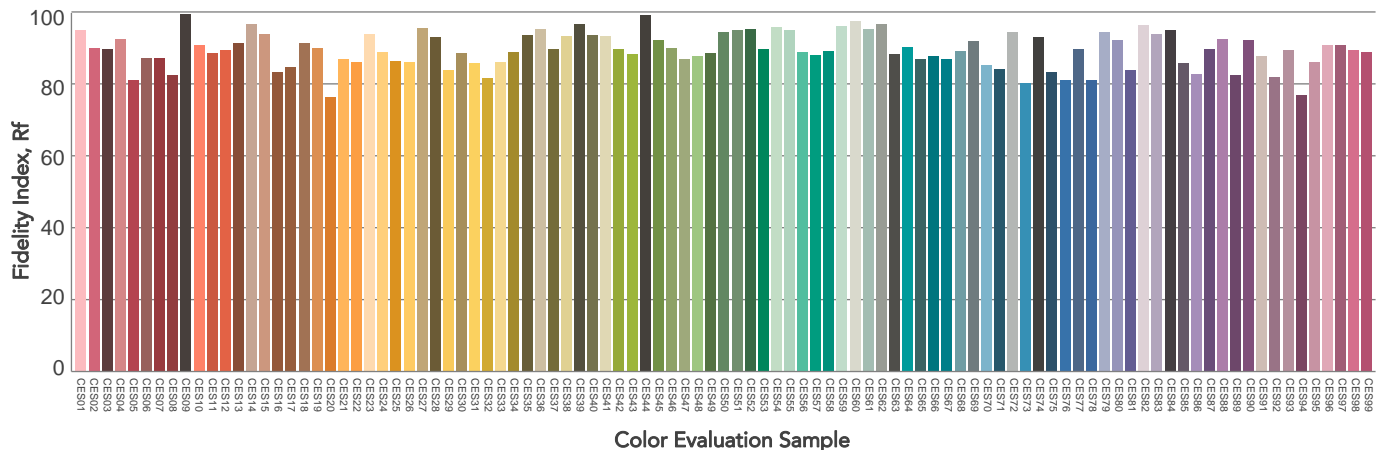
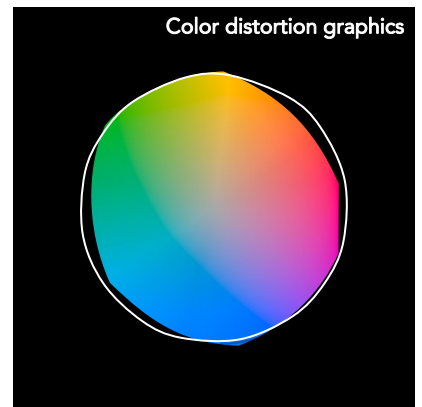
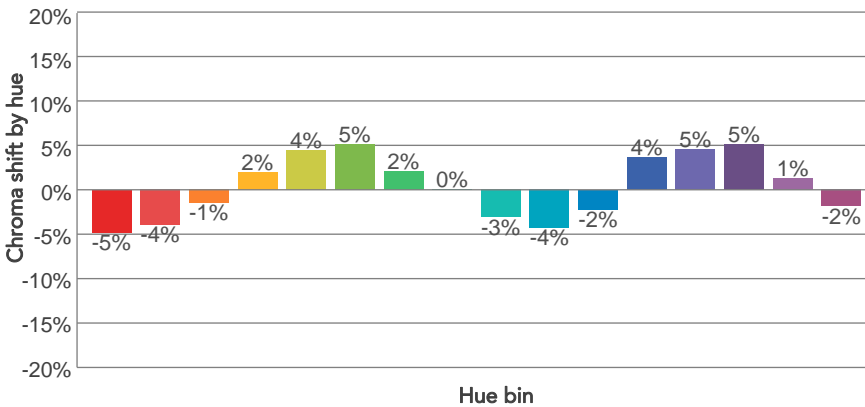
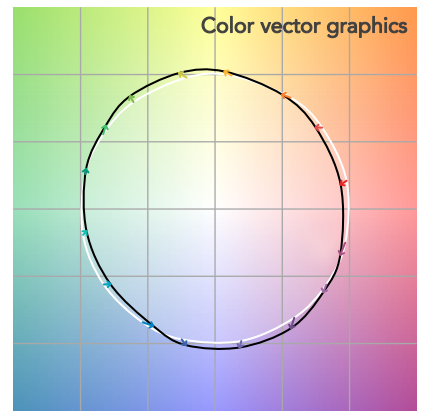
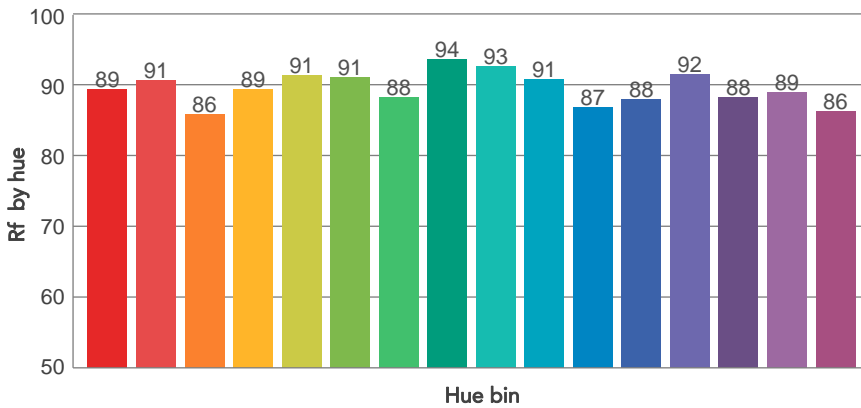
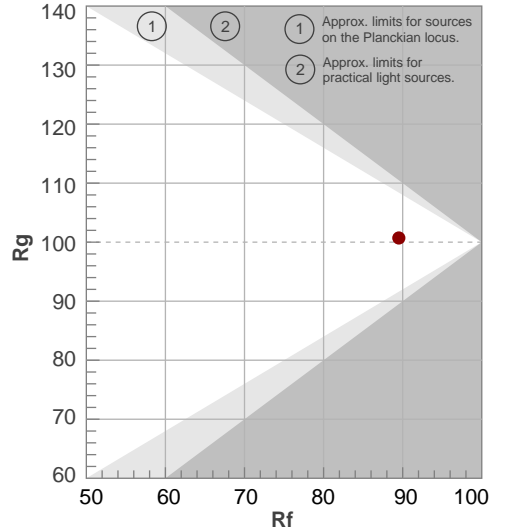

BEAM DETAILS



Beam angle 50%	Field angle 10%	Cut off angle 2,5%	Intensity ratio in 120° cone	Intensity ratio in 90° cone
15,1°	23,9°	30,6°	100,0%	100,0%

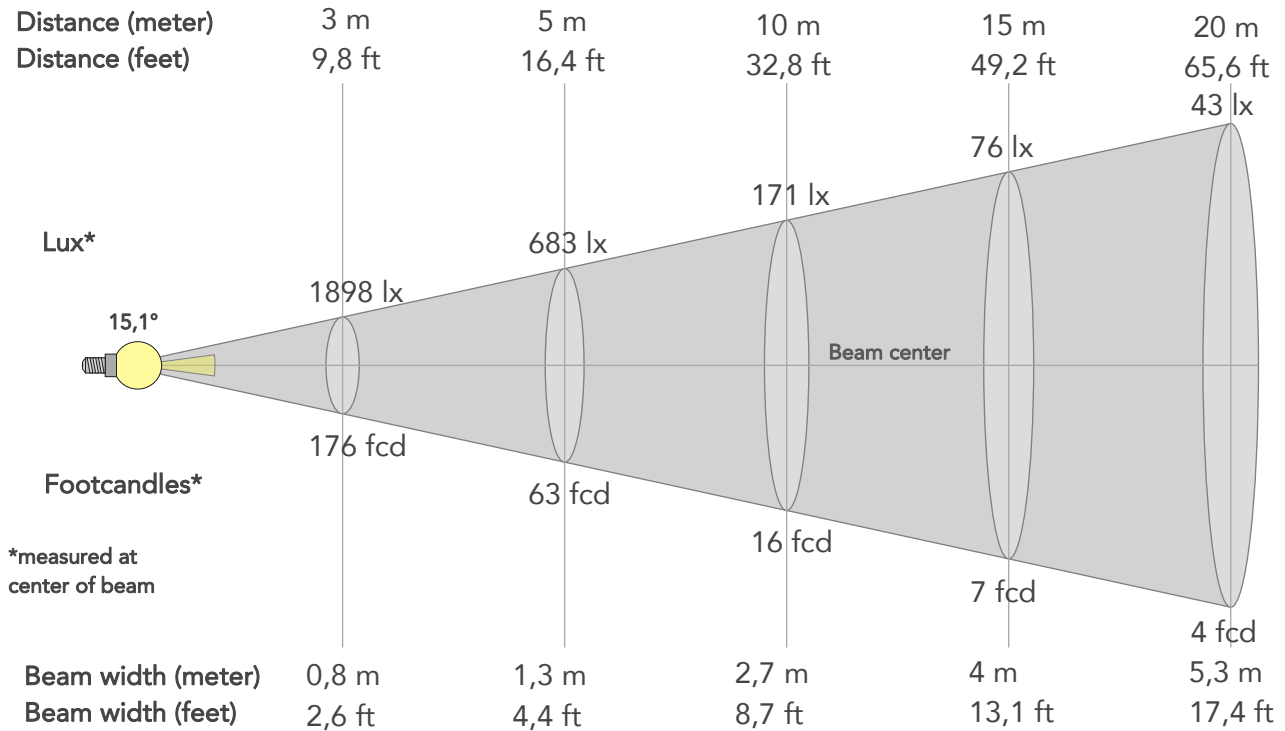

BEAM INTENSITIES AND WIDTHS

Distance	1m	2m	3m	4m	5m	7,5m	10m	15m	20m	25m	30m	40m	50m
Distance	3,3ft	6,6ft	9,8ft	13,1ft	16,4ft	24,6ft	32,8ft	49,2ft	65,6ft	82ft	98,4ft	131,2ft	164ft
Lux	17081lx	4270lx	1898lx	1068lx	683lx	304lx	171lx	76lx	43lx	27lx	19lx	11lx	7lx
Footcand.	1587fcd	397fcd	176fcd	99fcd	63fcd	28fcd	16fcd	7fcd	4fcd	3fcd	2fcd	1fcd	1fcd
Beam wid.	0,3m	0,5m	0,8m	1,1m	1,3m	2m	2,7m	4m	5,3m	6,6m	8m	10,6m	13,3m
Beam wid.	0,9ft	1,8ft	2,6ft	3,5ft	4,4ft	6,5ft	8,7ft	13,1ft	17,4ft	21,8ft	26,2ft	34,9ft	43,6ft

LINEAR DISTRIBUTION DIAGRAM

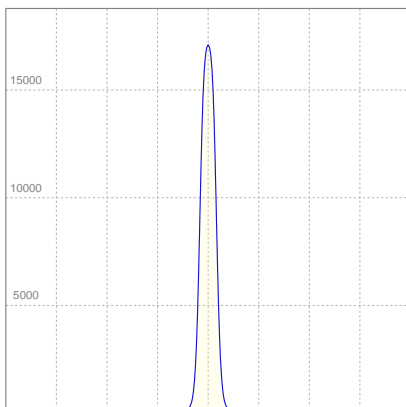

ELECTRICAL SPECIFICATIONS

Input voltage	Input current	Input power	Effeciency
222V	0,161A	33,6W	36lm/W
Power Fc			
0,94			

ISO CANDELA DIAGRAM

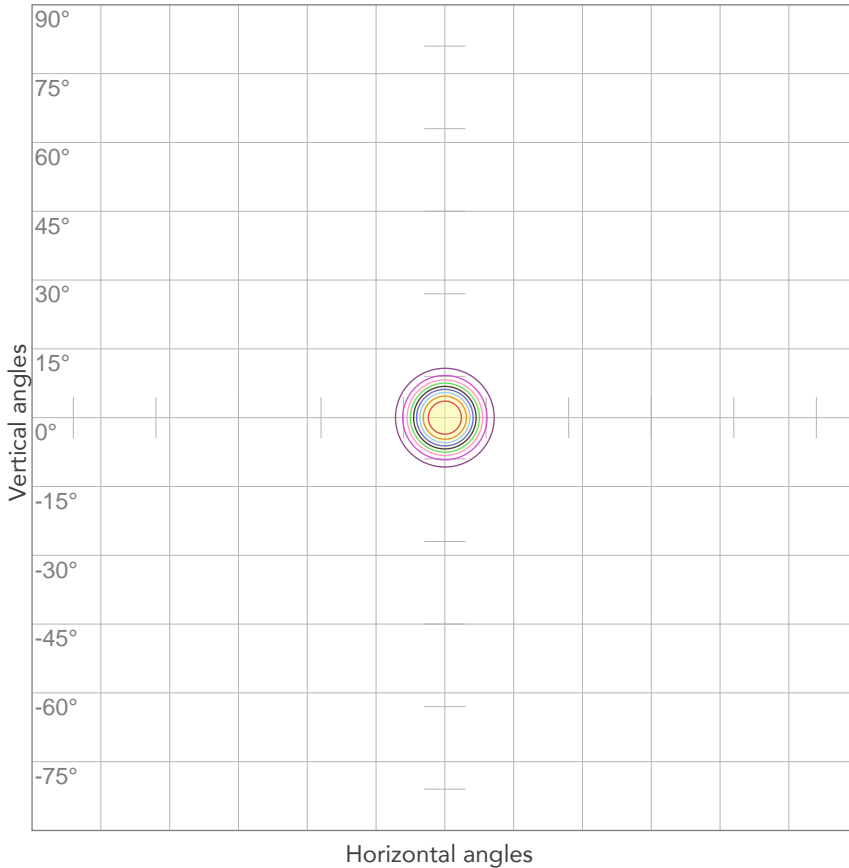

10%	1708 cd
20%	3416 cd
30%	5124 cd
40%	6832 cd
50%	8540 cd
60%	10248 cd
70%	11956 cd
80%	13664 cd

Conditions:
 Number of c-planes: 2
 Candela at center: 17081 cd

ISO LUX DIAGRAM

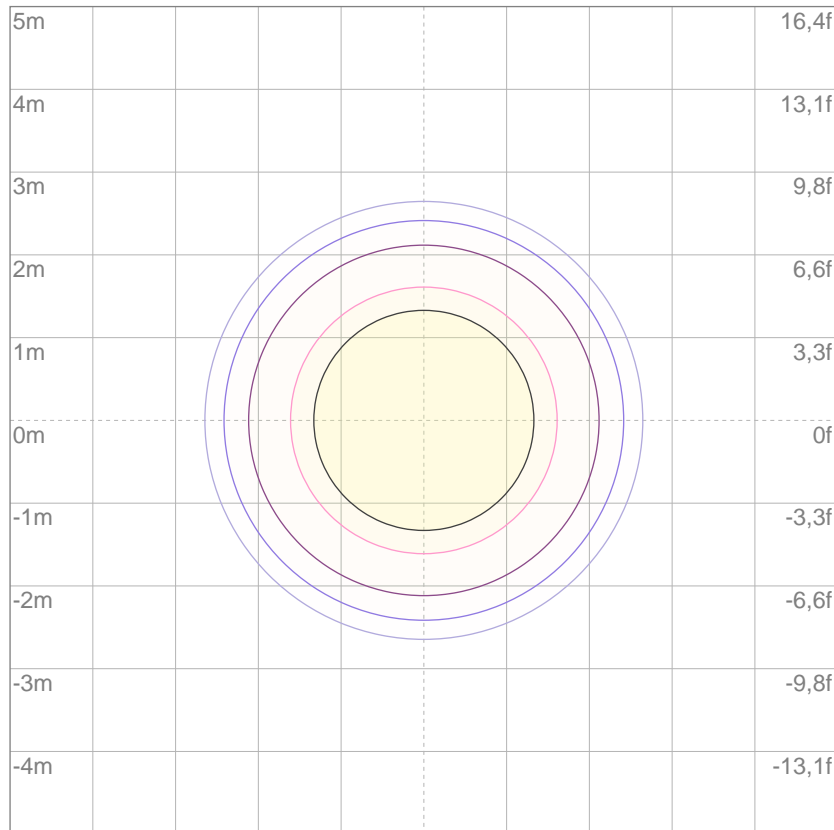

3%	5,12 lx
5%	8,54 lx
10%	17,1 lx
30%	51,2 lx
50%	85,4 lx

Conditions:
 Number of c-planes: 2
 Lux at center: 171 lx

Lux distribution on a surface when lamp is mounted at 10 meters from the surface.

Mounting height: 10 meters (33 feet)



Total lumen output:

1730 lm

Peak candela output:

6460 cd

Light quality:

CRI: 89,7

Color temperature:

3009 K

PRODUCT NAME:
ECLDISPLAY

MEASUREMENT CONDITIONS:

Beam angle:
Wash 15-30 Max Zoom

Target:
3000K

Operator:
Paolo Carvone

Date and time:
19/01/2021 16:56:47

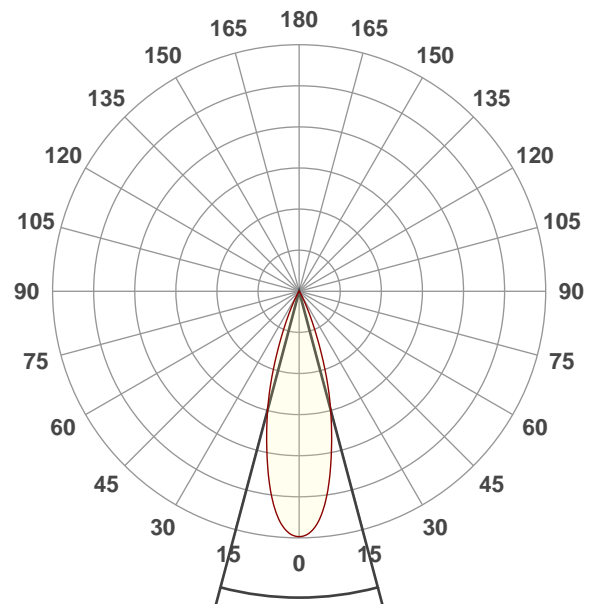

Beam angle 50%: 29,8°
Field angle 10%: 48,9°
Cut off angle 2.5%: 58,7°

Spectra

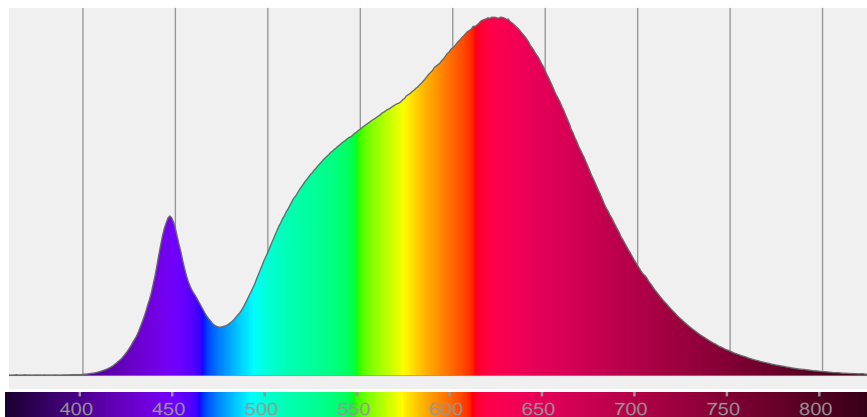

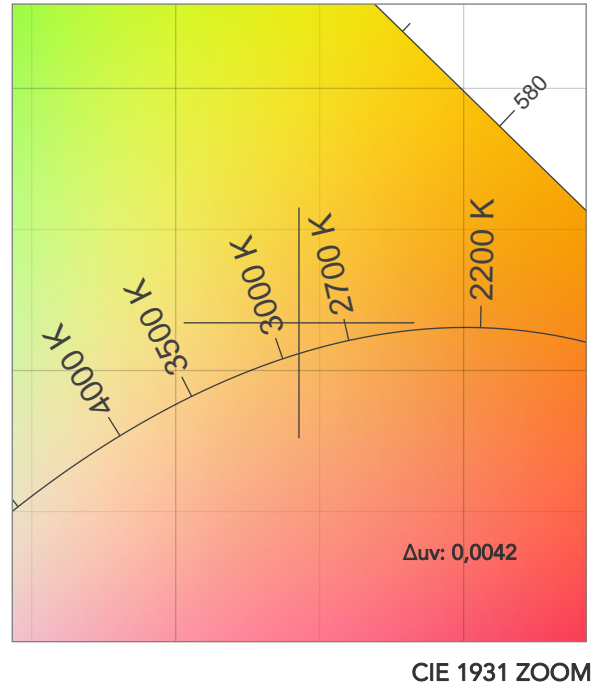
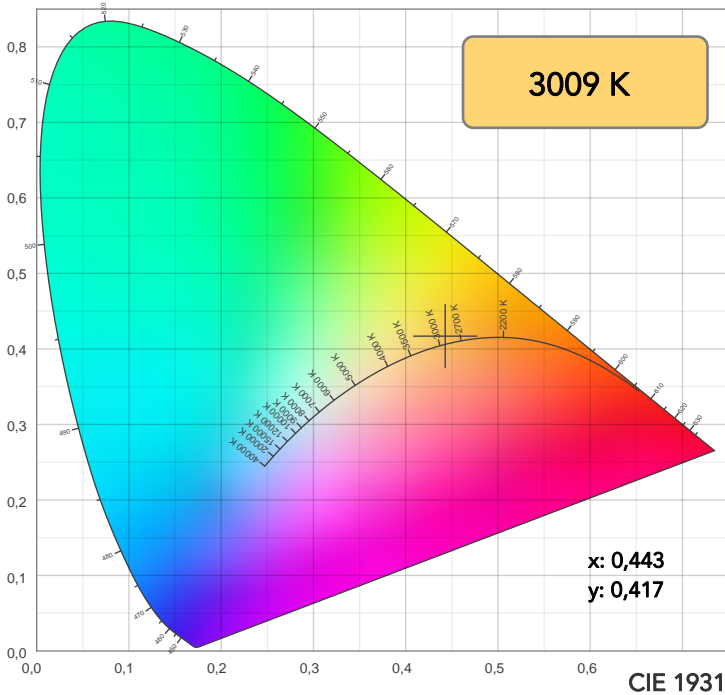

TM30: 89,2

CRI: 89,7 (R1-R8)

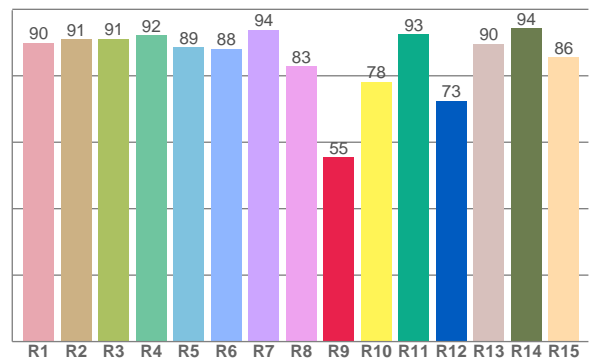
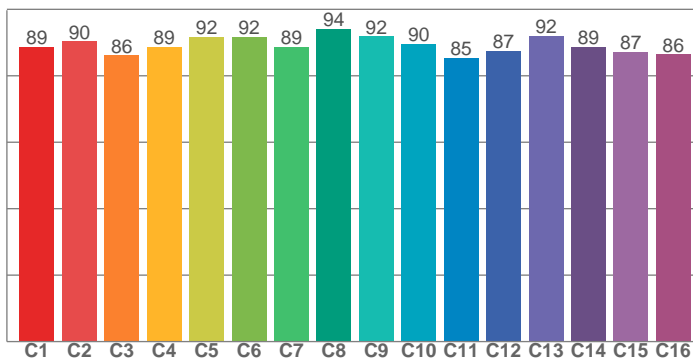

CRI R values, only R1-R8 are used to calculate final CRI value

R1	R2	R3	R4	R5	R6	R7	R8	R9	R10	R11	R12	R13	R14	R15
89,9	91,0	91,2	92,3	88,5	88,2	93,9	82,8	55,4	78,2	92,6	72,5	89,7	94,2	85,6

TM30 C values, 16 binned values out of total of 99 C values

C1	C2	C3	C4	C5	C6	C7	C8	C9	C10	C11	C12	C13	C14	C15	C16
88,7	90,3	86,1	88,6	91,7	91,7	88,6	94,2	91,8	89,5	85,3	87,4	92,0	88,6	87,2	86,4

CQS Q values

Q1	Q2	Q3	Q4	Q5	Q6	Q7	Q8	Q9	Q10	Q11	Q12	Q13	Q14	Q15
87,0	97,1	87,2	87,8	88,3	86,8	89,6	94,0	95,5	91,8	90,0	91,0	91,7	84,8	85,7

CQS: 89,2

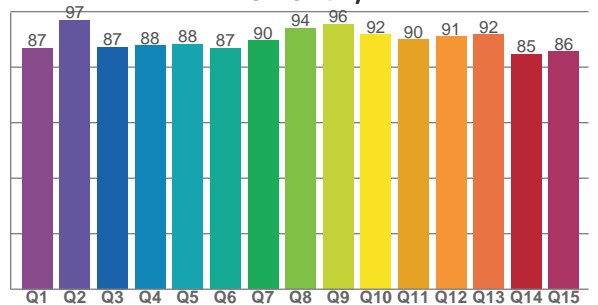

COLOR PARAMETERS

Color temperature	Color rendering index	Red component	Color fidelity	Color gamut	Color quality scale	Television lighting index	Color coordinate cie 1931	Color coordinate cie 1931	Color deviation from black body
CCT	CRI	CRI R9	TM30 Rf	TM30 Rg	CQS	TLCI	x	y	Δuv
3009 K	89,7	55,4	89,2	100,1	89,2	88	0,443	0,417	0,0042

TM30 DETAILS

Rf 89,2
Fidelity index Rf

Rg 100,1
Gammut index

Hue Bin	R _f	Graphic shifts (%)	
		Chroma	Hue
1	89	-5%	-2%
2	90	-4%	2%
3	86	-2%	6%
4	89	2%	6%
5	92	3%	5%
6	92	5%	0%
7	89	2%	-6%
8	94	0%	-3%
9	92	-4%	-2%
10	90	-5%	3%
11	85	-3%	9%
12	87	3%	5%
13	92	4%	-1%
14	89	5%	-6%
15	87	1%	-7%
16	86	-1%	-10%

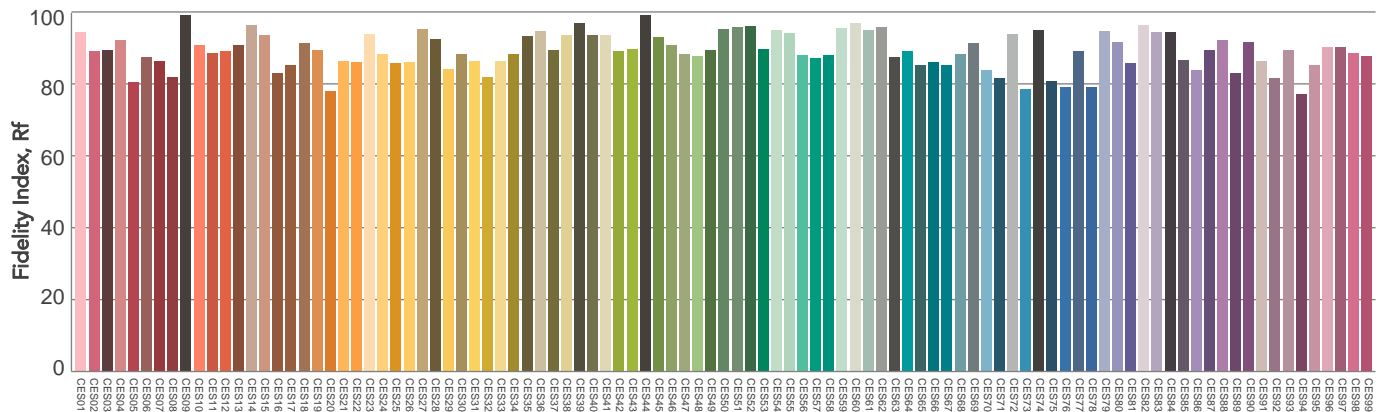
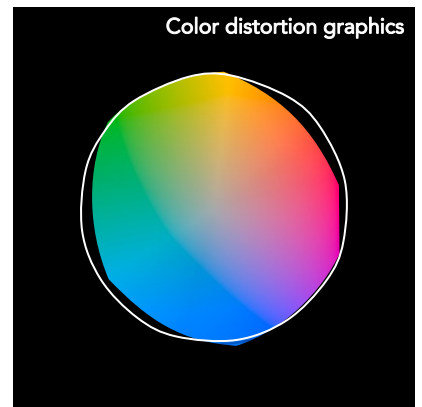
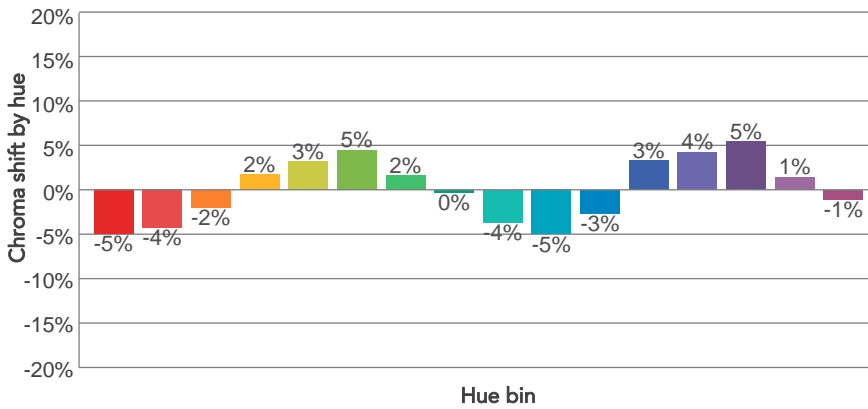
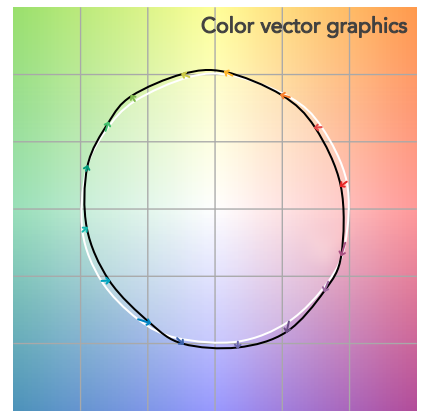
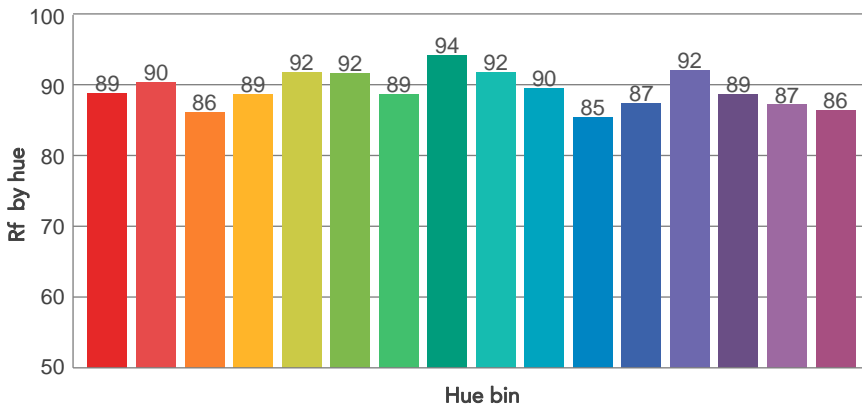
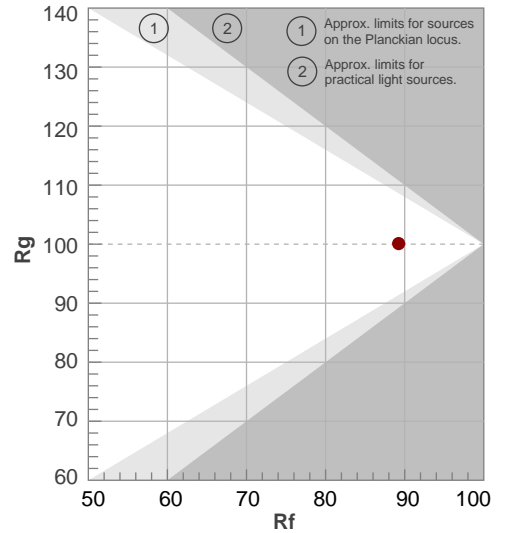

BEAM DETAILS



Beam angle 50%	Field angle 10%	Cut off angle 2,5%	Intensity ratio in 120° cone	Intensity ratio in 90° cone
29,8°	48,9°	58,7°	99,9%	99,4%

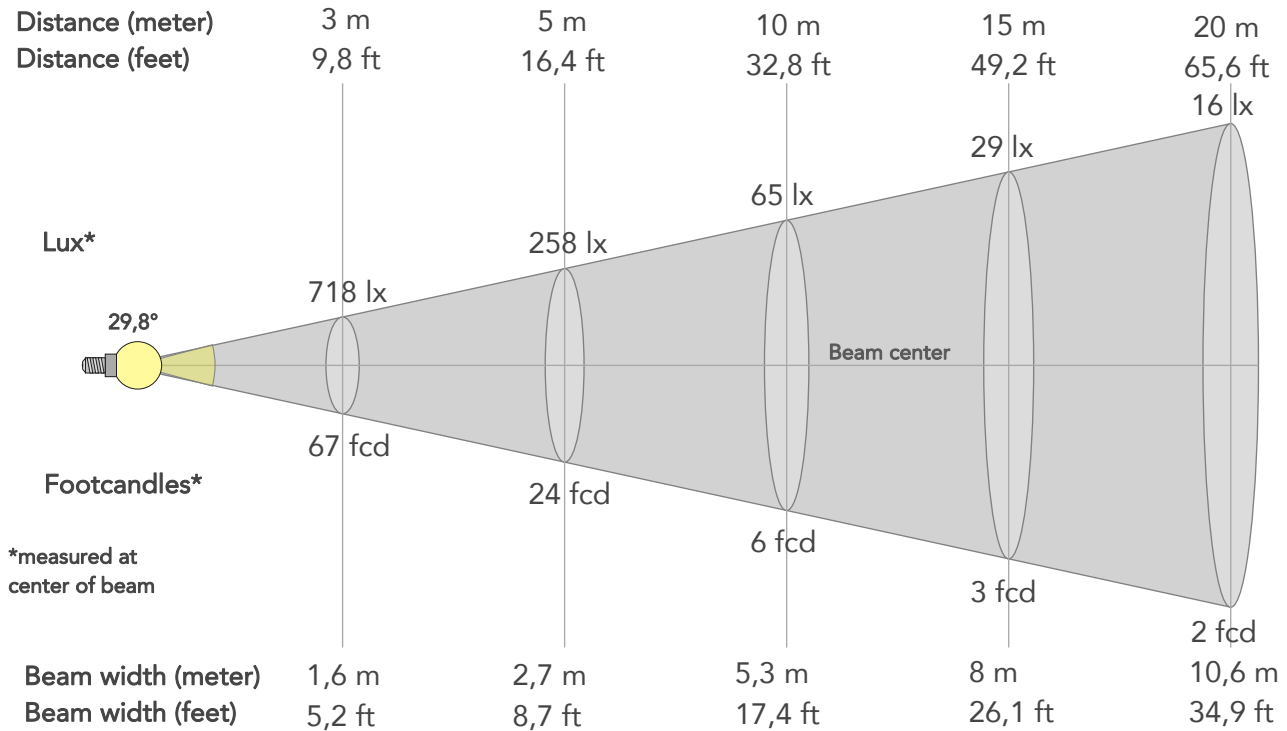

BEAM INTENSITIES AND WIDTHS

Distance	1m	2m	3m	4m	5m	7,5m	10m	15m	20m	25m	30m	40m	50m
Distance	3,3ft	6,6ft	9,8ft	13,1ft	16,4ft	24,6ft	32,8ft	49,2ft	65,6ft	82ft	98,4ft	131,2ft	164ft
Lux	6460lx	1615lx	718lx	404lx	258lx	115lx	65lx	29lx	16lx	10lx	7lx	4lx	3lx
Footcand.	600fcd	150fcd	67fcd	38fcd	24fcd	11fcd	6fcd	3fcd	2fcd	1fcd	1fcd	0fcd	0fcd
Beam wid.	0,5m	1,1m	1,6m	2,1m	2,7m	4m	5,3m	8m	10,6m	13,3m	15,9m	21,3m	26,6m
Beam wid.	1,8ft	3,5ft	5,2ft	7ft	8,7ft	13,1ft	17,4ft	26,1ft	34,9ft	43,6ft	52,3ft	69,7ft	87,2ft

LINEAR DISTRIBUTION DIAGRAM

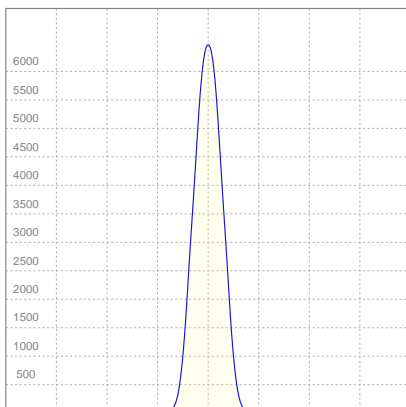

ELECTRICAL SPECIFICATIONS

Input voltage	Input current	Input power	Effeciency
224V	0,161A	33,8W	51lm/W
Power Fc			
0,94			

ISO CANDELA DIAGRAM

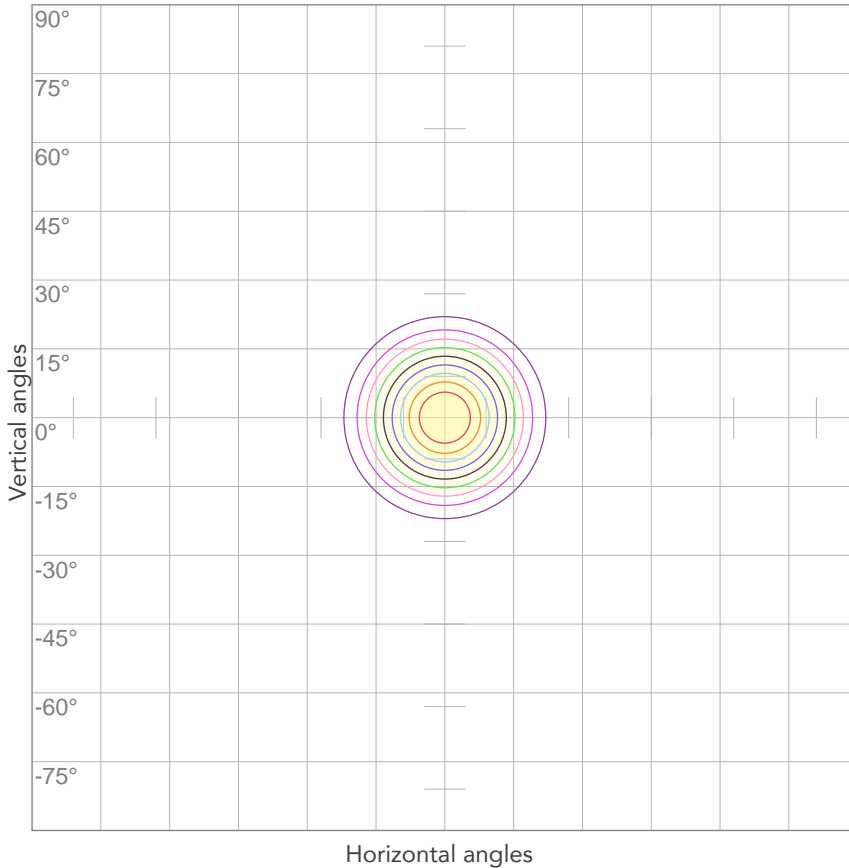

10%	646 cd
20%	1292 cd
30%	1938 cd
40%	2584 cd
50%	3230 cd
60%	3876 cd
70%	4522 cd
80%	5168 cd

Conditions:

Number of c-planes: 2

Candela at center: 6460 cd

ISO LUX DIAGRAM

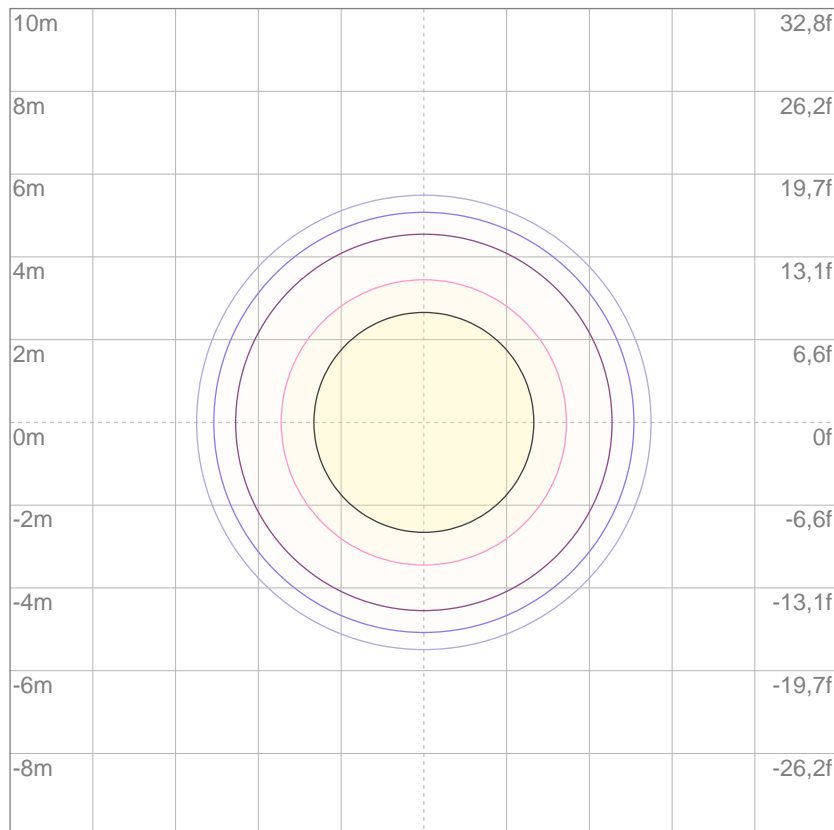

3%	1,94 lx
5%	3,23 lx
10%	6,46 lx
30%	19,4 lx
50%	32,3 lx

Conditions:

Number of c-planes: 2

Lux at center: 64,6 lx

Lux distribution on a surface when lamp is mounted at 10 meters from the surface.

Mounting height: 10 meters (33 feet)



Total lumen output:

1350 lm

Peak candela output:

19486 cd

Light quality:

CRI: 89,7

Color temperature:

2991 K

PRODUCT NAME:
ECLDISPLAY

MEASURAMENT CONDITIONS:

Beam angle:
Wash 15-30 Min Zoom

Target:
3000K

Operator:
Paolo Carvone

Date and time:
19/01/2021 16:55:03

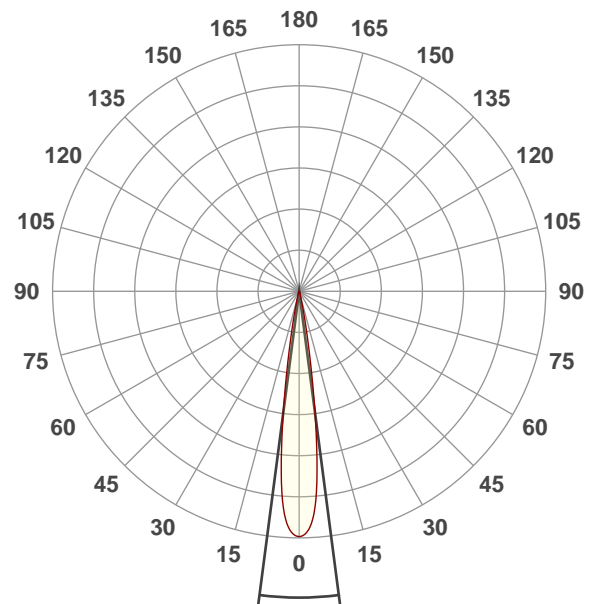

Beam angle 50%: 14,9°
Field angle 10%: 23,5°
Cut off angle 2.5%: 30,2°

Spectra

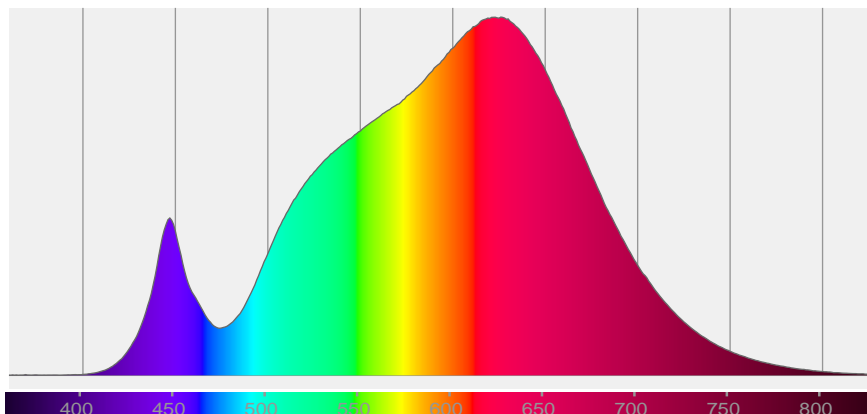

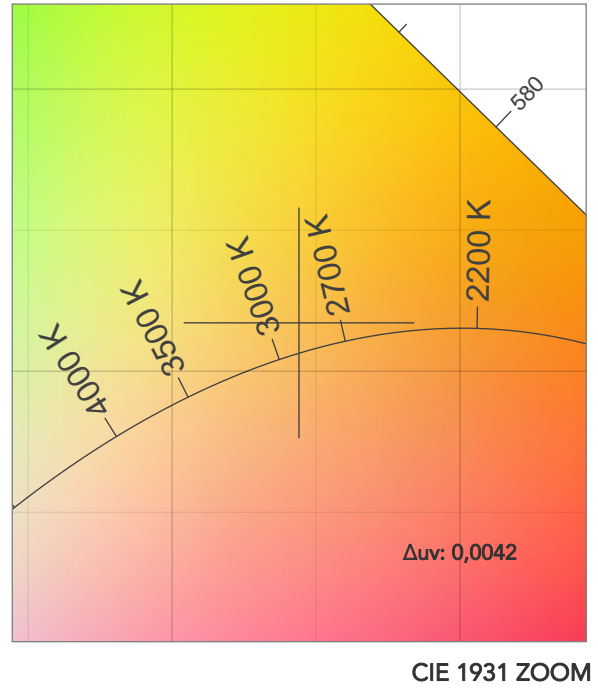
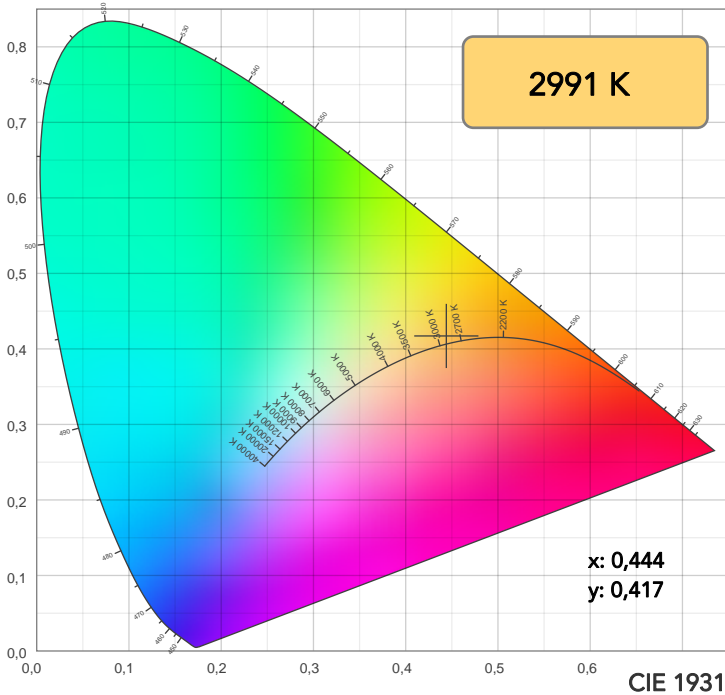

TM30: 89,1

CRI: 89,7 (R1-R8)

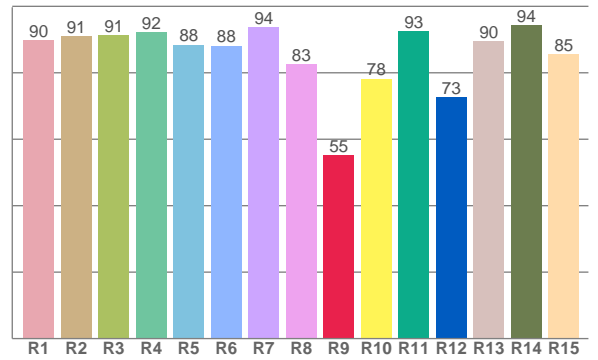
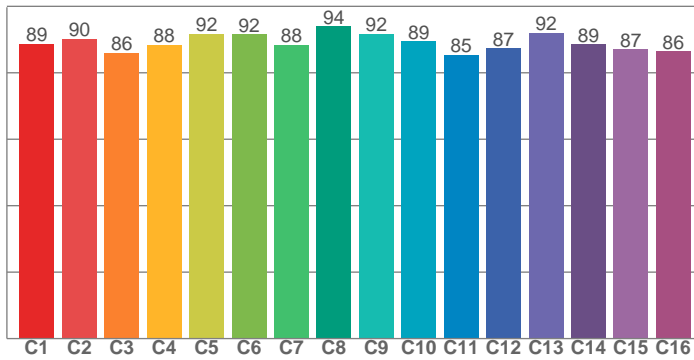

CRI R values, only R1-R8 are used to calculate final CRI value

R1	R2	R3	R4	R5	R6	R7	R8	R9	R10	R11	R12	R13	R14	R15
89,9	91,0	91,2	92,2	88,5	88,2	93,8	82,6	55,2	78,2	92,5	72,6	89,6	94,3	85,5

TM30 C values, 16 binned values out of total of 99 C values

C1	C2	C3	C4	C5	C6	C7	C8	C9	C10	C11	C12	C13	C14	C15	C16
88,7	90,2	85,9	88,5	91,6	91,5	88,4	94,0	91,7	89,5	85,3	87,4	92,0	88,6	87,0	86,4

CQS Q values

Q1	Q2	Q3	Q4	Q5	Q6	Q7	Q8	Q9	Q10	Q11	Q12	Q13	Q14	Q15
86,8	97,0	87,2	87,7	88,1	86,6	89,4	93,9	95,5	91,8	89,9	90,9	91,6	84,6	85,5

CQS: 89,1

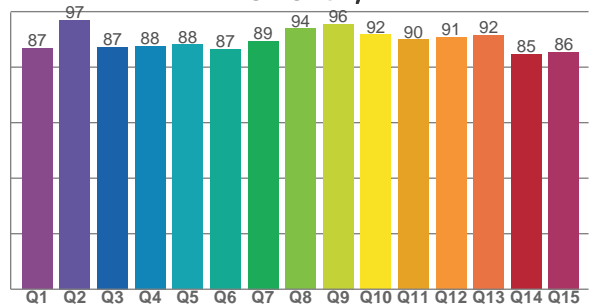

COLOR PARAMETERS

Color temperature	Color rendering index	Red component	Color fidelity	Color gamut	Color quality scale	Television lighting index	Color coordinate cie 1931	Color coordinate cie 1931	Color deviation from black body
CCT	CRI	CRI R9	TM30 Rf	TM30 Rg	CQS	TLCI	x	y	Δuv
2991 K	89,7	55,2	89,1	100,1	89,1	88	0,444	0,417	0,0042

TM30 DETAILS

Rf 89,1
Fidelity index Rf

Rg 100,1
Gammut index

Hue Bin	R _f	Graphic shifts (%)	
		Chroma	Hue
1	89	-5%	-2%
2	90	-4%	2%
3	86	-2%	6%
4	88	2%	6%
5	92	3%	5%
6	92	5%	0%
7	88	2%	-6%
8	94	0%	-4%
9	92	-4%	-2%
10	89	-5%	3%
11	85	-3%	9%
12	87	3%	5%
13	92	4%	-1%
14	89	5%	-6%
15	87	1%	-7%
16	86	-1%	-9%

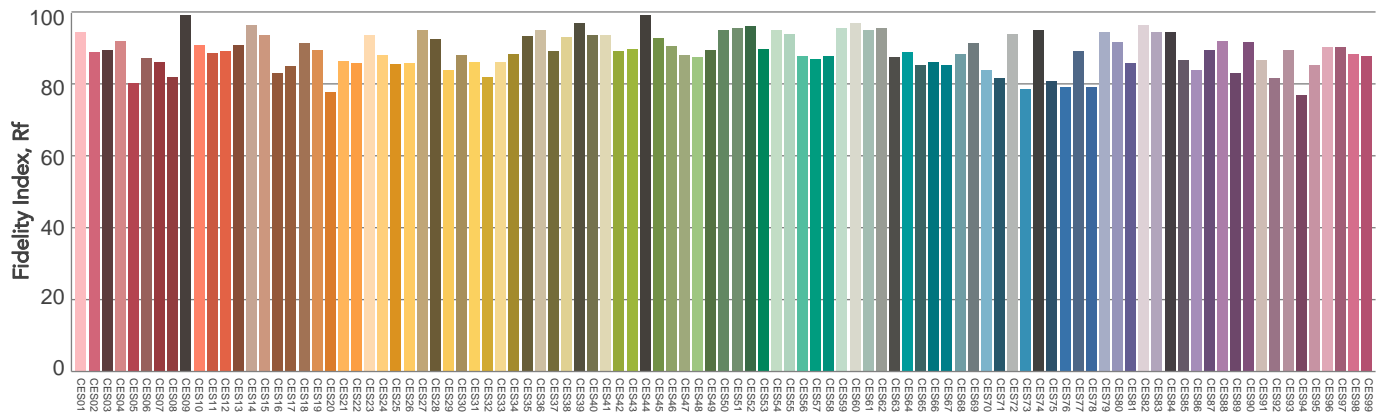
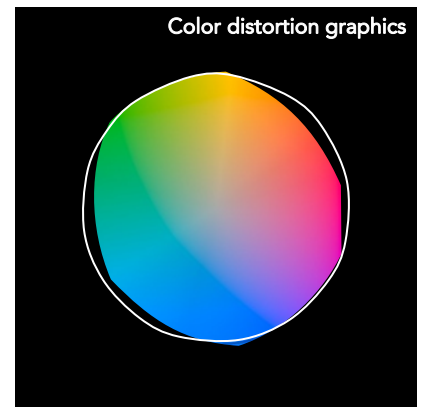
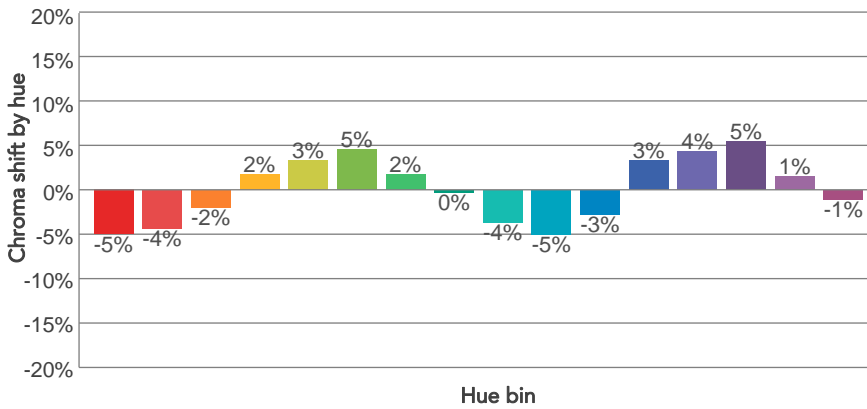
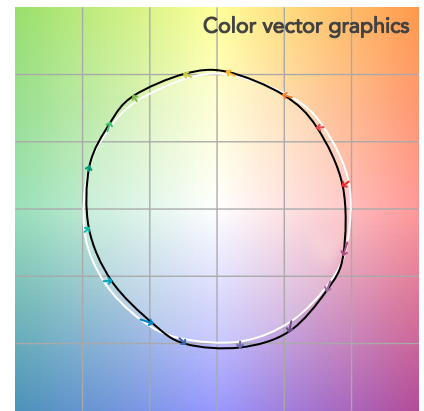
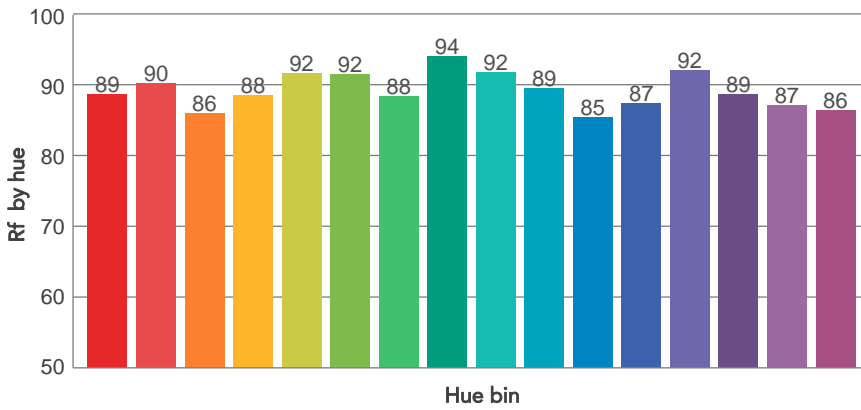
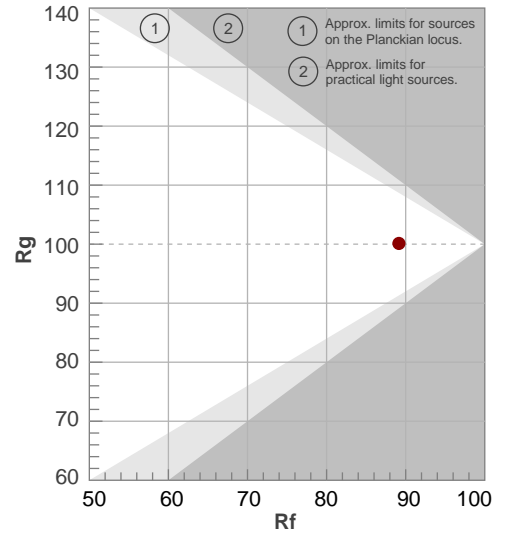

BEAM DETAILS



Beam angle 50%	Field angle 10%	Cut off angle 2,5%	Intensity ratio in 120° cone	Intensity ratio in 90° cone
14,9°	23,5°	30,2°	100,0%	100,0%

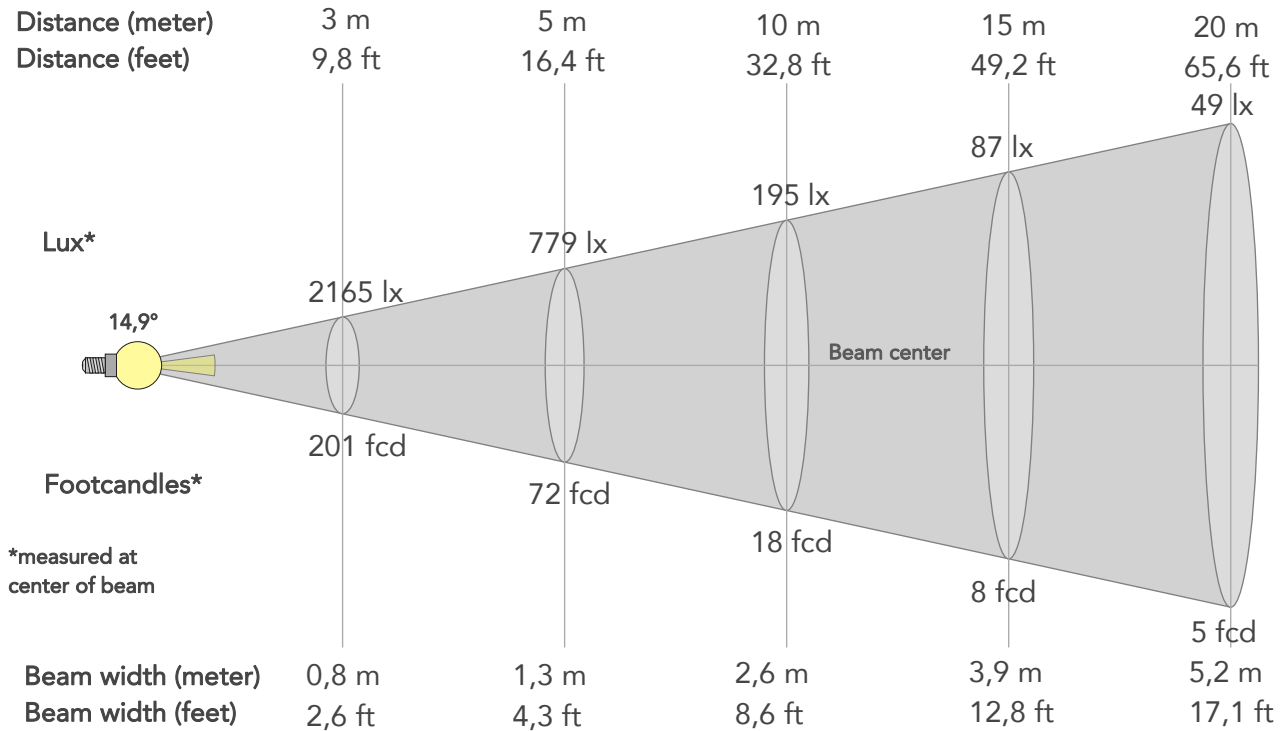

BEAM INTENSITIES AND WIDTHS

Distance	1m	2m	3m	4m	5m	7,5m	10m	15m	20m	25m	30m	40m	50m
Distance	3,3ft	6,6ft	9,8ft	13,1ft	16,4ft	24,6ft	32,8ft	49,2ft	65,6ft	82ft	98,4ft	131,2ft	164ft
Lux	19486lx	4872lx	2165lx	1218lx	779lx	346lx	195lx	87lx	49lx	31lx	22lx	12lx	8lx
Footcand.	1810fcd	453fcd	201fcd	113fcd	72fcd	32fcd	18fcd	8fcd	5fcd	3fcd	2fcd	1fcd	1fcd
Beam wid.	0,3m	0,5m	0,8m	1m	1,3m	2m	2,6m	3,9m	5,2m	6,5m	7,8m	10,4m	13,1m
Beam wid.	0,9ft	1,7ft	2,6ft	3,4ft	4,3ft	6,4ft	8,6ft	12,8ft	17,1ft	21,4ft	25,7ft	34,3ft	42,8ft

LINEAR DISTRIBUTION DIAGRAM

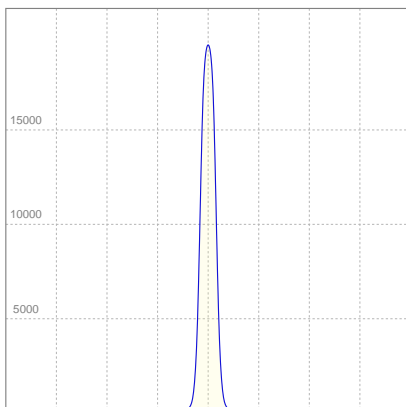

ELECTRICAL SPECIFICATIONS

Input voltage	Input current	Input power	Effeciency
222V	0,162A	33,8W	40lm/W
Power Fc			
0,94			

ISO CANDELA DIAGRAM

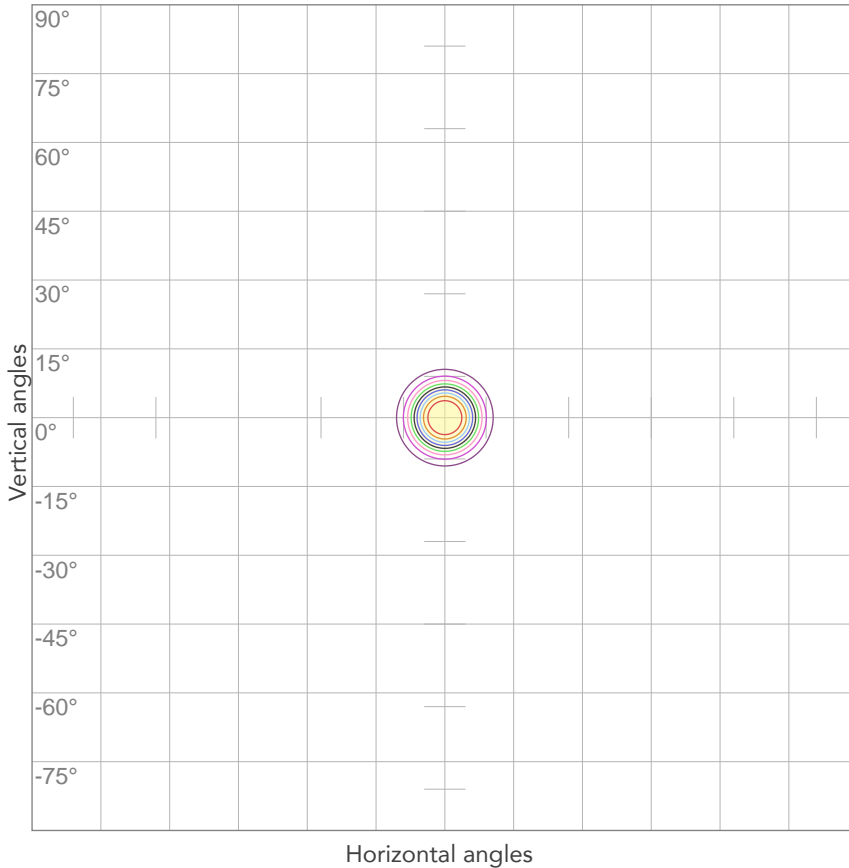

10%	1949 cd
20%	3897 cd
30%	5846 cd
40%	7794 cd
50%	9743 cd
60%	11692 cd
70%	13640 cd
80%	15589 cd

Conditions:

Number of c-planes: 2

Candela at center: 19486 cd

ISO LUX DIAGRAM

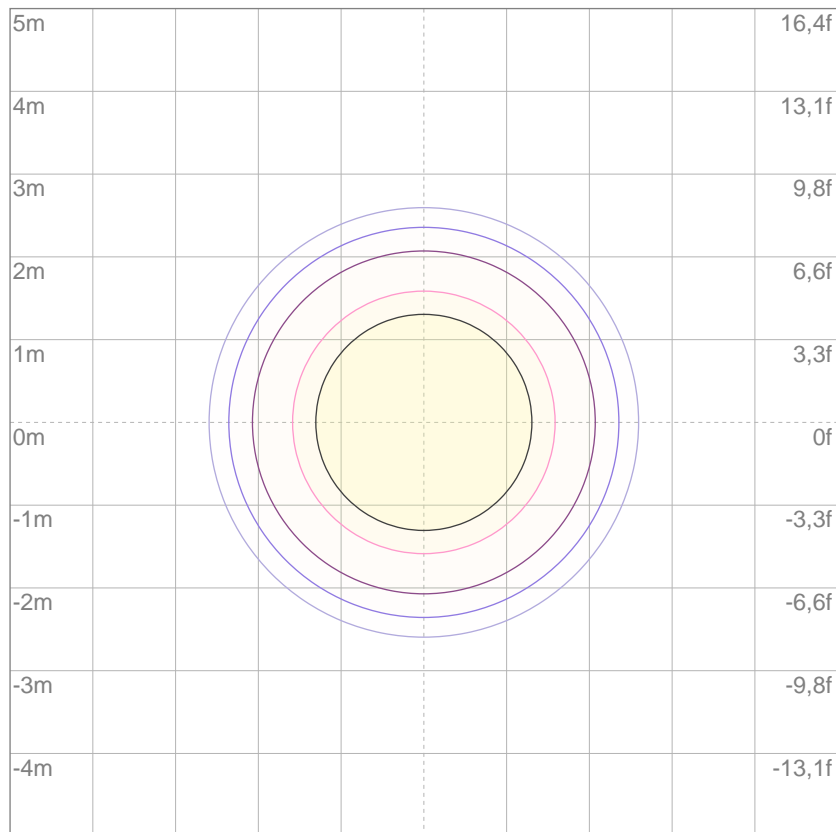

3%	5,85 lx
5%	9,74 lx
10%	19,5 lx
30%	58,5 lx
50%	97,4 lx

Conditions:

Number of c-planes: 2

Lux at center: 195 lx

Lux distribution on a surface when lamp is mounted at 10 meters from the surface.

Mounting height: 10 meters (33 feet)



Total lumen output:

1724 lm

Peak candela output:

6413 cd

Light quality:

CRI: 93,5

Color temperature:

3959 K

PRODUCT NAME:

ECLDISPLAY

MEASUREMENT CONDITIONS:

Beam angle:

Wash 15-30 Max Zoom

Target:

4000K

Operator:

Paolo Carvone

Date and time:

19/01/2021 17:42:41

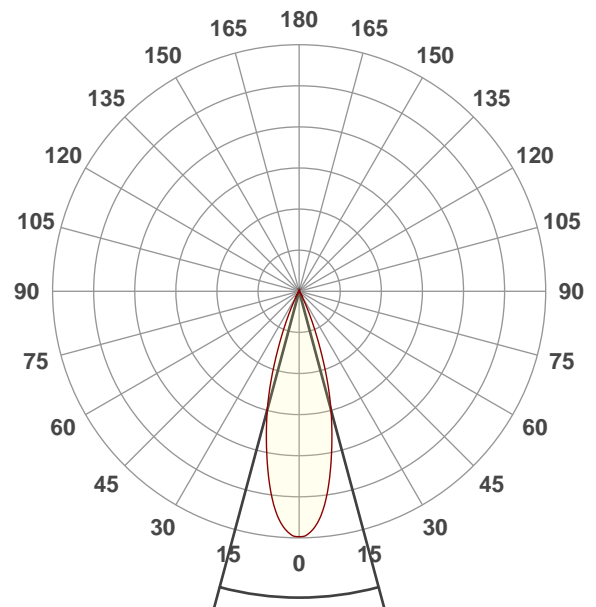

Beam angle 50%: 30,1°

Field angle 10%: 48,7°

Cut off angle 2.5%: 58,2°

Spectra

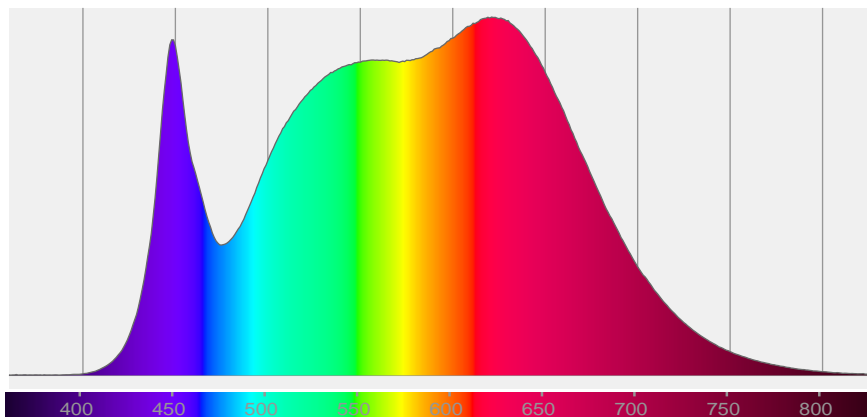

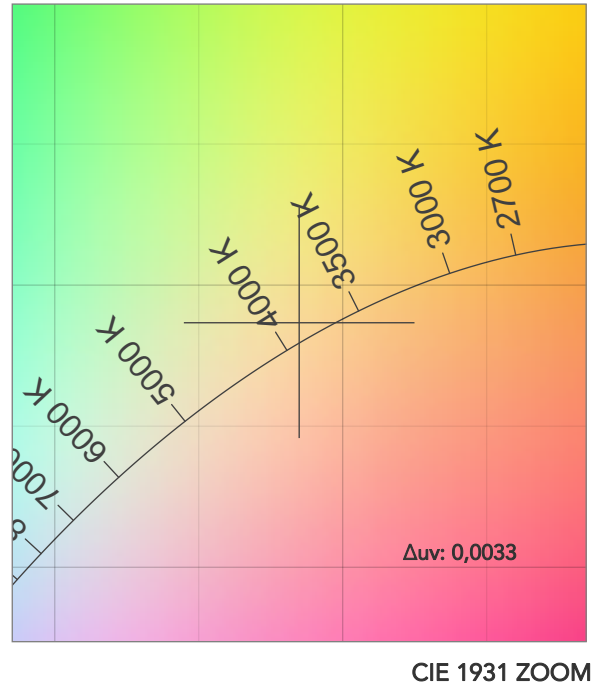
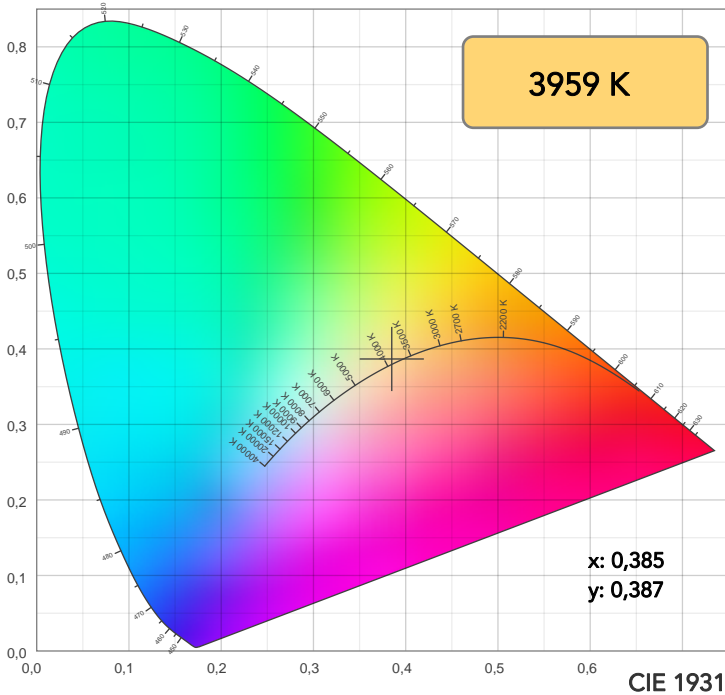

TM30: 92,0

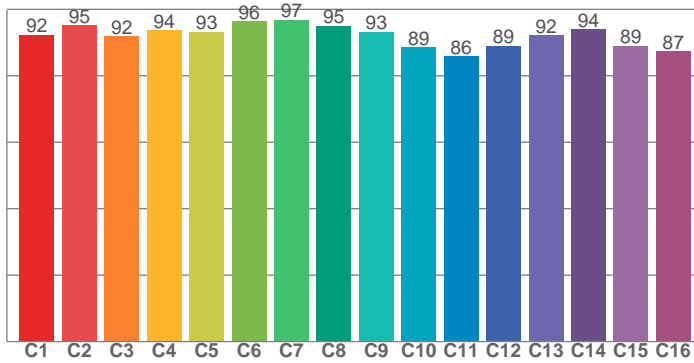

CRI: 93,5 (R1-R8)

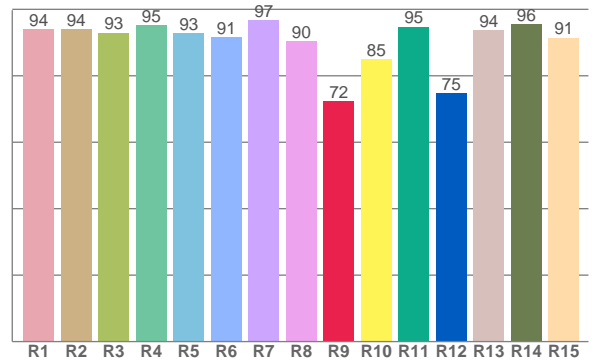

CRI R values, only R1-R8 are used to calculate final CRI value

R1	R2	R3	R4	R5	R6	R7	R8	R9	R10	R11	R12	R13	R14	R15
94,0	94,0	93,0	95,2	92,8	91,5	96,6	90,5	72,2	85,0	94,8	74,8	93,8	95,6	91,5

TM30 C values, 16 binned values out of total of 99 C values

C1	C2	C3	C4	C5	C6	C7	C8	C9	C10	C11	C12	C13	C14	C15	C16
92,3	95,1	91,9	93,7	93,2	96,4	96,8	95,0	93,2	88,6	85,8	88,9	92,2	94,0	89,0	87,3

CQS Q values

Q1	Q2	Q3	Q4	Q5	Q6	Q7	Q8	Q9	Q10	Q11	Q12	Q13	Q14	Q15
93,9	99,1	88,8	89,8	93,4	93,8	94,4	97,1	97,6	95,1	95,5	96,2	96,6	92,2	92,9

CQS: 93,8

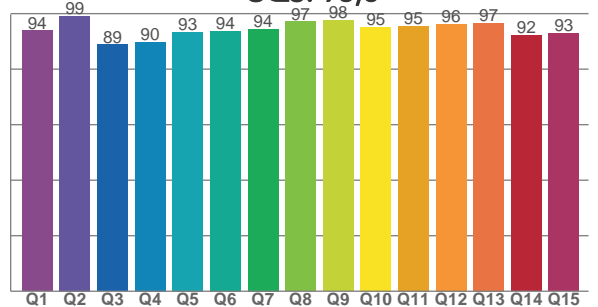

COLOR PARAMETERS

Color temperature	Color rendering index	Red component	Color fidelity	Color gamut	Color quality scale	Television lighting index	Color coordinate cie 1931	Color coordinate cie 1931	Color deviation from black body
CCT	CRI	CRI R9	TM30 Rf	TM30 Rg	CQS	TLCI	x	y	Δuv
3959 K	93,5	72,2	92,0	99,7	93,8	95	0,385	0,387	0,0033

TM30 DETAILS

Rf 92,0
Fidelity index Rf

Rg 99,7
Gammut index

Hue Bin	R _f	Graphic shifts (%)	
		Chroma	Hue
1	92	-3%	-1%
2	95	-2%	1%
3	92	-2%	3%
4	94	-1%	2%
5	93	-1%	2%
6	96	1%	0%
7	97	-1%	-1%
8	95	-2%	0%
9	93	-3%	3%
10	89	-3%	6%
11	86	2%	8%
12	89	3%	4%
13	92	4%	-2%
14	94	4%	-1%
15	89	2%	-7%
16	87	0%	-7%

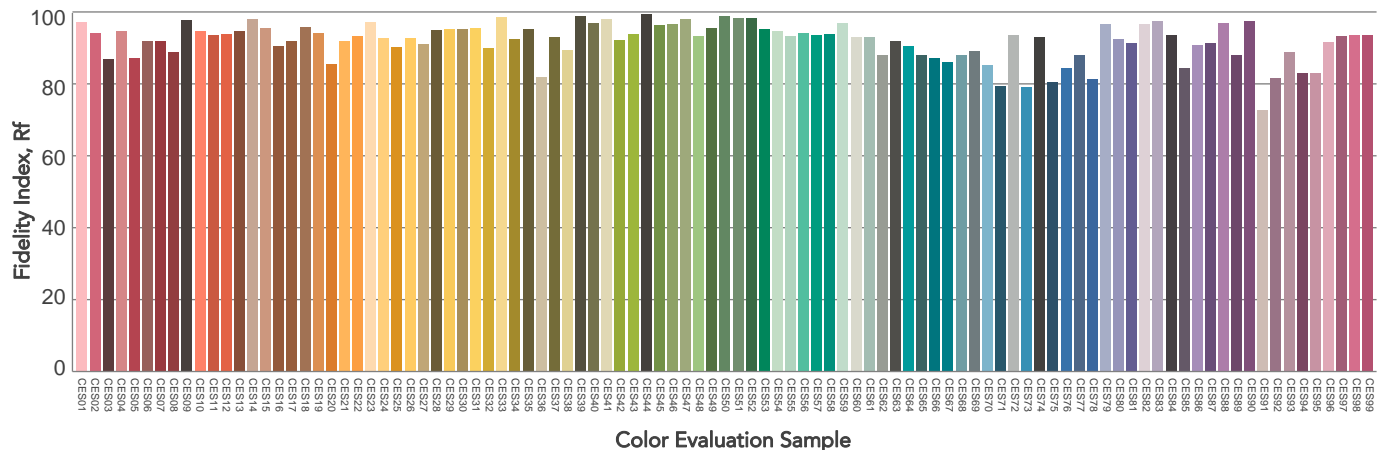
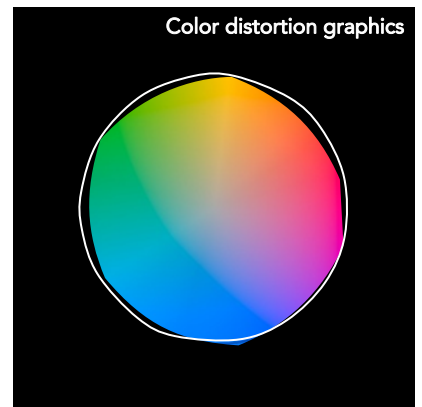
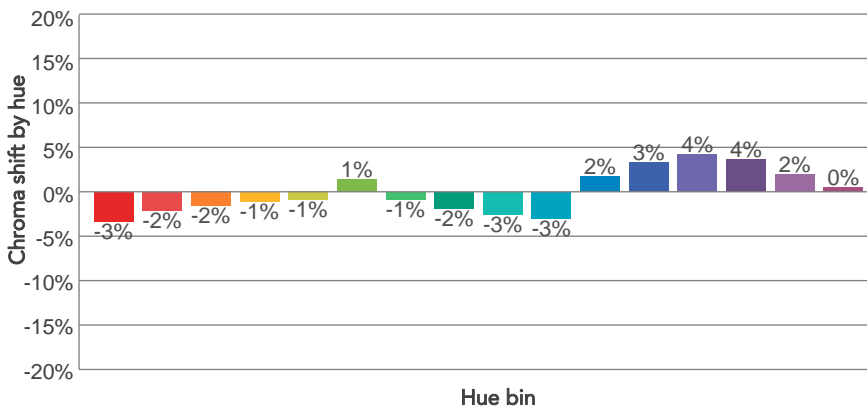
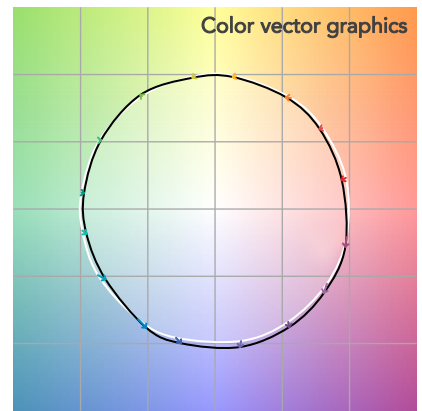
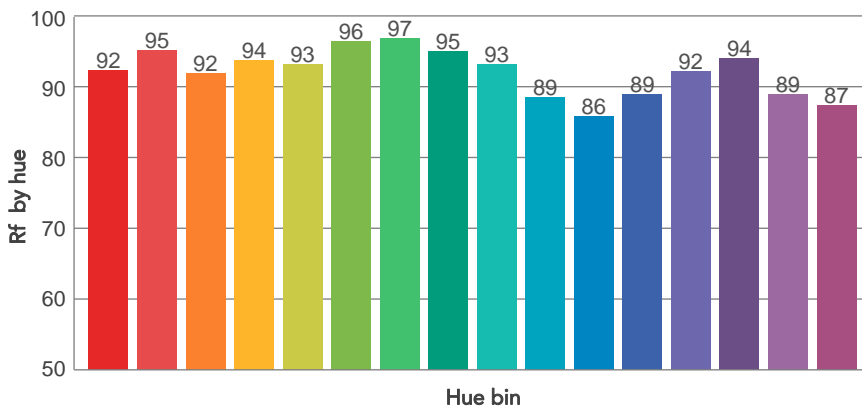
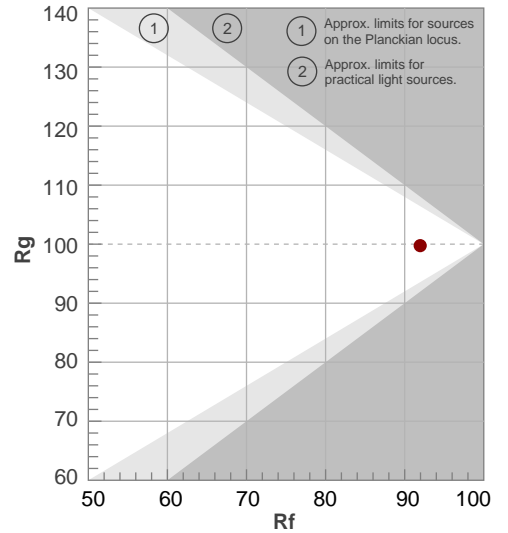

BEAM DETAILS



Beam angle 50%	Field angle 10%	Cut off angle 2,5%	Intensity ratio in 120° cone	Intensity ratio in 90° cone
30,1°	48,7°	58,2°	99,9%	99,4%

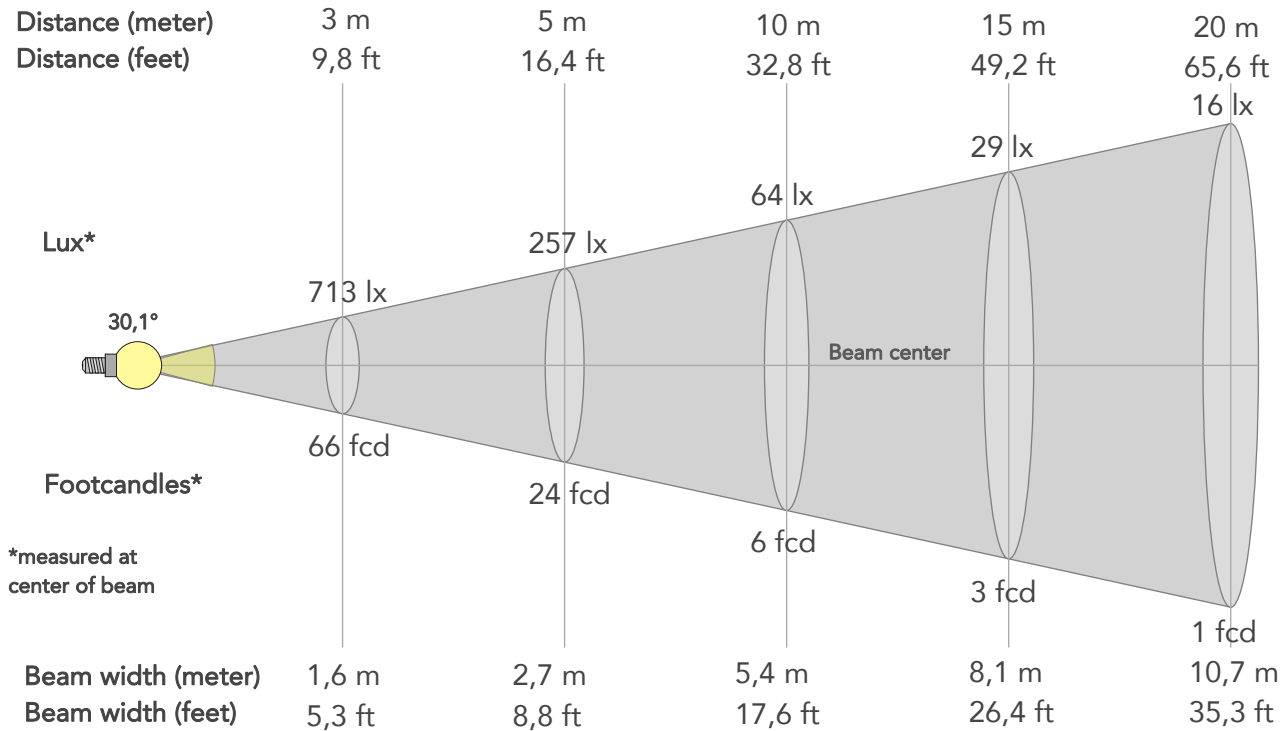

BEAM INTENSITIES AND WIDTHS

Distance	1m	2m	3m	4m	5m	7,5m	10m	15m	20m	25m	30m	40m	50m
Distance	3,3ft	6,6ft	9,8ft	13,1ft	16,4ft	24,6ft	32,8ft	49,2ft	65,6ft	82ft	98,4ft	131,2ft	164ft
Lux	6413lx	1603lx	713lx	401lx	257lx	114lx	64lx	29lx	16lx	10lx	7lx	4lx	3lx
Footcand.	596fcd	149fcd	66fcd	37fcd	24fcd	11fcd	6fcd	3fcd	1fcd	1fcd	1fcd	0fcd	0fcd
Beam wid.	0,5m	1,1m	1,6m	2,1m	2,7m	4m	5,4m	8,1m	10,7m	13,4m	16,1m	21,5m	26,9m
Beam wid.	1,8ft	3,5ft	5,3ft	7ft	8,8ft	13,2ft	17,6ft	26,4ft	35,3ft	44,1ft	52,9ft	70,5ft	88,1ft

LINEAR DISTRIBUTION DIAGRAM

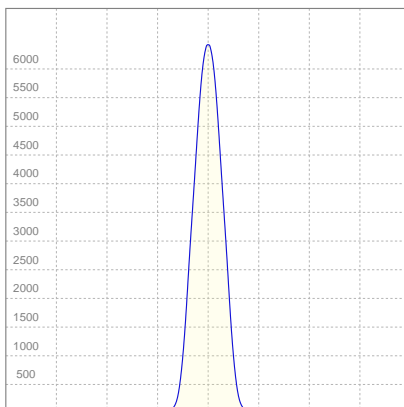

ELECTRICAL SPECIFICATIONS

Input voltage	Input current	Input power	Effeciency
223V	0,161A	33,6W	51lm/W
Power Fc			
0,94			

ISO CANDELA DIAGRAM

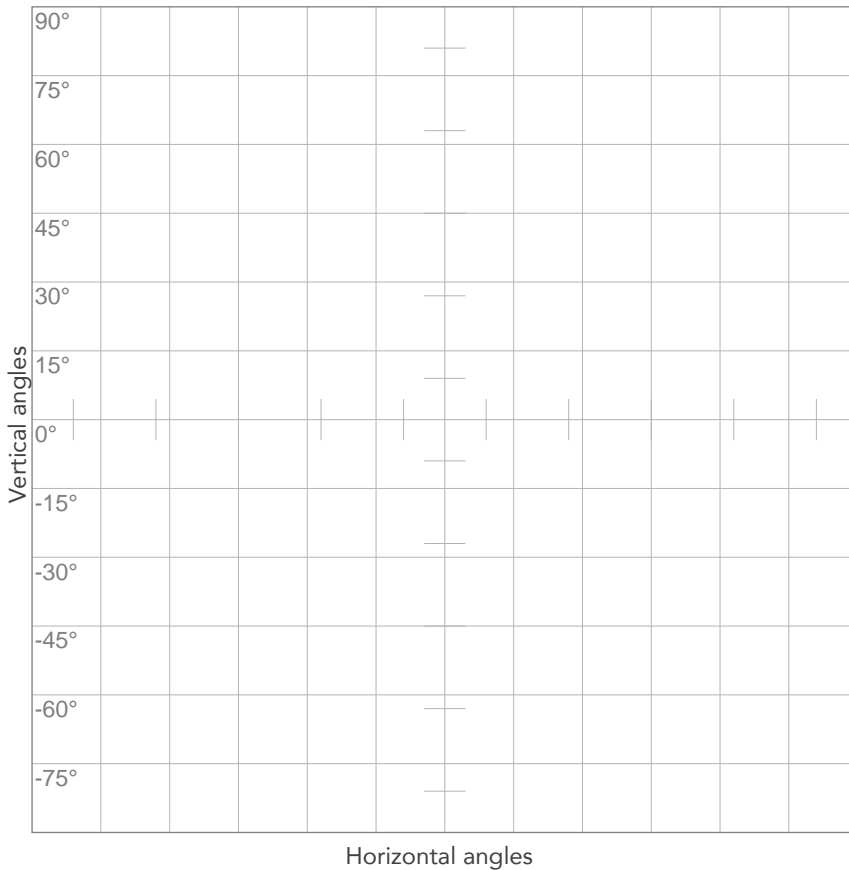

10%	641 cd
20%	1283 cd
30%	1924 cd
40%	2565 cd
50%	3207 cd
60%	3848 cd
70%	4489 cd
80%	5131 cd

Conditions:
 Number of c-planes: 2
 Candela at center: 6413 cd

ISO LUX DIAGRAM

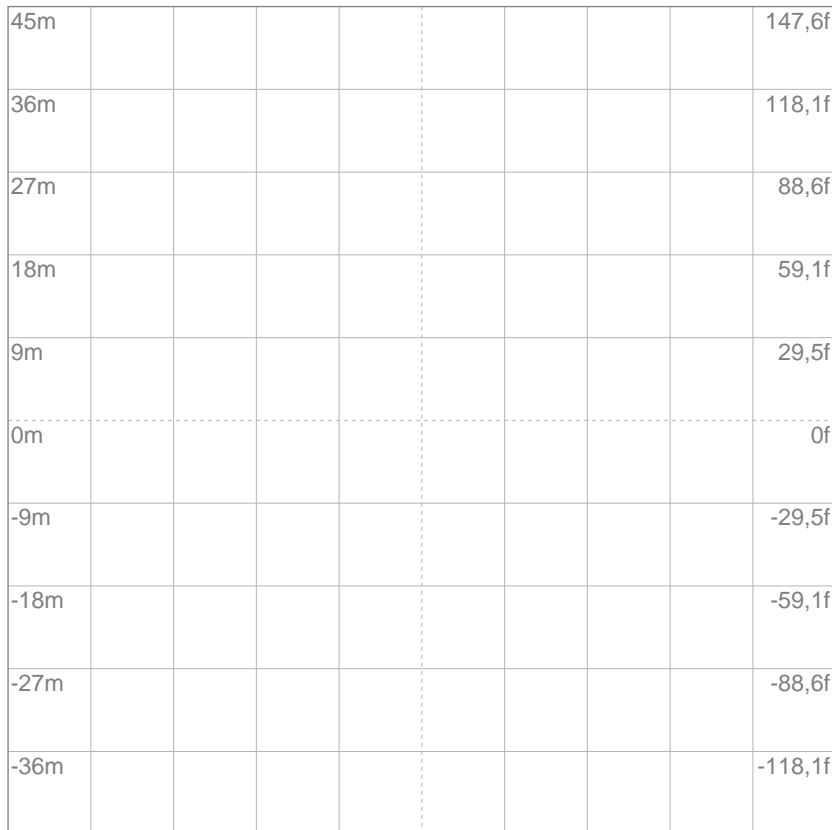

3%	1,92 lx
5%	3,21 lx
10%	6,41 lx
30%	19,2 lx
50%	32,1 lx

Conditions:
 Number of c-planes: 2
 Lux at center: 64,1 lx

Lux distribution on a surface when lamp is mounted at 10 meters from the surface.

Mounting height: 10 meters (33 feet)



Total lumen output:

1333 lm

Peak candela output:

18909 cd

Light quality:

CRI: 93,6

Color temperature:

3921 K

PRODUCT NAME:
ECLDISPLAY

MEASURAMENT CONDITIONS:

Beam angle:
Wash 15-30 Min Zoom

Target:
4000K

Operator:
Paolo Carvone

Date and time:
19/01/2021 17:44:29

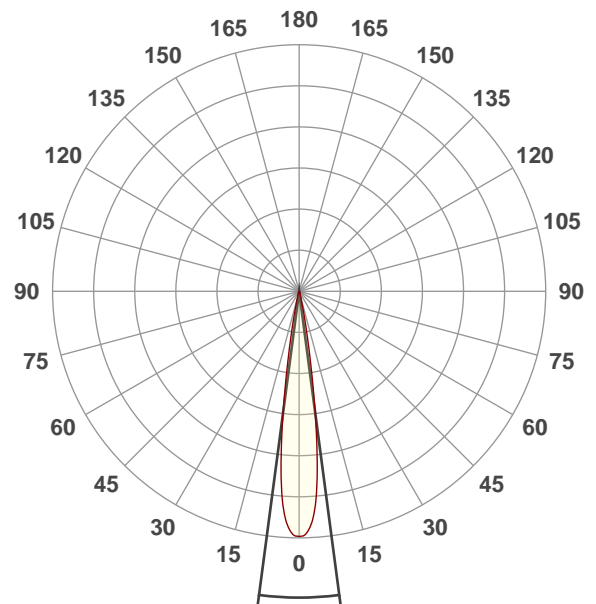

Beam angle 50%: 15,1°
Field angle 10%: 23,6°
Cut off angle 2.5%: 30,5°

Spectra

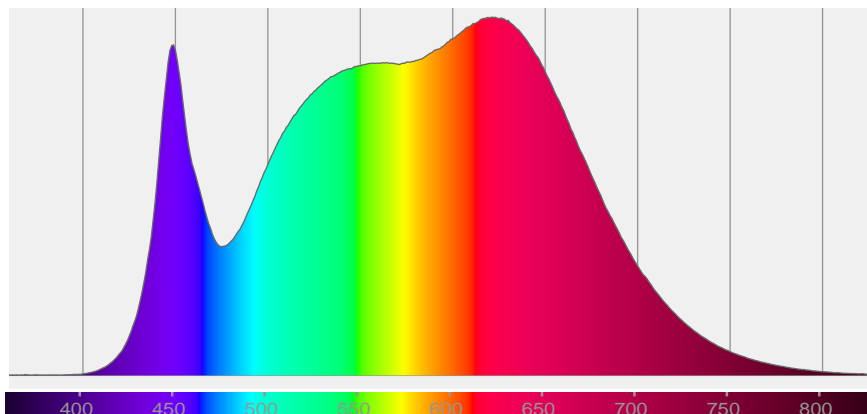

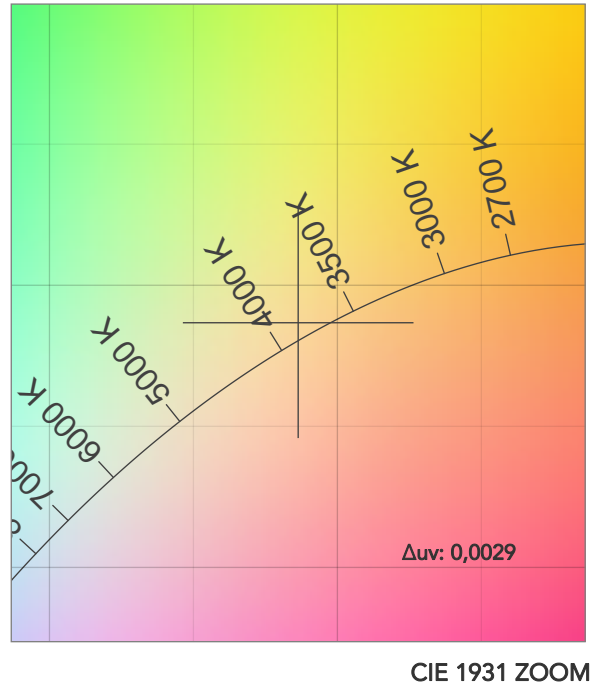
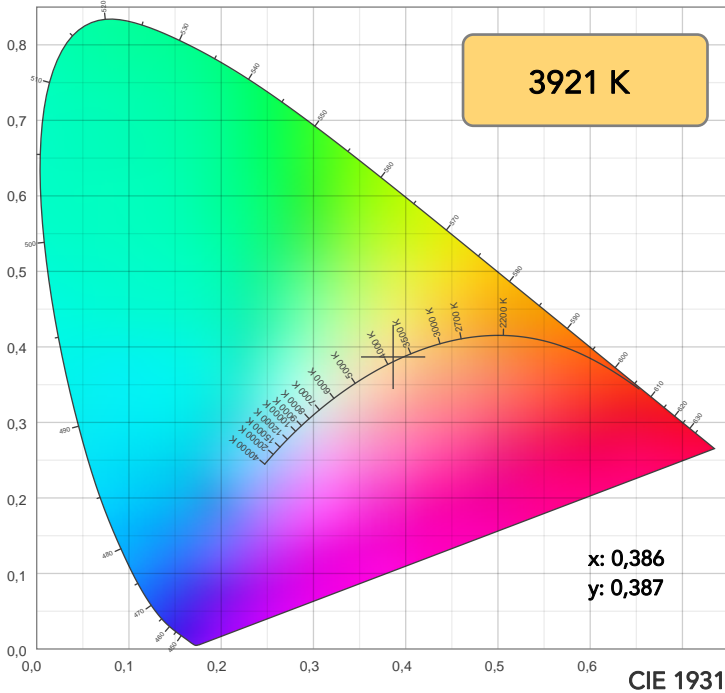

TM30: 92,0

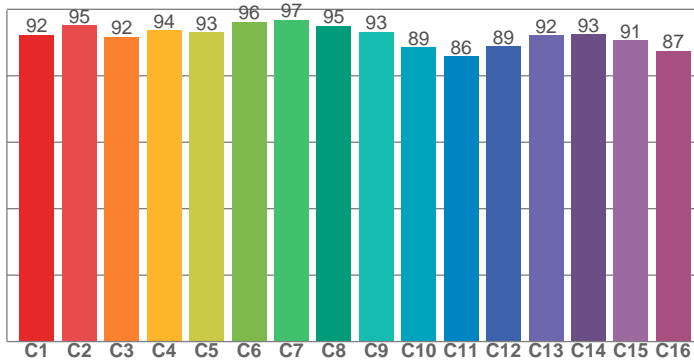

CRI: 93,6 (R1-R8)

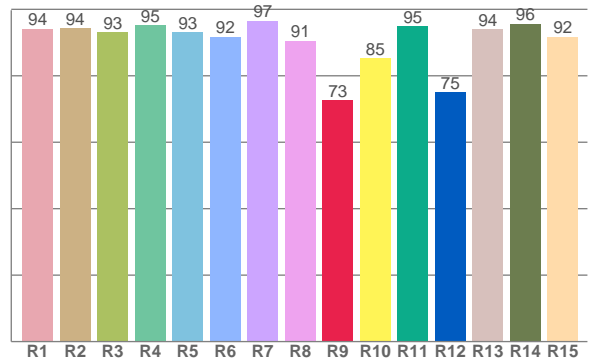

CQS: 93,8

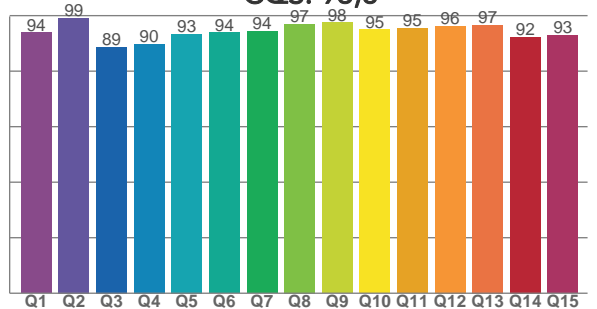

CRI R values, only R1-R8 are used to calculate final CRI value

R1	R2	R3	R4	R5	R6	R7	R8	R9	R10	R11	R12	R13	R14	R15
94,2	94,2	93,1	95,2	93,0	91,7	96,6	90,5	72,6	85,4	94,9	75,1	94,0	95,6	91,7

TM30 C values, 16 binned values out of total of 99 C values

C1	C2	C3	C4	C5	C6	C7	C8	C9	C10	C11	C12	C13	C14	C15	C16
92,4	95,1	91,8	93,7	93,1	96,3	96,9	95,0	93,3	88,6	85,8	88,9	92,2	92,5	90,6	87,4

CQS Q values

Q1	Q2	Q3	Q4	Q5	Q6	Q7	Q8	Q9	Q10	Q11	Q12	Q13	Q14	Q15
94,0	99,1	88,7	89,7	93,4	93,9	94,3	97,0	97,6	95,0	95,4	96,2	96,7	92,3	92,9

COLOR PARAMETERS

Color temperature	Color rendering index	Red component	Color fidelity	Color gamut	Color quality scale	Television lighting index	Color coordinate cie 1931	Color coordinate cie 1931	Color deviation from black body
CCT	CRI	CRI R9	TM30 Rf	TM30 Rg	CQS	TLCI	x	y	Δuv
3921 K	93,6	72,6	92,0	99,9	93,8	95	0,386	0,387	0,0029

TM30 DETAILS

Rf 92,0
Fidelity index Rf

Rg 99,9
Gammut index

Hue Bin	R _f	Graphic shifts (%)	
		Chroma	Hue
1	92	-3%	-1%
2	95	-2%	1%
3	92	-2%	3%
4	94	-1%	2%
5	93	-1%	2%
6	96	2%	0%
7	97	-1%	-1%
8	95	-2%	0%
9	93	-2%	3%
10	89	-3%	6%
11	86	2%	8%
12	89	3%	4%
13	92	4%	-2%
14	93	6%	-2%
15	91	2%	-5%
16	87	0%	-7%

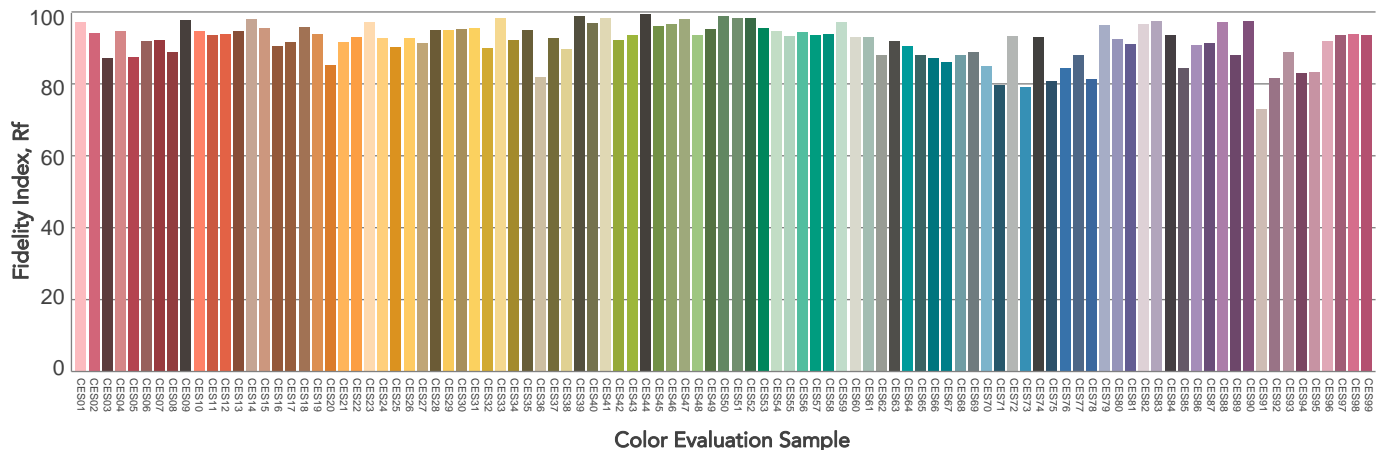
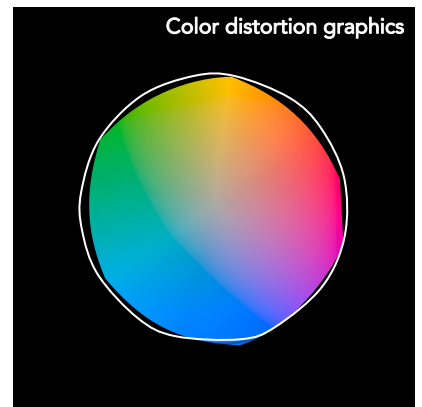
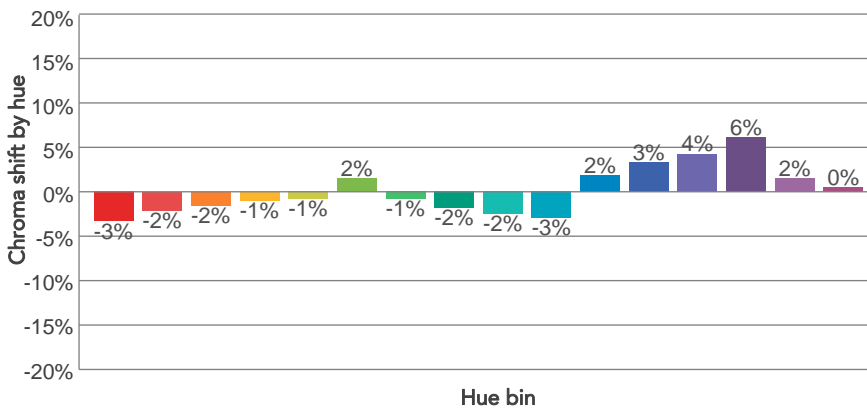
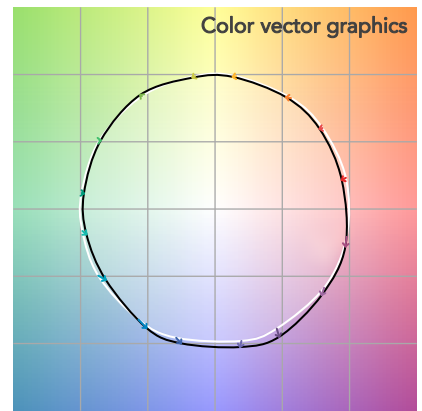
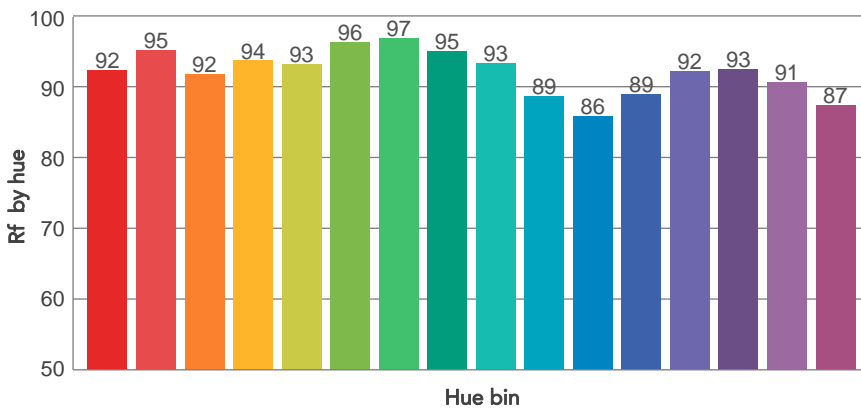
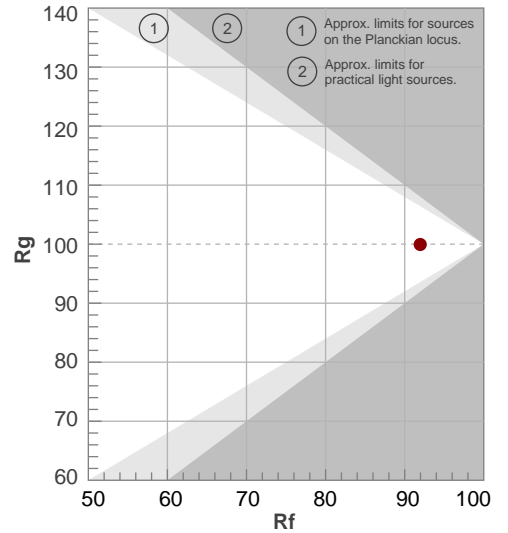

BEAM DETAILS



Beam angle 50%	Field angle 10%	Cut off angle 2,5%	Intensity ratio in 120° cone	Intensity ratio in 90° cone
15,1°	23,6°	30,5°	100,0%	100,0%

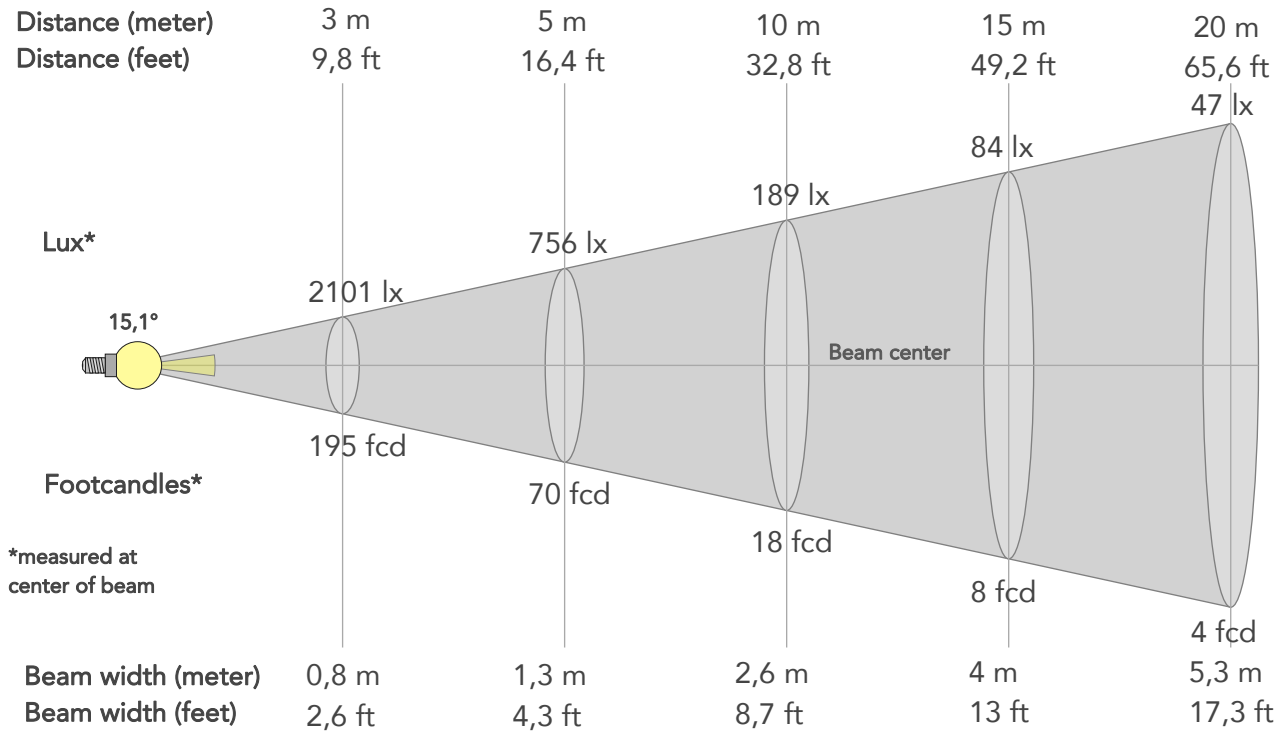

BEAM INTENSITIES AND WIDTHS

Distance	1m	2m	3m	4m	5m	7,5m	10m	15m	20m	25m	30m	40m	50m
Distance	3,3ft	6,6ft	9,8ft	13,1ft	16,4ft	24,6ft	32,8ft	49,2ft	65,6ft	82ft	98,4ft	131,2ft	164ft
Lux	18909lx	4727lx	2101lx	1182lx	756lx	336lx	189lx	84lx	47lx	30lx	21lx	12lx	8lx
Footcand.	1757fcd	439fcd	195fcd	110fcd	70fcd	31fcd	18fcd	8fcd	4fcd	3fcd	2fcd	1fcd	1fcd
Beam wid.	0,3m	0,5m	0,8m	1,1m	1,3m	2m	2,6m	4m	5,3m	6,6m	7,9m	10,6m	13,2m
Beam wid.	0,9ft	1,7ft	2,6ft	3,5ft	4,3ft	6,5ft	8,7ft	13ft	17,3ft	21,7ft	26ft	34,7ft	43,3ft

LINEAR DISTRIBUTION DIAGRAM

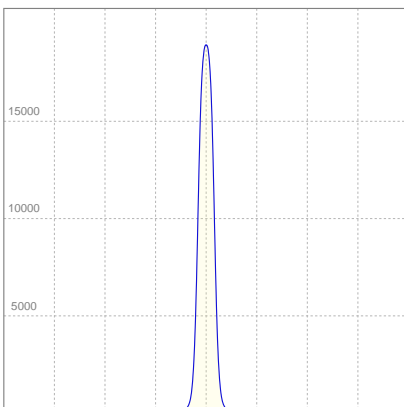

ELECTRICAL SPECIFICATIONS

Input voltage	Input current	Input power	Effeciency
222V	0,161A	33,6W	40lm/W

Power Fc
0,94

ISO CANDELA DIAGRAM

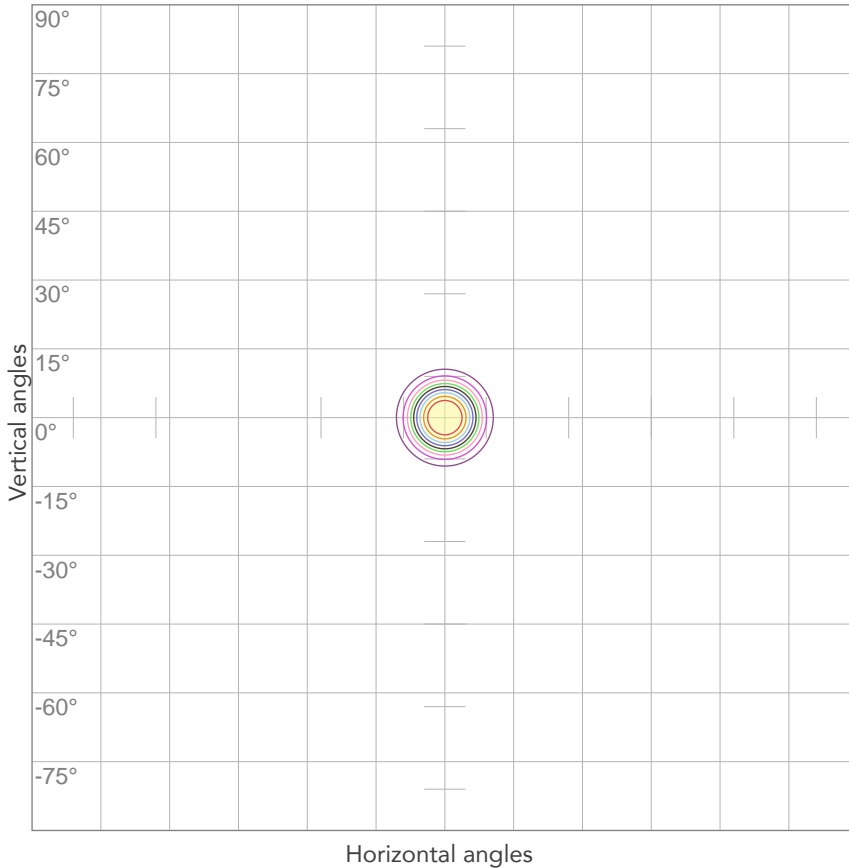

10%	1891 cd
20%	3782 cd
30%	5673 cd
40%	7563 cd
50%	9454 cd
60%	11345 cd
70%	13236 cd
80%	15127 cd

Conditions:

Number of c-planes: 2

Candela at center: 18909 cd

ISO LUX DIAGRAM

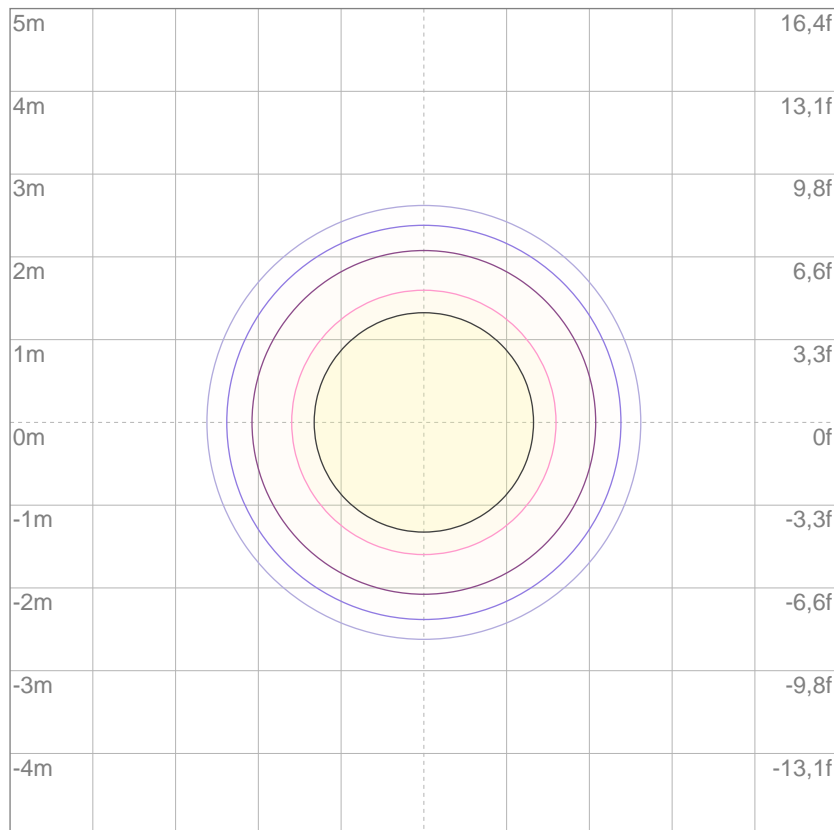

3%	5,67 lx
5%	9,45 lx
10%	18,9 lx
30%	56,7 lx
50%	94,5 lx

Conditions:

Number of c-planes: 2

Lux at center: 189 lx

Lux distribution on a surface when lamp is mounted at 10 meters from the surface.



Total lumen output:

1764 lm

Peak candela output:

6473 cd

Light quality:

CRI: 91,6

Color temperature:

5641 K

PRODUCT NAME:

ECLDISPLAY

MEASURAMENT CONDITIONS:

Beam angle:

Wash 15-30 Max Zoom

Target:

5600K

Operator:

Paolo Carvone

Date and time:

19/01/2021 18:15:07

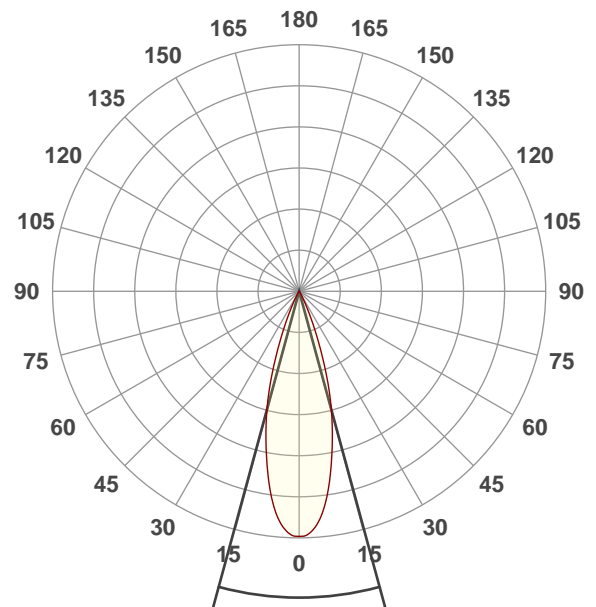

Beam angle 50%: 30,5°

Field angle 10%: 48,9°

Cut off angle 2.5%: 58,3°

Spectra

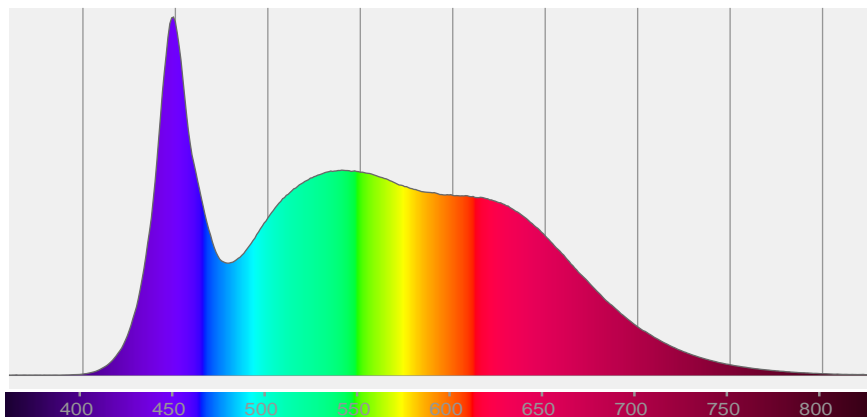

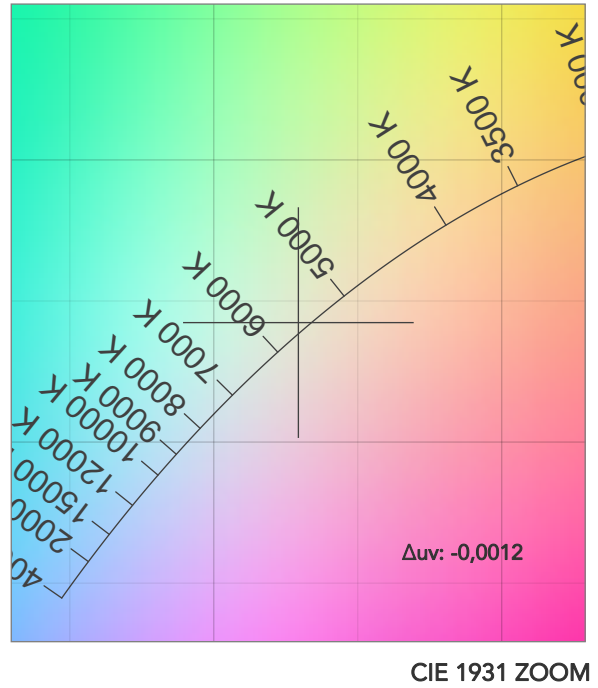
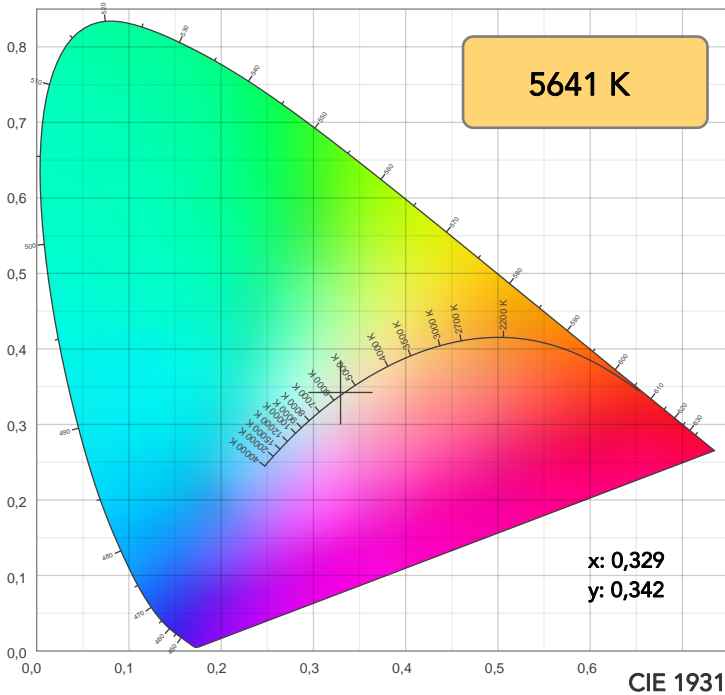

TM30: 89,2

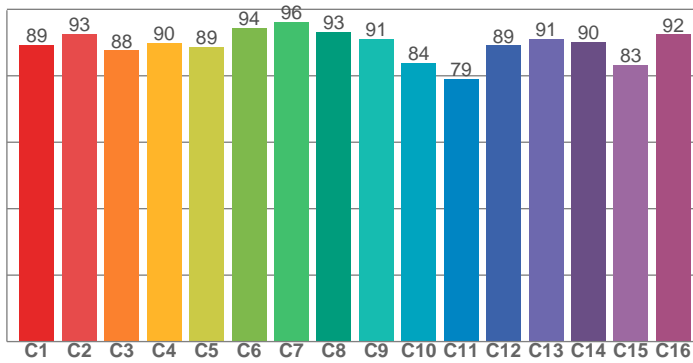

CRI: 91,6 (R1-R8)

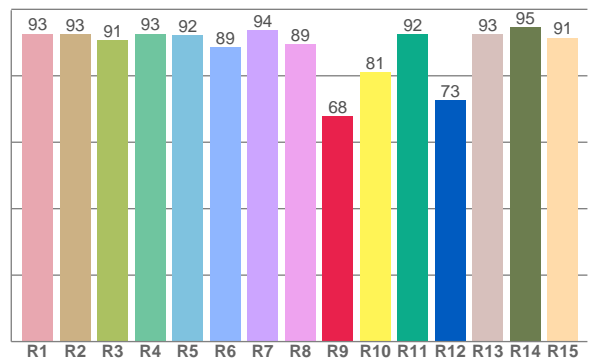

CQS: 90,2

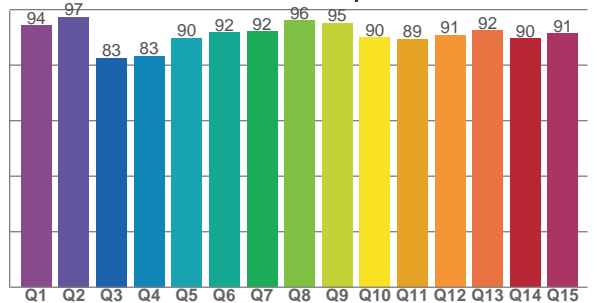

CRI R values, only R1-R8 are used to calculate final CRI value

R1	R2	R3	R4	R5	R6	R7	R8	R9	R10	R11	R12	R13	R14	R15
92,6	92,5	90,6	92,7	92,1	88,6	93,8	89,5	67,9	81,1	92,4	72,6	92,5	94,6	91,5

TM30 C values, 16 binned values out of total of 99 C values

C1	C2	C3	C4	C5	C6	C7	C8	C9	C10	C11	C12	C13	C14	C15	C16
89,3	92,6	87,7	90,0	88,7	94,4	96,1	93,2	91,2	83,9	79,0	89,1	91,1	90,1	83,2	92,4

CQS Q values

Q1	Q2	Q3	Q4	Q5	Q6	Q7	Q8	Q9	Q10	Q11	Q12	Q13	Q14	Q15
94,2	97,4	82,6	83,3	89,7	91,8	92,2	96,0	95,1	89,9	89,4	90,9	92,4	89,6	91,3

COLOR PARAMETERS

Color temperature	Color rendering index	Red component	Color fidelity	Color gamut	Color quality scale	Television lighting index	Color coordinate cie 1931	Color coordinate cie 1931	Color deviation from black body
CCT	CRI	CRI R9	TM30 Rf	TM30 Rg	CQS	TLCI	x	y	Δuv
5641 K	91,6	67,9	89,2	100,6	90,2	94	0,329	0,342	-0,0012

TM30 DETAILS

Rf 89,2
Fidelity index Rf

Rg 100,6
Gammut index

Hue Bin	R _f	Graphic shifts (%)	
		Chroma	Hue
1	89	-4%	-1%
2	93	-3%	2%
3	88	-2%	6%
4	90	0%	5%
5	89	2%	4%
6	94	3%	0%
7	96	0%	-2%
8	93	-3%	-1%
9	91	-5%	4%
10	84	-3%	8%
11	79	1%	12%
12	89	3%	6%
13	91	6%	1%
14	90	5%	-2%
15	83	8%	-11%
16	92	-1%	-4%

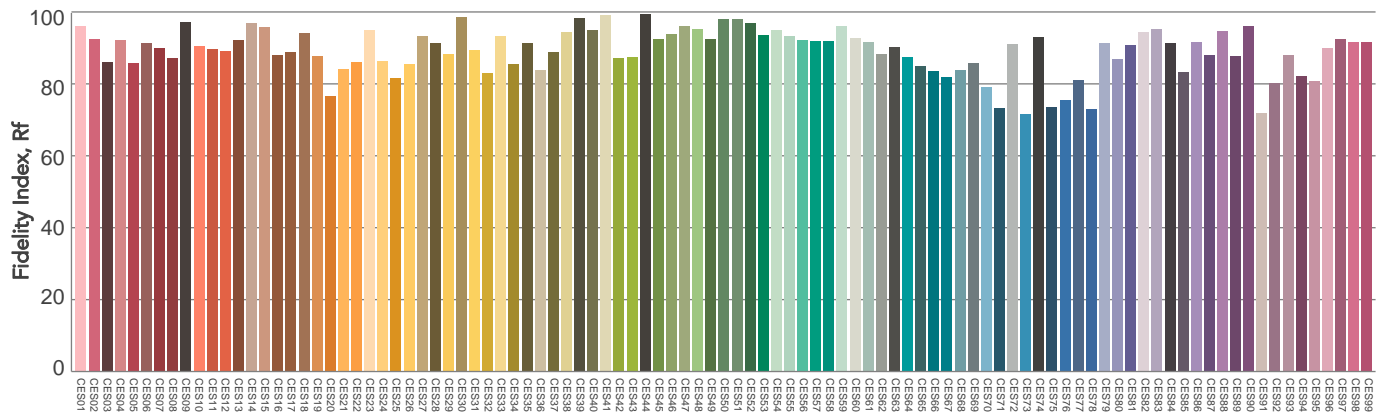
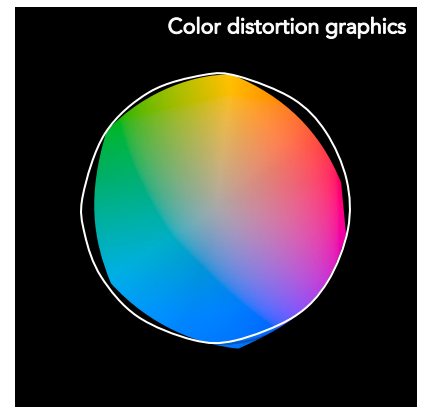
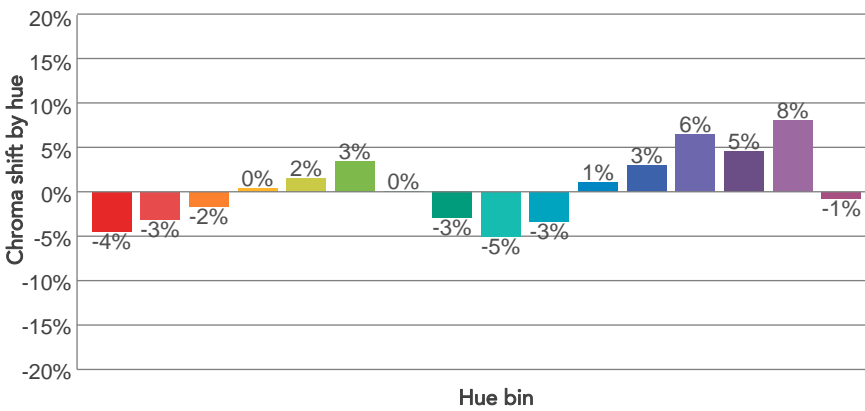
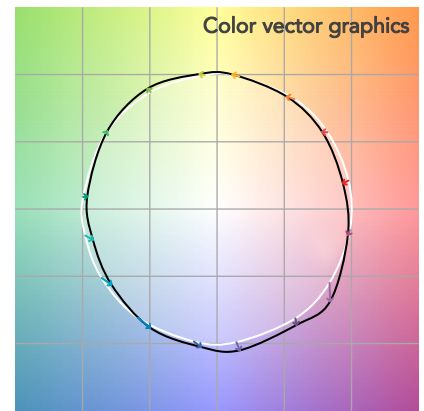
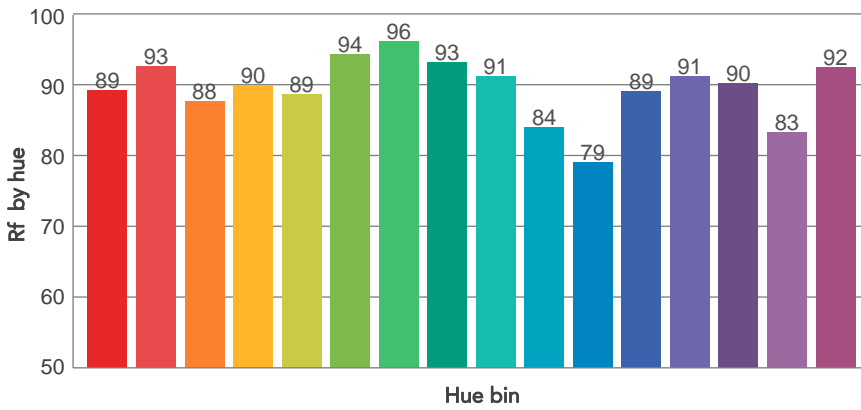
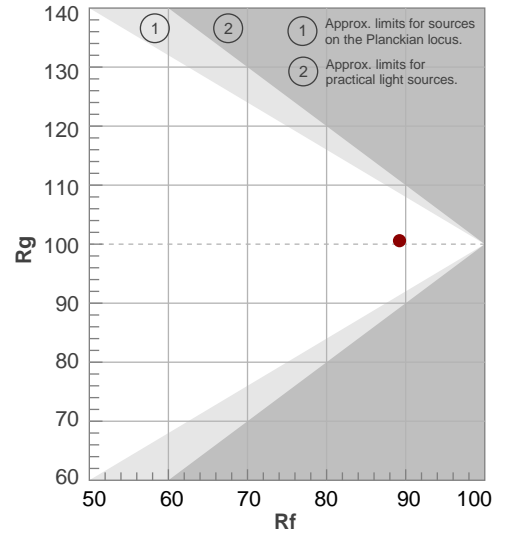

Color Evaluation Sample

BEAM DETAILS



Beam angle 50%	Field angle 10%	Cut off angle 2,5%	Intensity ratio in 120° cone	Intensity ratio in 90° cone
30,5°	48,9°	58,3°	99,9%	99,3%

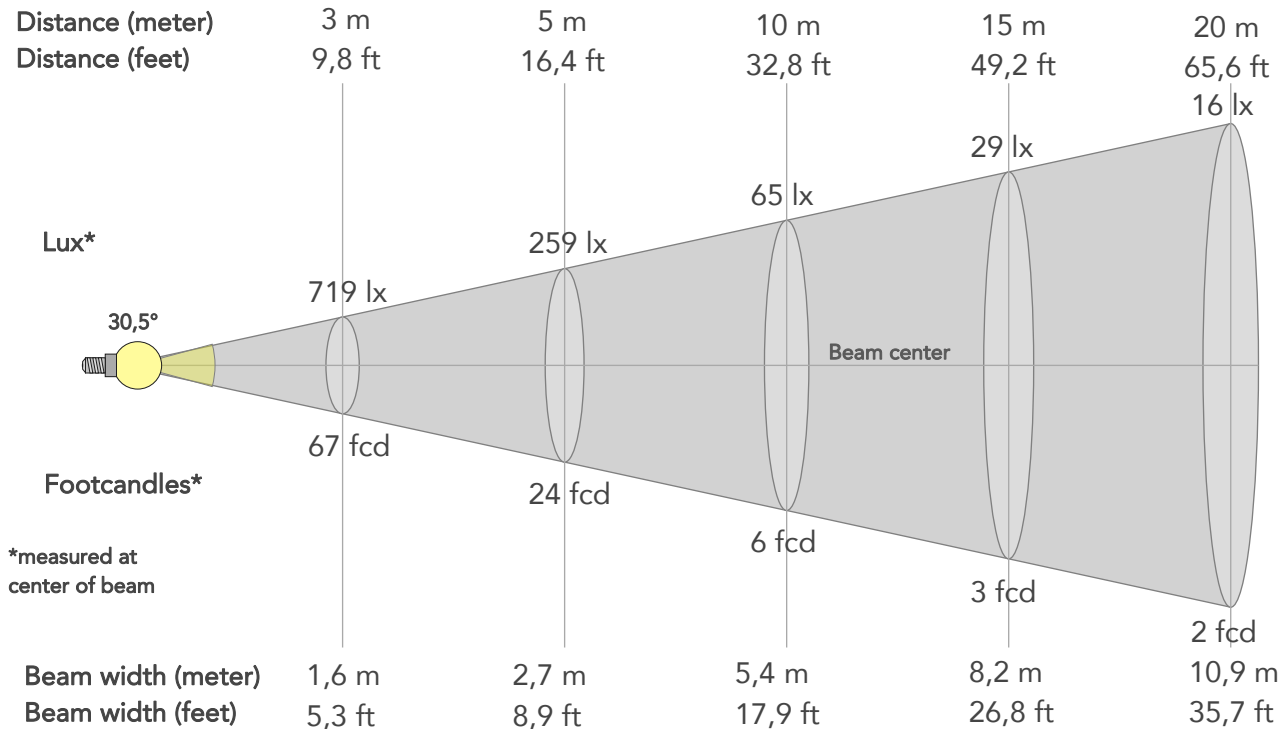

BEAM INTENSITIES AND WIDTHS

Distance	1m	2m	3m	4m	5m	7,5m	10m	15m	20m	25m	30m	40m	50m
Distance	3,3ft	6,6ft	9,8ft	13,1ft	16,4ft	24,6ft	32,8ft	49,2ft	65,6ft	82ft	98,4ft	131,2ft	164ft
Lux	6473lx	1618lx	719lx	405lx	259lx	115lx	65lx	29lx	16lx	10lx	7lx	4lx	3lx
Footcand.	601fcd	150fcd	67fcd	38fcd	24fcd	11fcd	6fcd	3fcd	2fcd	1fcd	1fcd	0fcd	0fcd
Beam wid.	0,5m	1,1m	1,6m	2,2m	2,7m	4,1m	5,4m	8,2m	10,9m	13,6m	16,3m	21,8m	27,2m
Beam wid.	1,8ft	3,6ft	5,3ft	7,1ft	8,9ft	13,4ft	17,9ft	26,8ft	35,7ft	44,6ft	53,6ft	71,4ft	89,3ft

LINEAR DISTRIBUTION DIAGRAM

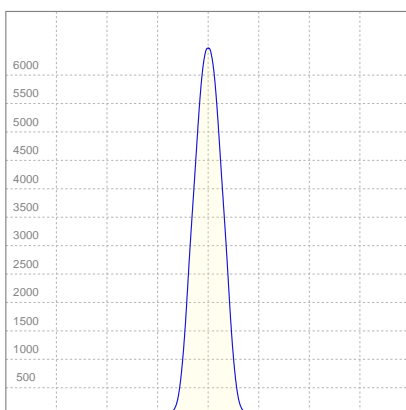

ELECTRICAL SPECIFICATIONS

Input voltage	Input current	Input power	Effeciency
224V	0,161A	33,7W	52lm/W
Power Fc			
0,94			

ISO CANDELA DIAGRAM

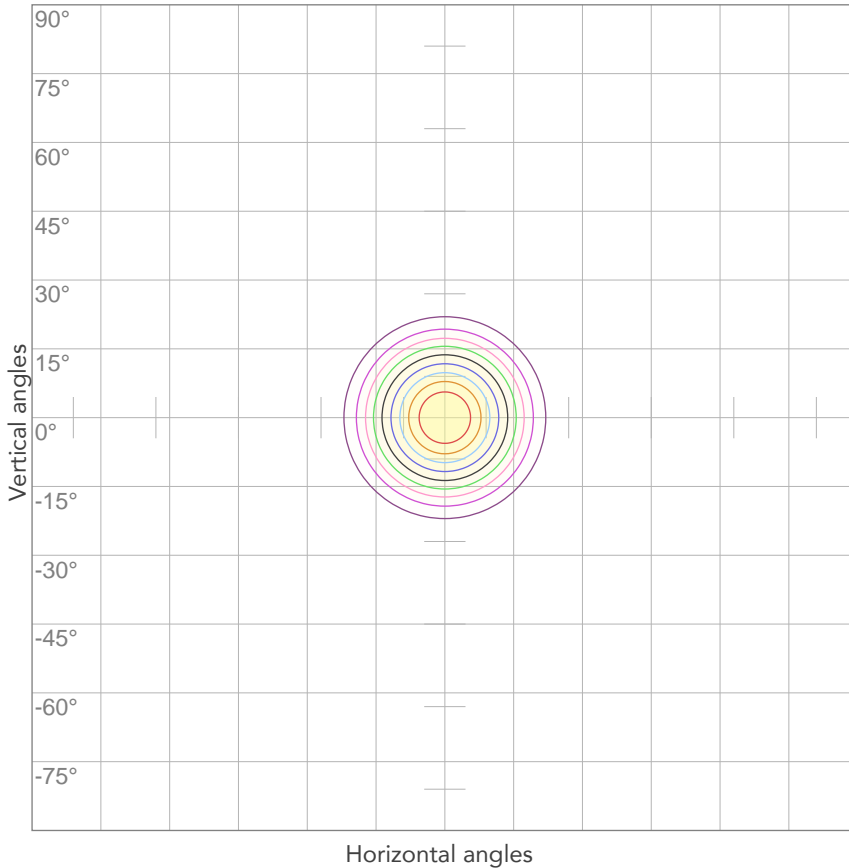

10%	647 cd
20%	1295 cd
30%	1942 cd
40%	2589 cd
50%	3236 cd
60%	3884 cd
70%	4531 cd
80%	5178 cd

Conditions:

Number of c-planes: 2

Candela at center: 6473 cd

ISO LUX DIAGRAM

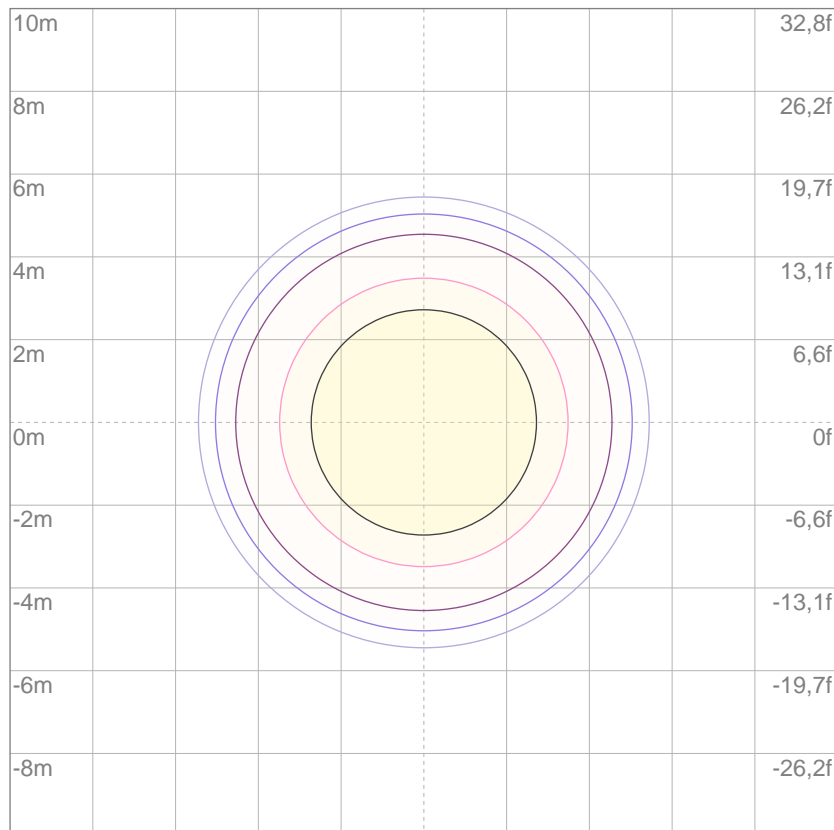

3%	1,94 lx
5%	3,24 lx
10%	6,47 lx
30%	19,4 lx
50%	32,4 lx

Conditions:

Number of c-planes: 2

Lux at center: 64,7 lx

Lux distribution on a surface when lamp is mounted at 10 meters from the surface.

Mounting height: 10 meters (33 feet)



Total lumen output:

1427 lm

Peak candela output:

17336 cd

Light quality:

CRI: 91,5

Color temperature:

5573 K

PRODUCT NAME:

ECLDISPLAY

MEASURAMENT CONDITIONS:

Beam angle:

Wash 15-30 Min Zoom

Target:

5600K

Operator:

Paolo Carvone

Date and time:

19/01/2021 18:13:35

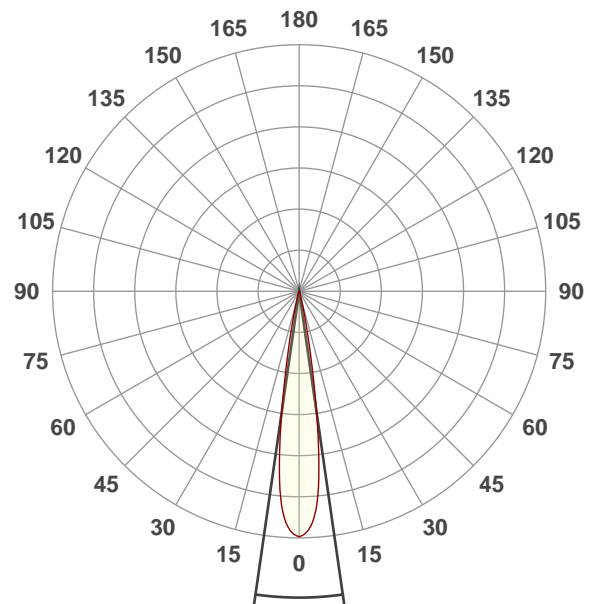

Beam angle 50%: 16,4°

Field angle 10%: 25,4°

Cut off angle 2.5%: 32,6°

Spectra

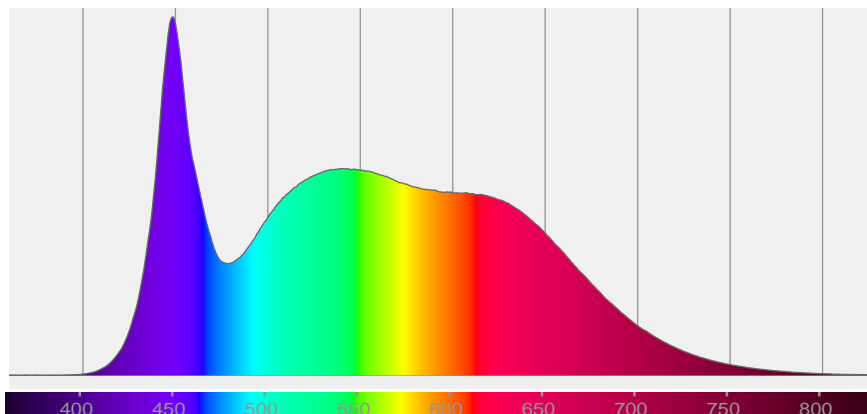

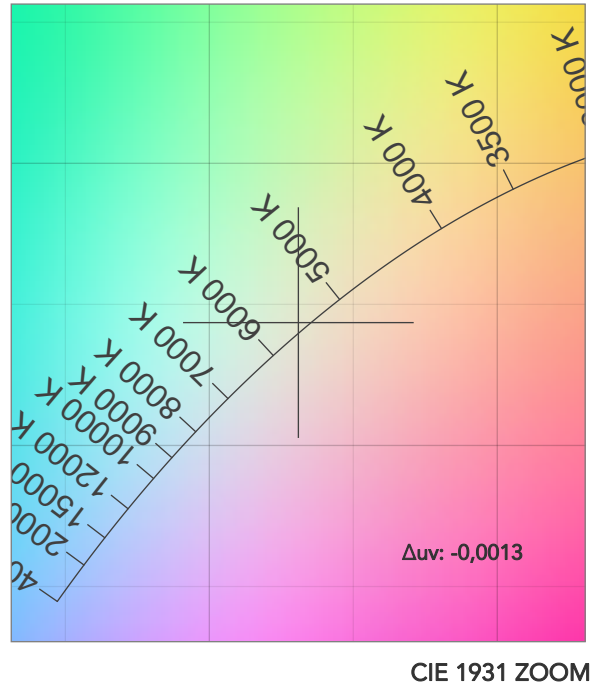
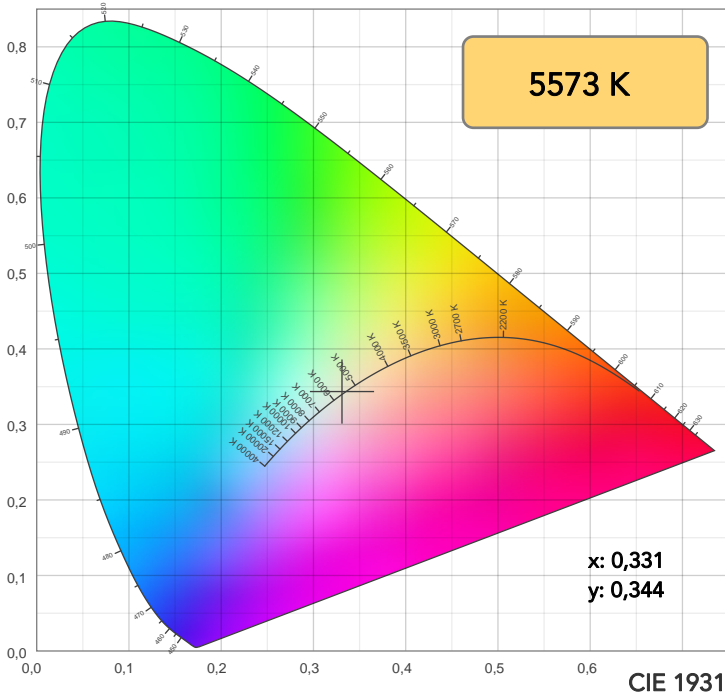

TM30: 89,2

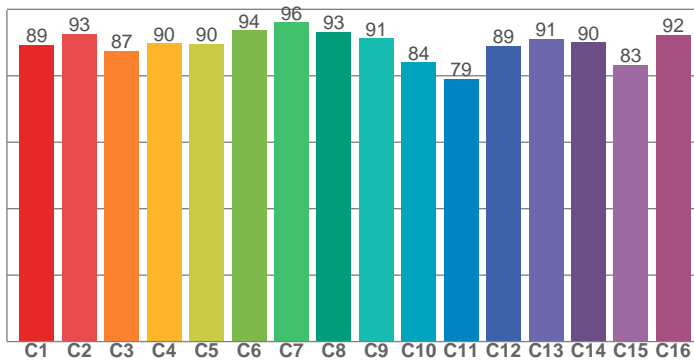

CRI: 91,5 (R1-R8)

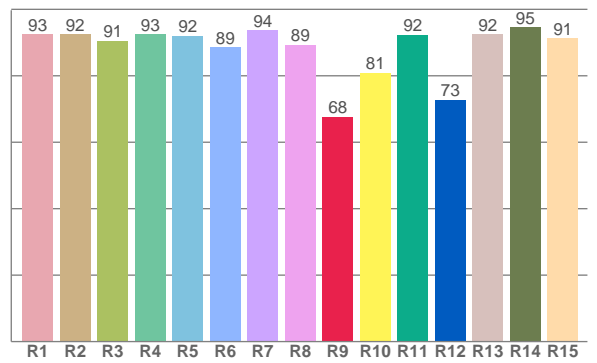

CQS: 90,1

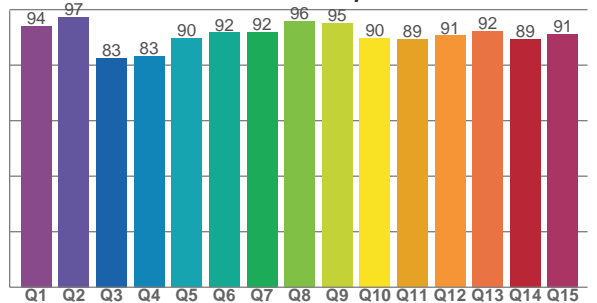

CRI R values, only R1-R8 are used to calculate final CRI value

R1	R2	R3	R4	R5	R6	R7	R8	R9	R10	R11	R12	R13	R14	R15
92,6	92,4	90,6	92,6	92,1	88,6	93,6	89,3	67,6	80,9	92,4	72,8	92,4	94,6	91,4

TM30 C values, 16 binned values out of total of 99 C values

C1	C2	C3	C4	C5	C6	C7	C8	C9	C10	C11	C12	C13	C14	C15	C16
89,2	92,5	87,5	89,8	89,7	93,7	96,1	93,2	91,3	84,0	79,0	89,0	91,1	90,0	83,3	92,3

CQS Q values

Q1	Q2	Q3	Q4	Q5	Q6	Q7	Q8	Q9	Q10	Q11	Q12	Q13	Q14	Q15
94,1	97,3	82,5	83,3	89,7	91,7	92,0	96,0	95,1	89,8	89,3	90,7	92,3	89,5	91,2

COLOR PARAMETERS

Color temperature	Color rendering index	Red component	Color fidelity	Color gamut	Color quality scale	Television lighting index	Color coordinate cie 1931	Color coordinate cie 1931	Color deviation from black body
CCT	CRI	CRI R9	TM30 Rf	TM30 Rg	CQS	TLCI	x	y	Δuv
5573 K	91,5	67,6	89,2	100,7	90,1	94	0,331	0,344	-0,0013

TM30 DETAILS

Rf 89,2
Fidelity index Rf

Rg 100,7
Gammut index

Hue Bin	R _f	Graphic shifts (%)	
		Chroma	Hue
1	89	-4%	-1%
2	93	-3%	2%
3	87	-2%	6%
4	90	0%	5%
5	90	2%	4%
6	94	4%	0%
7	96	0%	-2%
8	93	-3%	-1%
9	91	-5%	4%
10	84	-3%	8%
11	79	1%	12%
12	89	3%	6%
13	91	6%	1%
14	90	5%	-2%
15	83	8%	-11%
16	92	-1%	-4%

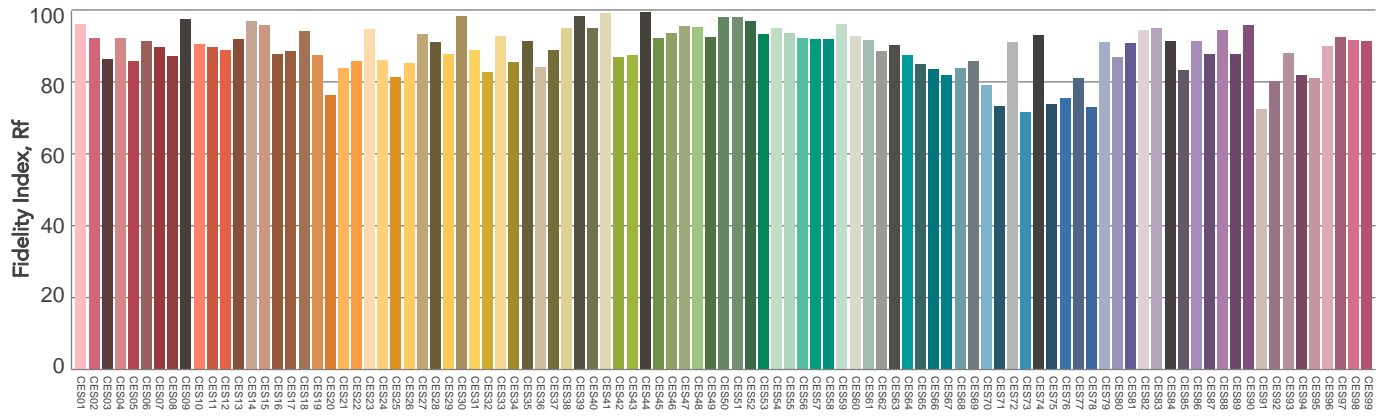
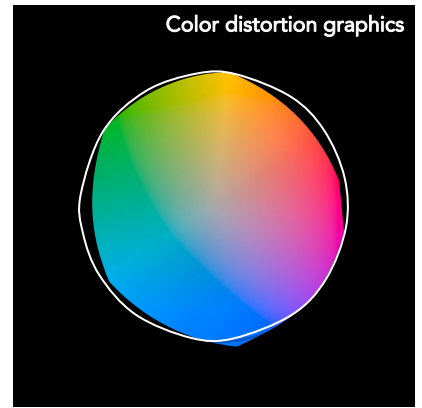
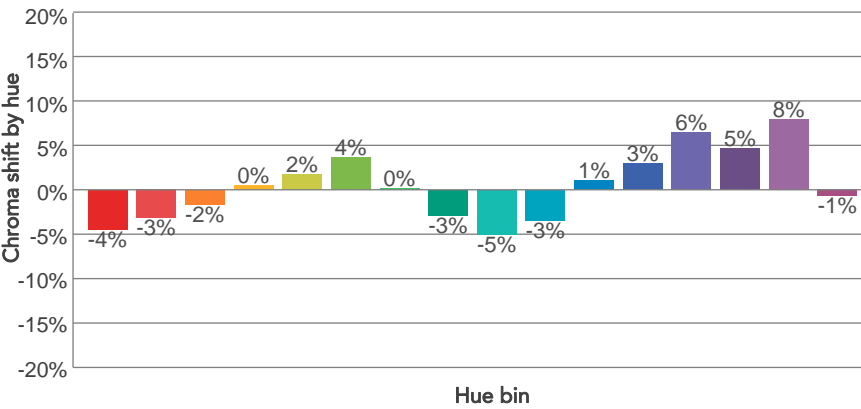
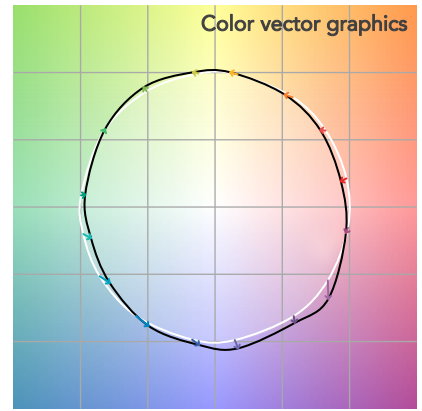
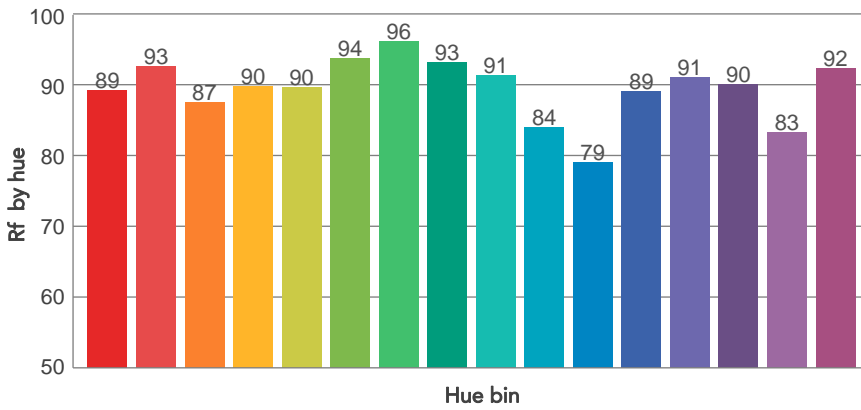
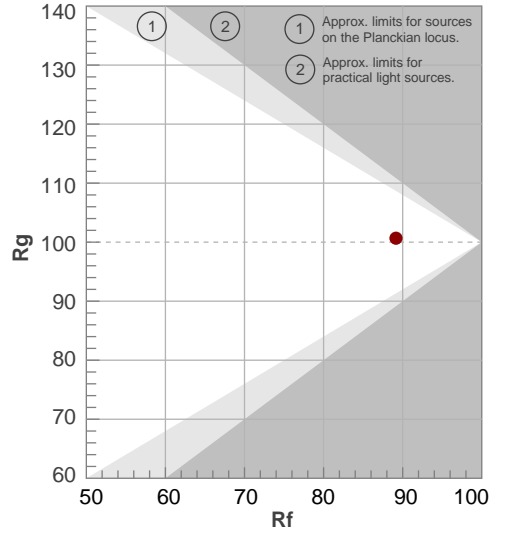

BEAM DETAILS



Beam angle 50%	Field angle 10%	Cut off angle 2,5%	Intensity ratio in 120° cone	Intensity ratio in 90° cone
16,4°	25,4°	32,6°	100,0%	99,9%

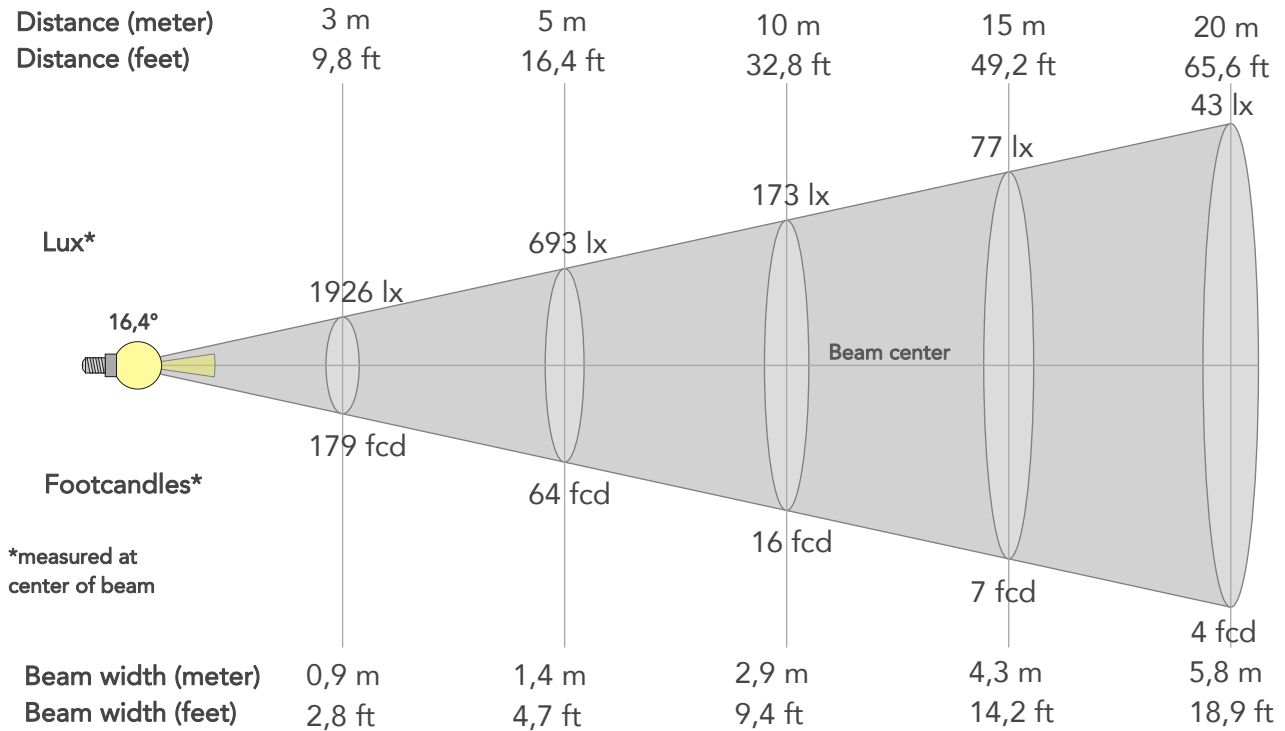

BEAM INTENSITIES AND WIDTHS

Distance	1m	2m	3m	4m	5m	7,5m	10m	15m	20m	25m	30m	40m	50m
Distance	3,3ft	6,6ft	9,8ft	13,1ft	16,4ft	24,6ft	32,8ft	49,2ft	65,6ft	82ft	98,4ft	131,2ft	164ft
Lux	17336lx	4334lx	1926lx	1084lx	693lx	308lx	173lx	77lx	43lx	28lx	19lx	11lx	7lx
Footcand.	1611fcd	403fcd	179fcd	101fcd	64fcd	29fcd	16fcd	7fcd	4fcd	3fcd	2fcd	1fcd	1fcd
Beam wid.	0,3m	0,6m	0,9m	1,2m	1,4m	2,2m	2,9m	4,3m	5,8m	7,2m	8,6m	11,5m	14,4m
Beam wid.	1ft	1,9ft	2,8ft	3,8ft	4,7ft	7,1ft	9,4ft	14,2ft	18,9ft	23,6ft	28,3ft	37,8ft	47,2ft

LINEAR DISTRIBUTION DIAGRAM

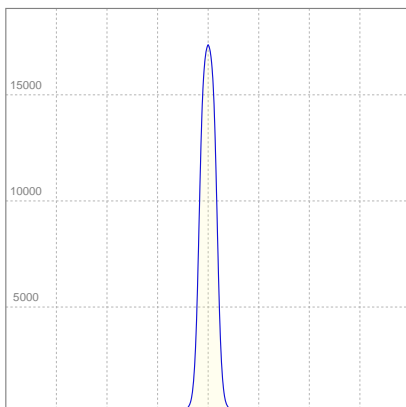

ELECTRICAL SPECIFICATIONS

Input voltage	Input current	Input power	Effeciency
224V	0,161A	33,7W	42lm/W
Power Fc			
0,94			

ISO CANDELA DIAGRAM

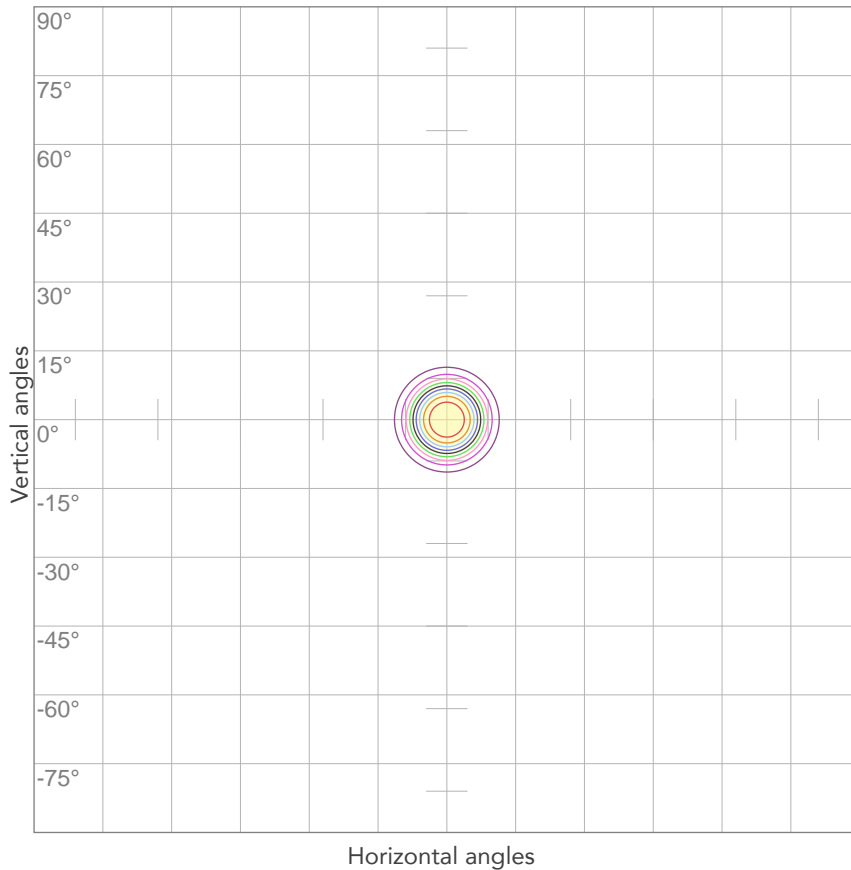

10%	1734 cd
20%	3467 cd
30%	5201 cd
40%	6934 cd
50%	8668 cd
60%	10402 cd
70%	12135 cd
80%	13869 cd

Conditions:

Number of c-planes: 2

Candela at center: 17336 cd

ISO LUX DIAGRAM

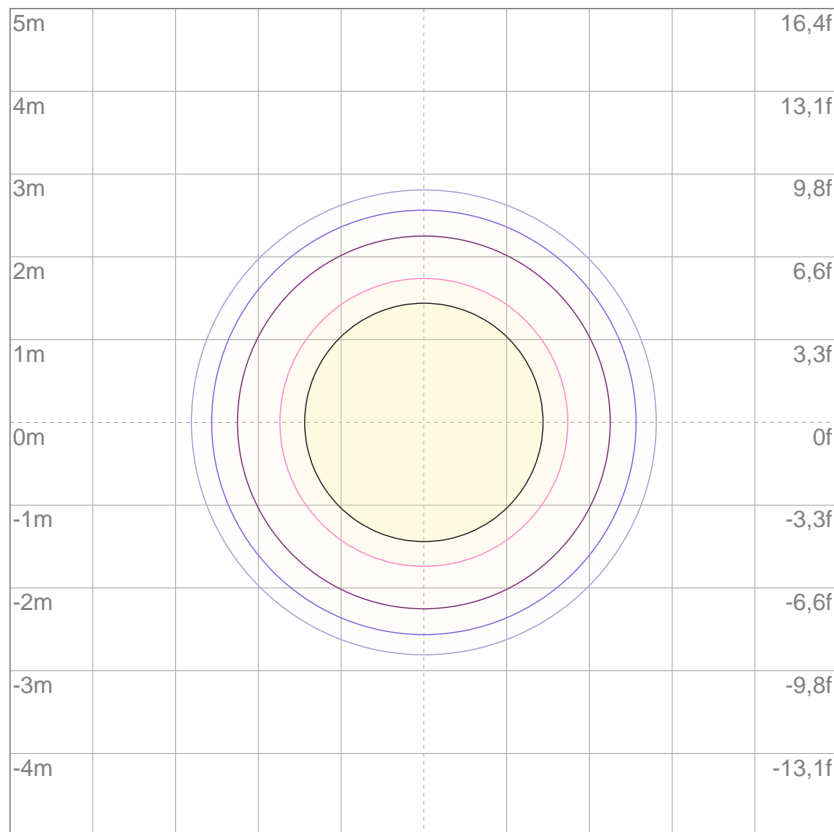

3%	5,20 lx
5%	8,67 lx
10%	17,3 lx
30%	52,0 lx
50%	86,7 lx

Conditions:

Number of c-planes: 2

Lux at center: 173 lx

Lux distribution on a surface when lamp is mounted at 10 meters from the surface.

Mounting height: 10 meters (33 feet)