

# Photometric Test Report



## ECLDISPLAYUN

ZOOMABLE WASH LENS 25-50°

25W White LED gallery light, with universal control DMX / Dali / Knob-dimming /

Phase-cut dimming

## CONTENTS

Table of contents	2
Testing process	3
Color temperature 2700K Max Zoom	4
Color temperature 2700K Min Zoom	9
Color temperature 3000K Max Zoom	14
Color temperature 3000K Min Zoom	19
Color temperature 4000K Max Zoom	24
Color temperature 4000K Min Zoom	29
Color temperature 5600K Max Zoom	34
Color temperature 5600K Min Zoom	39

## TESTING PROCESS

Prolights has its own optical testing laboratory in order to provide accurate photometric reports for its lighting products. The testing laboratory contains certain variety of precise lighting measurement systems that ensure an optimal reading of all the characteristic parameters of the lighting devices. All measurements are made at a controlled room temperature of 20°C without any external light sources. This photometric report is obtained through the data measured by a high precision measurement system and analyzed by a dedicate software.

### **Prolights measurement instrument**

Prolights measurement instrument is a complete measurement system for any light source. It's equipped with two-axis goniometer, that enables to measure the full 3D distribution field of the light source. This instrument measures the light intensity, the beam angle and the most significative colors parameters, like color temperature, spectral distribution, CRI, CQS, TM-30 with a very high accuracy rate.

**Please Note:** All measurements are made with light source at operating temperature. Before starting the measurement, the instrument analyzes the process of the light source during the heating phase. The measuring process of all the parameters begins only when the light emission is stable, that is with a variation of less than 0.5% in a 15 minutes time frame.

### **Prolights measurement software**

The software provides user friendly interface for the operator who does the measurements, and it also analyzes and processes all the collected data by the instrument. With this software it is possible to see the measured data in real-time and it is possible to examine all the measured data and graphics afterwards as well. All information is collected in a specific Prolights template, and the software creates also IES and LDT files, which are widely used to transfer the photometric data, and to develop lighting system.

Additionally, the fixtures are rechecked using various hand-held instruments like Sekonic C-700 and Gossen Mavospec Base, this is done to ensure, that the data in the photometric report are as accurate as possible.



Total lumen output:

1638 lm

Peak candela output:

2389 cd

Light quality:

CRI: 90,6

Color temperature:

2833 K

**PRODUCT NAME:**  
ECLDISPLAY

**MEASUREMENT CONDITIONS:**

Beam angle:  
Wash 25-50 Max Zoom

Target:  
2700K

Operator:  
Paolo Carvone

Date and time:  
19/01/2021 17:18:31

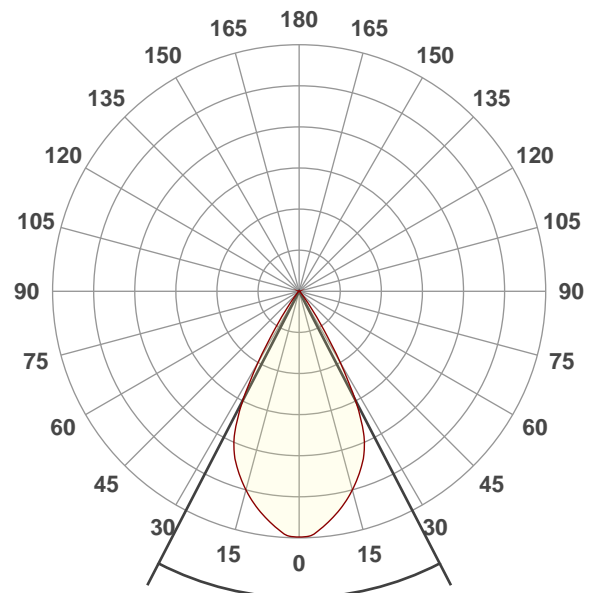

Beam angle 50%: 54,6°  
Field angle 10%: 70,3°  
Cut off angle 2.5%: 81,7°

Spectra



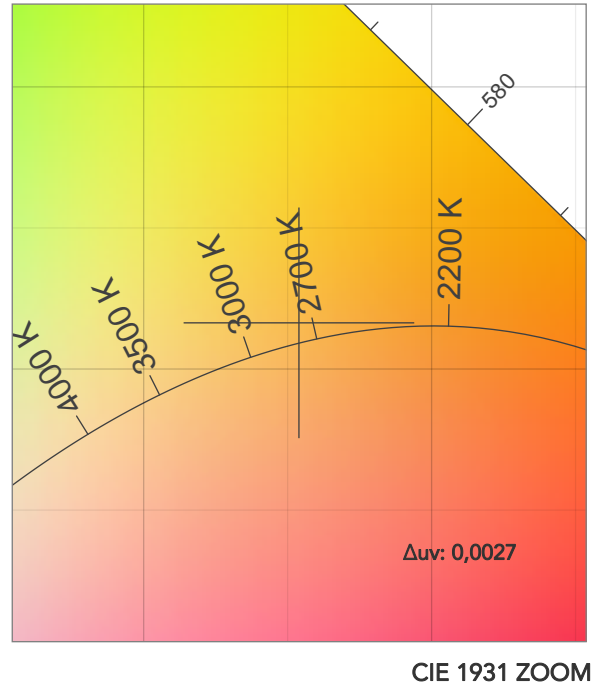
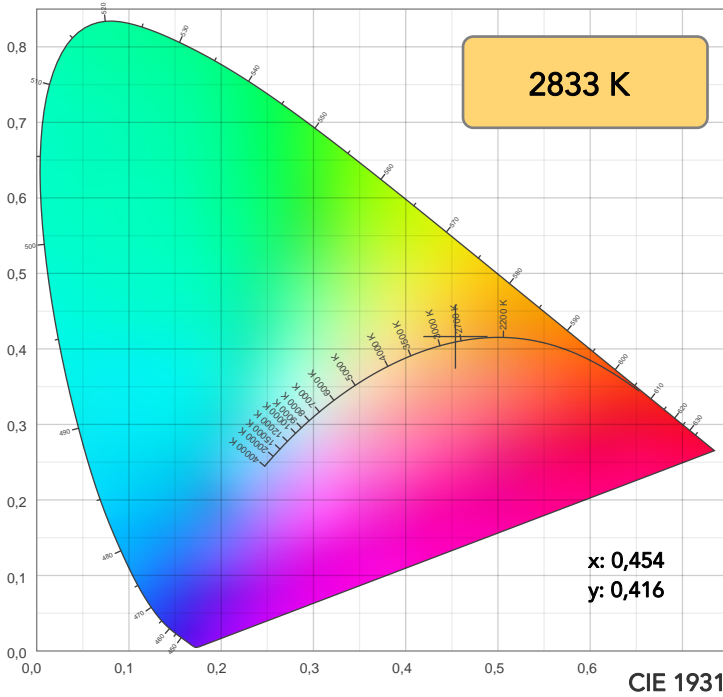

TM30: 89,7

CRI: 90,6 (R1-R8)

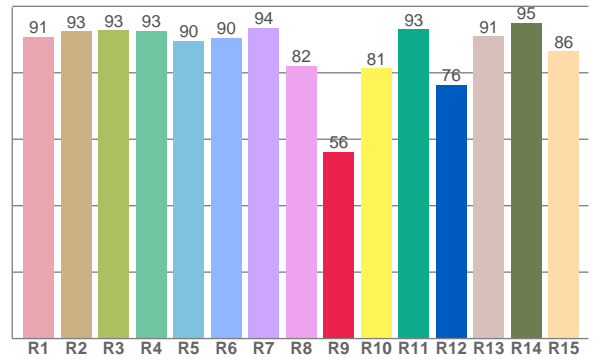
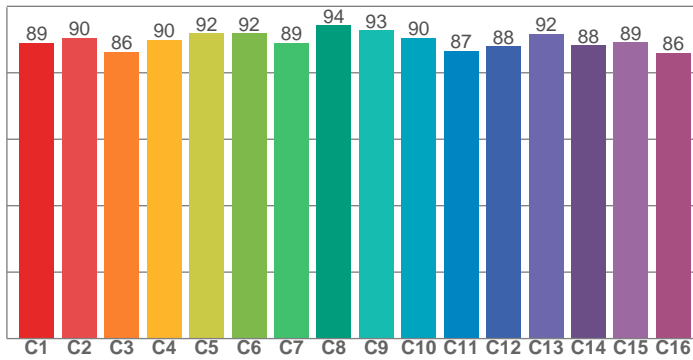

CRI R values, only R1-R8 are used to calculate final CRI value

R1	R2	R3	R4	R5	R6	R7	R8	R9	R10	R11	R12	R13	R14	R15
90,9	92,5	92,9	92,6	89,7	90,5	93,5	82,2	56,2	81,5	93,1	76,4	90,9	95,1	86,4

TM30 C values, 16 binned values out of total of 99 C values

C1	C2	C3	C4	C5	C6	C7	C8	C9	C10	C11	C12	C13	C14	C15	C16
89,1	90,4	86,2	89,8	91,9	91,8	89,0	94,3	92,7	90,5	86,6	88,0	91,7	88,2	89,2	85,9

CQS Q values

Q1	Q2	Q3	Q4	Q5	Q6	Q7	Q8	Q9	Q10	Q11	Q12	Q13	Q14	Q15
86,5	96,4	87,6	88,2	88,8	87,3	89,2	93,0	95,9	92,1	91,0	91,6	91,9	85,0	85,5

CQS: 89,3

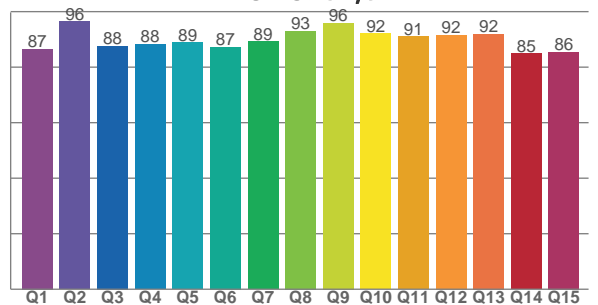

COLOR PARAMETERS

Color temperature	Color rendering index	Red component	Color fidelity	Color gamut	Color quality scale	Television lighting index	Color coordinate cie 1931	Color coordinate cie 1931	Color deviation from black body
CCT	CRI	CRI R9	TM30 Rf	TM30 Rg	CQS	TLCI	x	y	Δuv
2833 K	90,6	56,2	89,7	100,2	89,3	88	0,454	0,416	0,0027

# TM30 DETAILS

**Rf 89,7**  
Fidelity index Rf

**Rg 100,2**  
Gammut index

Hue Bin	R <sub>f</sub>	Graphic shifts (%)	
		Chroma	Hue
1	89	-5%	-2%
2	90	-4%	3%
3	86	-2%	6%
4	90	1%	5%
5	92	4%	5%
6	92	5%	0%
7	89	1%	-6%
8	94	0%	-3%
9	93	-3%	-2%
10	90	-4%	3%
11	87	-2%	8%
12	88	4%	4%
13	92	4%	-2%
14	88	5%	-6%
15	89	1%	-6%
16	86	-2%	-10%

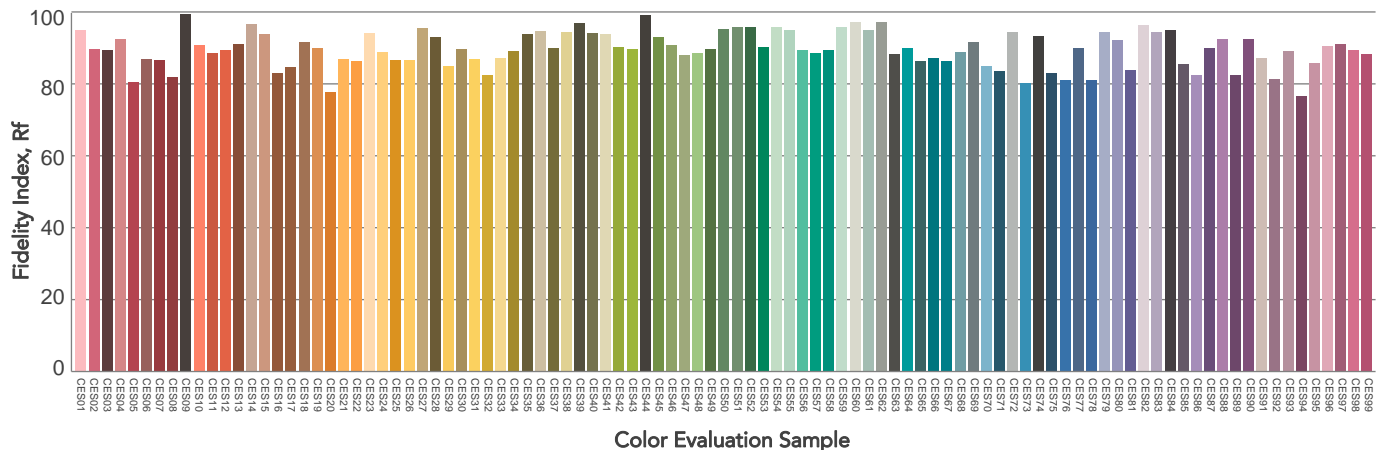
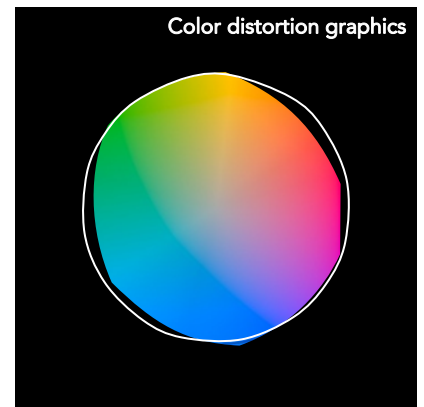
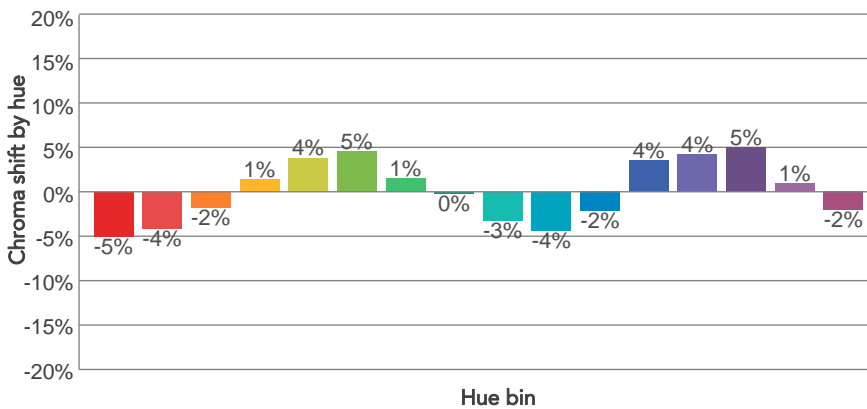
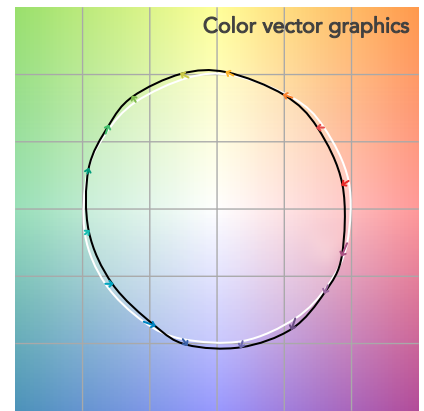
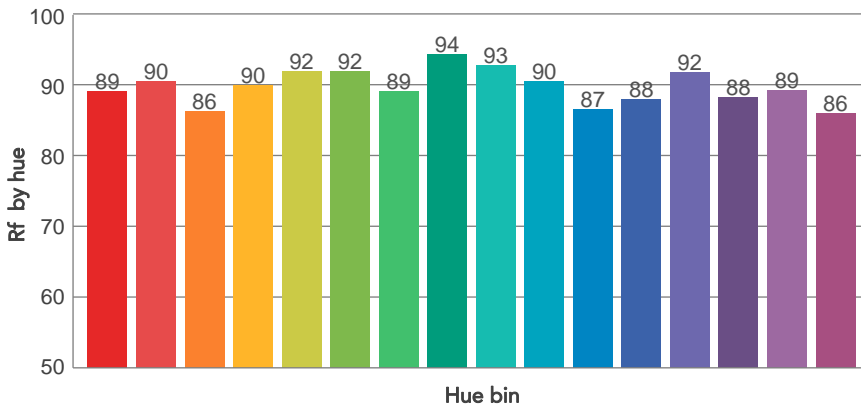
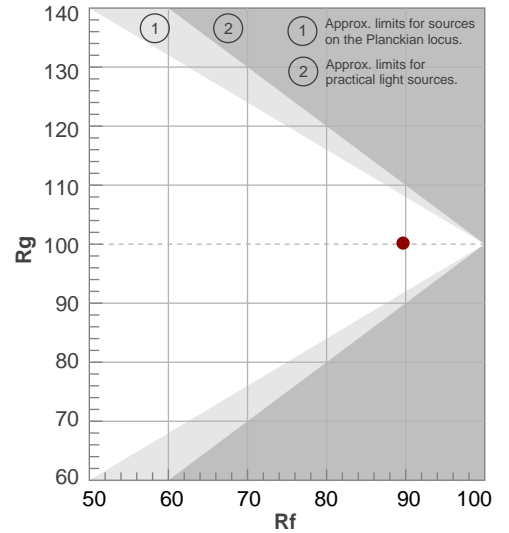

# BEAM DETAILS



Beam angle 50%	Field angle 10%	Cut off angle 2,5%	Intensity ratio in 120° cone	Intensity ratio in 90° cone
54,6°	70,3°	81,7°	99,8%	98,7%

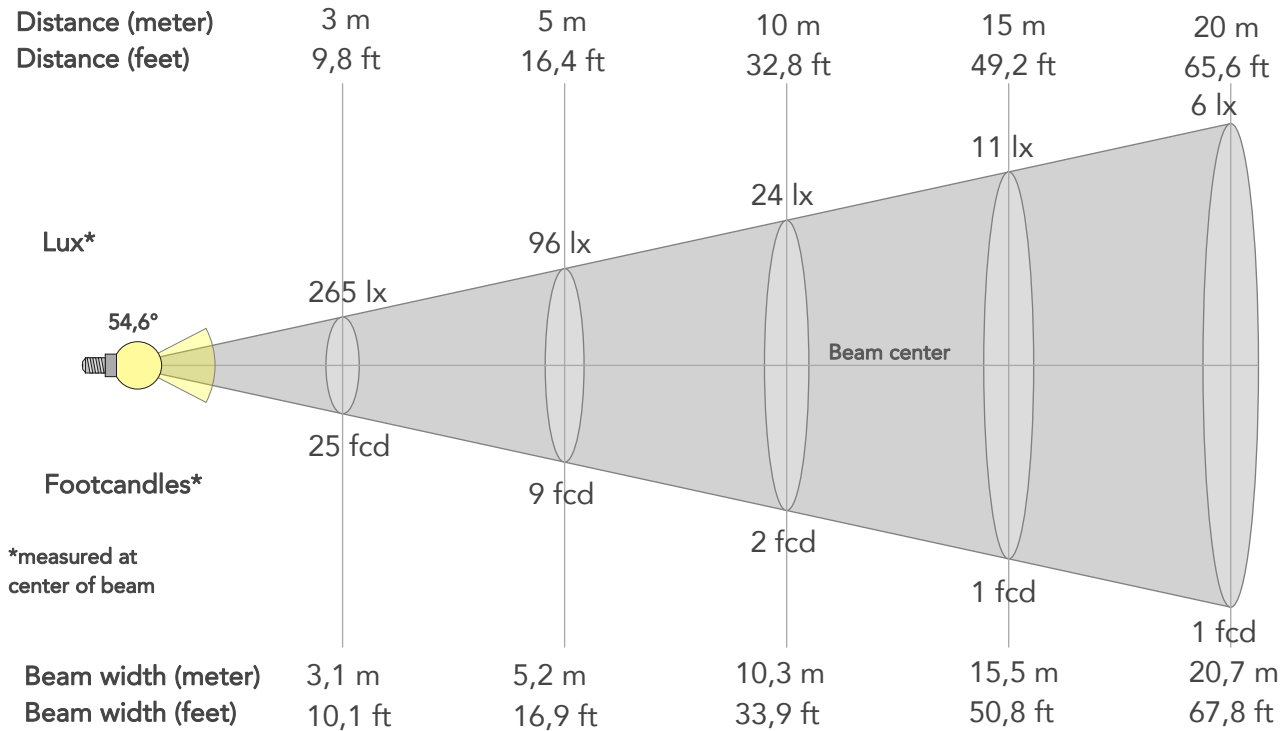

## BEAM INTENSITIES AND WIDTHS

Distance	1m	2m	3m	4m	5m	7,5m	10m	15m	20m	25m	30m	40m	50m
Distance	3,3ft	6,6ft	9,8ft	13,1ft	16,4ft	24,6ft	32,8ft	49,2ft	65,6ft	82ft	98,4ft	131,2ft	164ft
Lux	2389lx	597lx	265lx	149lx	96lx	42lx	24lx	11lx	6lx	4lx	3lx	1lx	1lx
Footcand.	222fcd	55fcd	25fcd	14fcd	9fcd	4fcd	2fcd	1fcd	1fcd	0fcd	0fcd	0fcd	0fcd
Beam wid.	1m	2,1m	3,1m	4,1m	5,2m	7,7m	10,3m	15,5m	20,7m	25,8m	31m	41,3m	51,6m
Beam wid.	3,4ft	6,8ft	10,1ft	13,5ft	16,9ft	25,4ft	33,9ft	50,8ft	67,8ft	84,7ft	101,6ft	135,5ft	169,4ft

## LINEAR DISTRIBUTION DIAGRAM

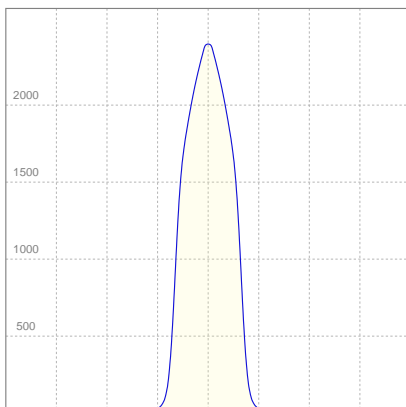

## ELECTRICAL SPECIFICATIONS

Input voltage	Input current	Input power	Effeciency
223V	0,161A	33,6W	49lm/W

Power Fc
0,95

## ISO CANDELA DIAGRAM

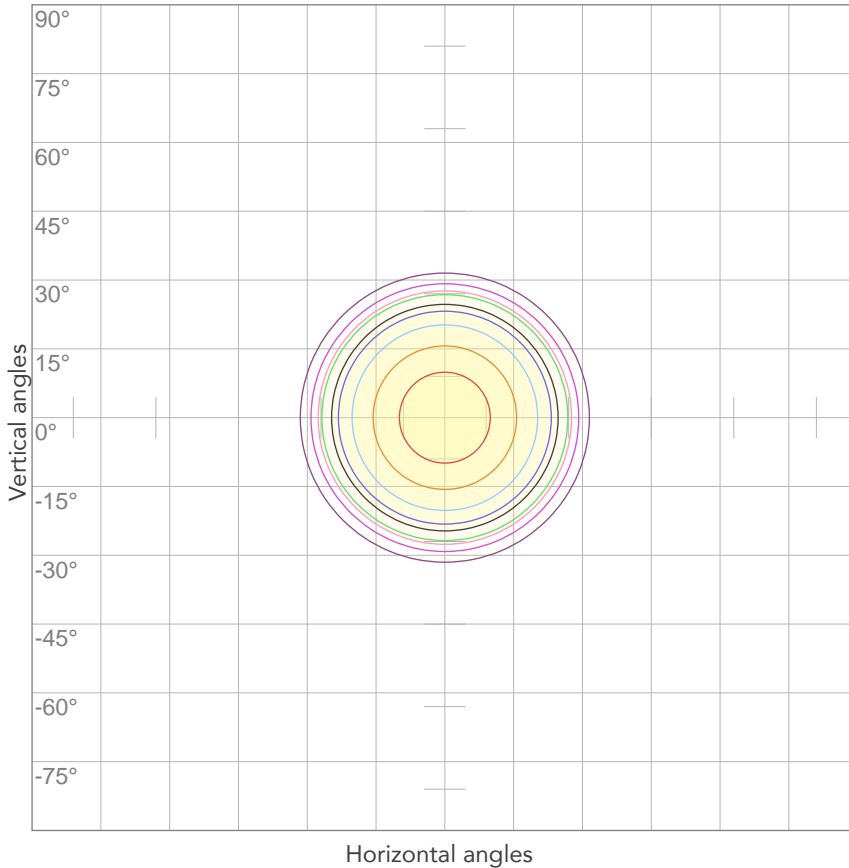

10%	239 cd
20%	478 cd
30%	717 cd
40%	956 cd
50%	1194 cd
60%	1433 cd
70%	1672 cd
80%	1911 cd

Conditions:

Number of c-planes: 2

Candela at center: 2389 cd

## ISO LUX DIAGRAM

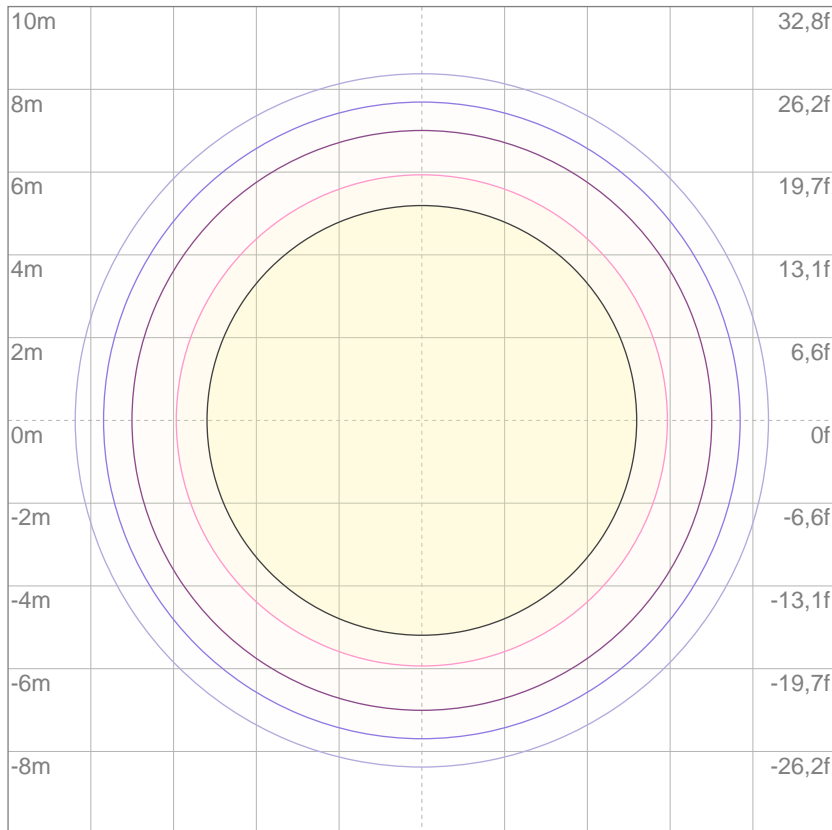

Mounting height: 10 meters (33 feet)

3%	0,717 lx
5%	1,19 lx
10%	2,39 lx
30%	7,17 lx
50%	11,9 lx

Conditions:

Number of c-planes: 2

Lux at center: 23,9 lx

*Lux distribution on a surface when lamp is mounted at 10 meters from the surface.*





Total lumen output:

1183 lm

Peak candela output:

6780 cd

Light quality:

CRI: 90,7

Color temperature:

2827 K

PRODUCT NAME:  
ECLDISPLAY

MEASUREMENT CONDITIONS:

Beam angle:  
Wash 25-50 Min Zoom

Target:  
2700K

Operator:  
Paolo Carvone

Date and time:  
19/01/2021 17:16:54

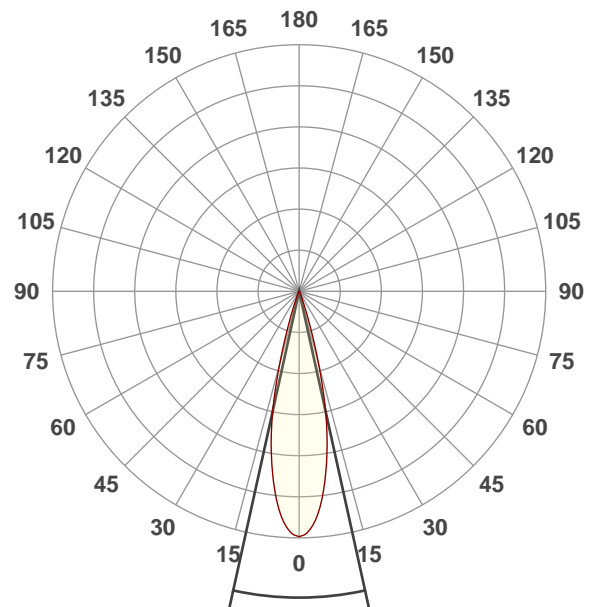

Spectra

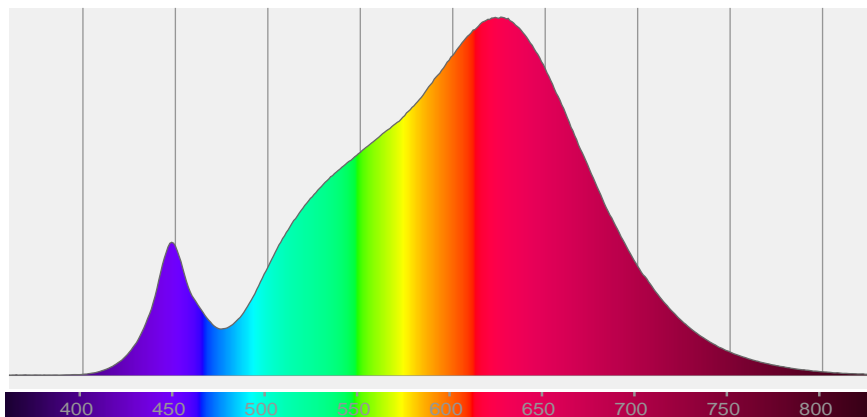

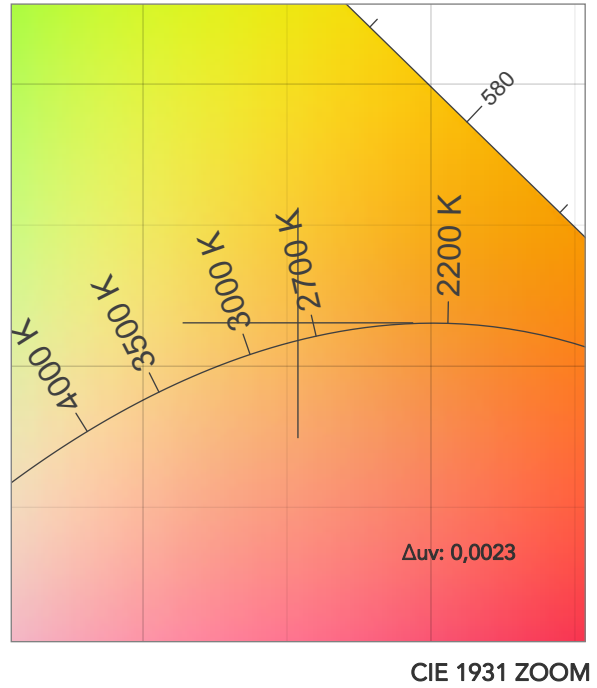
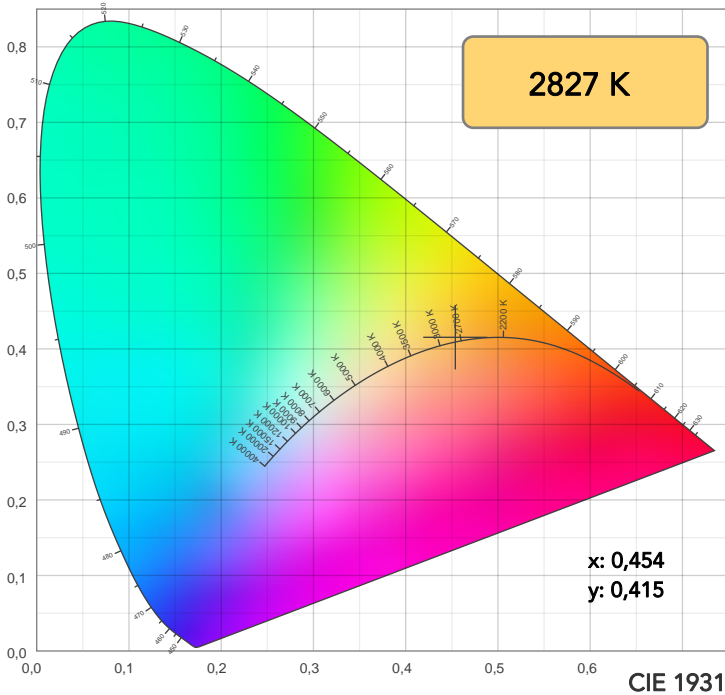

TM30: 89,5

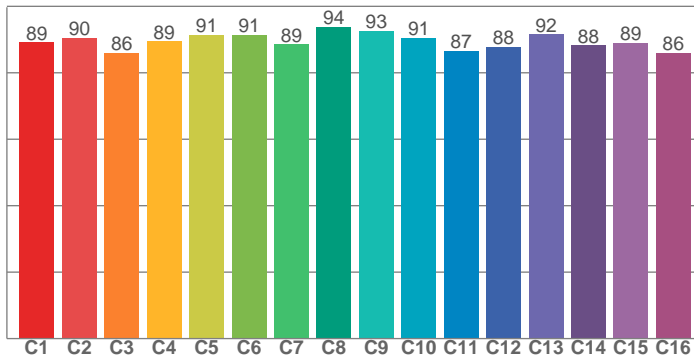

CRI: 90,7 (R1-R8)

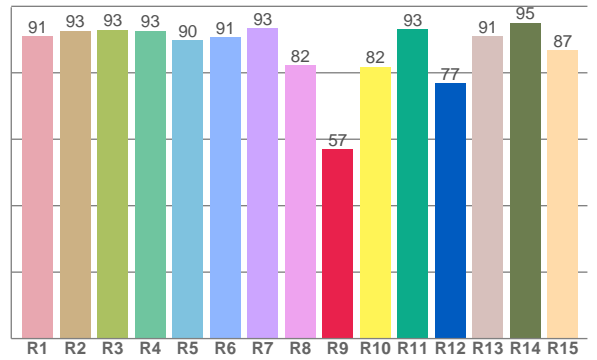

CQS: 89,3

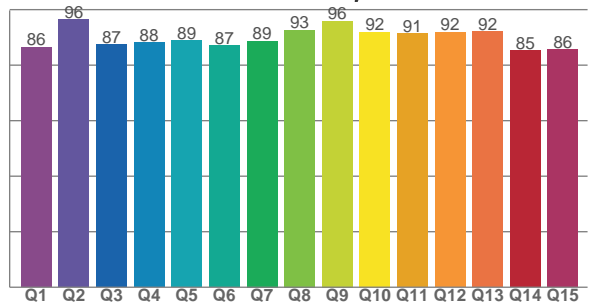

CRI R values, only R1-R8 are used to calculate final CRI value

R1	R2	R3	R4	R5	R6	R7	R8	R9	R10	R11	R12	R13	R14	R15
91,0	92,7	92,9	92,7	89,9	90,7	93,4	82,4	56,9	81,8	93,2	76,9	91,1	95,1	86,7

TM30 C values, 16 binned values out of total of 99 C values

C1	C2	C3	C4	C5	C6	C7	C8	C9	C10	C11	C12	C13	C14	C15	C16
89,1	90,5	85,9	89,5	91,5	91,3	88,5	93,9	92,6	90,5	86,6	87,9	91,6	88,2	89,0	86,0

CQS Q values

Q1	Q2	Q3	Q4	Q5	Q6	Q7	Q8	Q9	Q10	Q11	Q12	Q13	Q14	Q15
86,4	96,5	87,5	88,2	88,8	87,1	88,7	92,7	95,9	91,9	91,3	91,8	92,1	85,2	85,6

COLOR PARAMETERS

Color temperature	Color rendering index	Red component	Color fidelity	Color gamut	Color quality scale	Television lighting index	Color coordinate cie 1931	Color coordinate cie 1931	Color deviation from black body
CCT	CRI	CRI R9	TM30 Rf	TM30 Rg	CQS	TLCI	x	y	Δuv
2827 K	90,7	56,9	89,5	100,5	89,3	88	0,454	0,415	0,0023

# TM30 DETAILS

**Rf 89,5**  
Fidelity index Rf

**Rg 100,5**  
Gammut index

Hue Bin	R <sub>f</sub>	Graphic shifts (%)	
		Chroma	Hue
1	89	-5%	-2%
2	90	-4%	3%
3	86	-2%	6%
4	89	2%	6%
5	91	4%	5%
6	91	5%	0%
7	89	2%	-6%
8	94	0%	-4%
9	93	-3%	-2%
10	91	-4%	3%
11	87	-2%	8%
12	88	4%	4%
13	92	4%	-2%
14	88	5%	-6%
15	89	1%	-6%
16	86	-2%	-10%

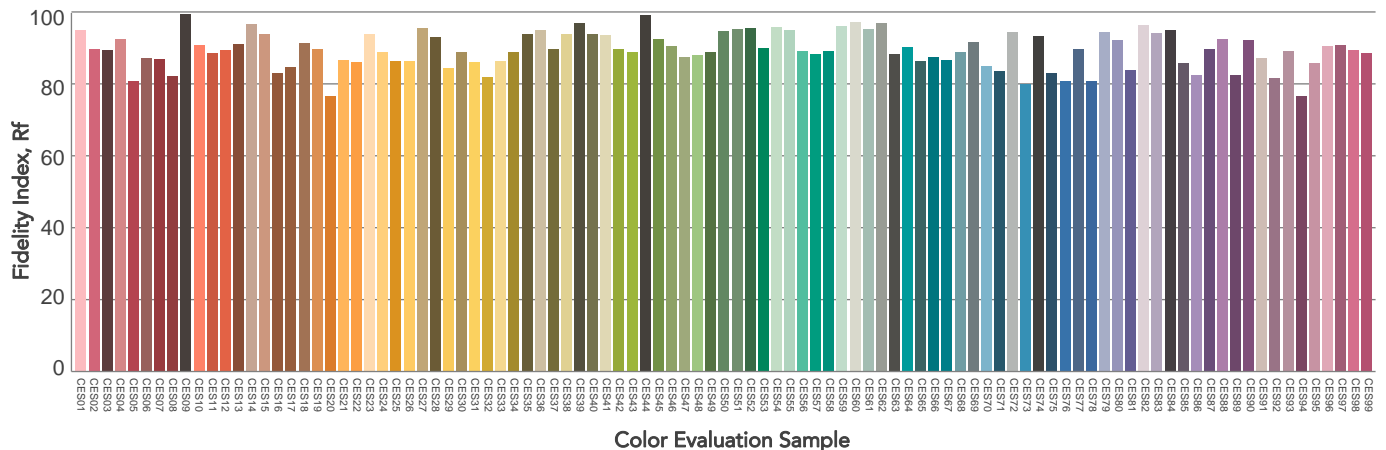
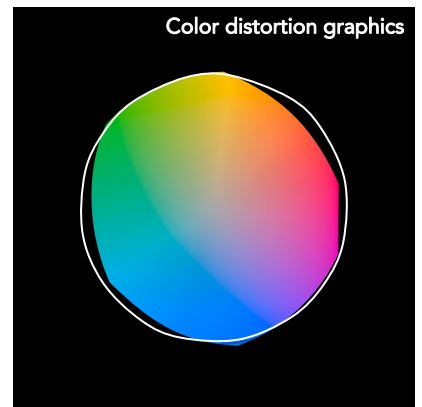
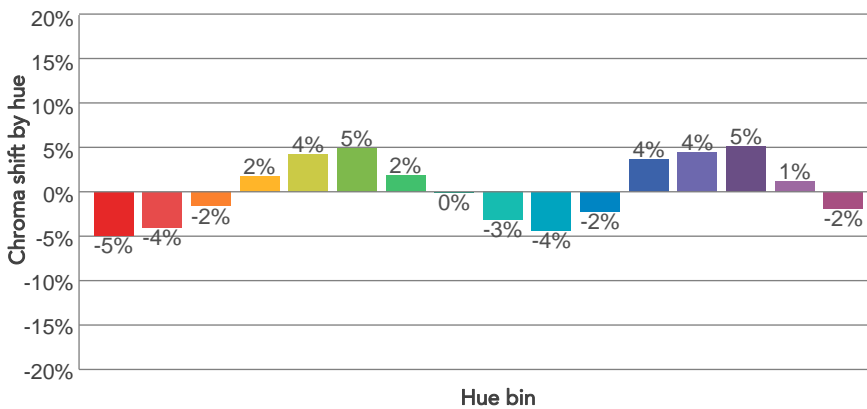
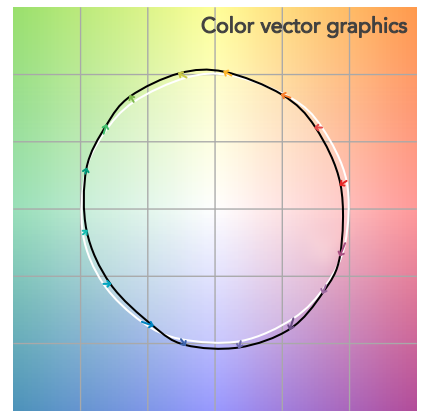
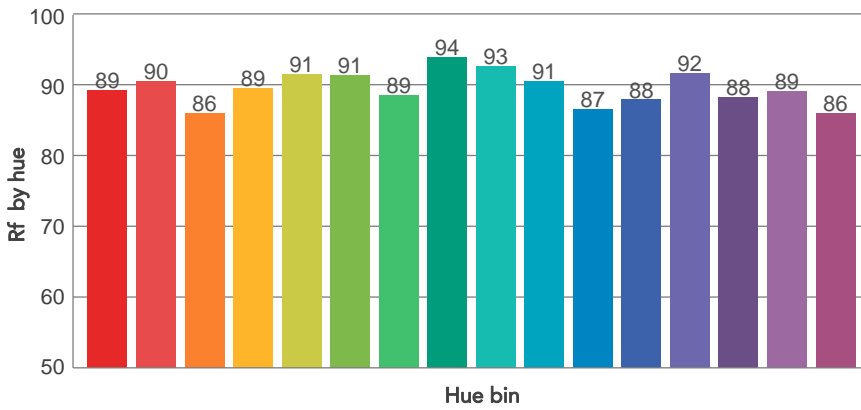
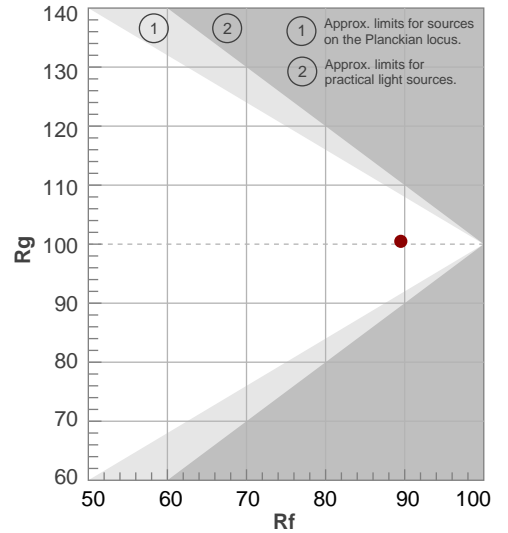

# BEAM DETAILS



Beam angle 50%	Field angle 10%	Cut off angle 2,5%	Intensity ratio in 120° cone	Intensity ratio in 90° cone
24,9°	37,3°	46°	100,0%	99,5%

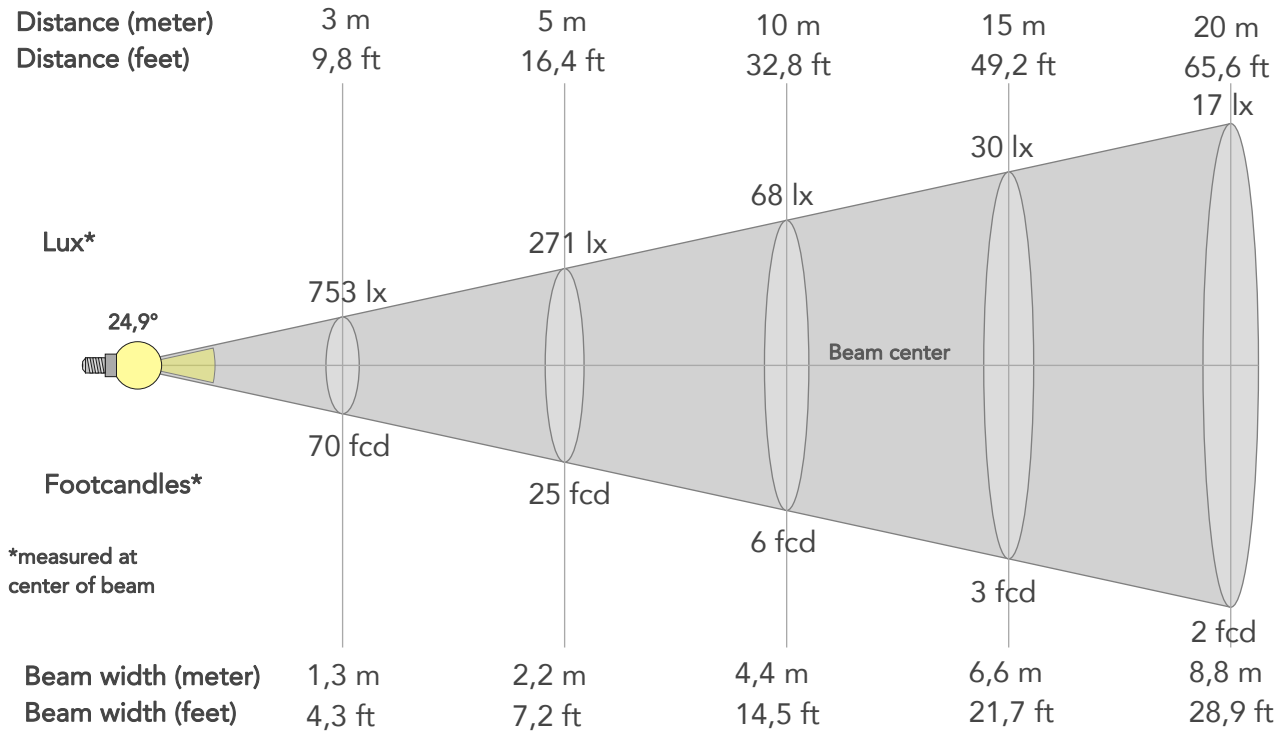

## BEAM INTENSITIES AND WIDTHS

Distance	1m	2m	3m	4m	5m	7,5m	10m	15m	20m	25m	30m	40m	50m
Distance	3,3ft	6,6ft	9,8ft	13,1ft	16,4ft	24,6ft	32,8ft	49,2ft	65,6ft	82ft	98,4ft	131,2ft	164ft
Lux	6780lx	1695lx	753lx	424lx	271lx	121lx	68lx	30lx	17lx	11lx	8lx	4lx	3lx
Footcand.	630fcd	157fcd	70fcd	39fcd	25fcd	11fcd	6fcd	3fcd	2fcd	1fcd	1fcd	0fcd	0fcd
Beam wid.	0,4m	0,9m	1,3m	1,8m	2,2m	3,3m	4,4m	6,6m	8,8m	11m	13,2m	17,6m	22m
Beam wid.	1,5ft	2,9ft	4,3ft	5,8ft	7,2ft	10,8ft	14,5ft	21,7ft	28,9ft	36,1ft	43,4ft	57,8ft	72,3ft

## LINEAR DISTRIBUTION DIAGRAM

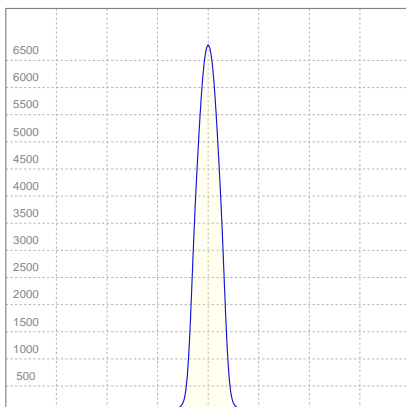

## ELECTRICAL SPECIFICATIONS

Input voltage	Input current	Input power	Effeciency
223V	0,161A	33,6W	35lm/W

Power Fc
0,95

## ISO CANDELA DIAGRAM

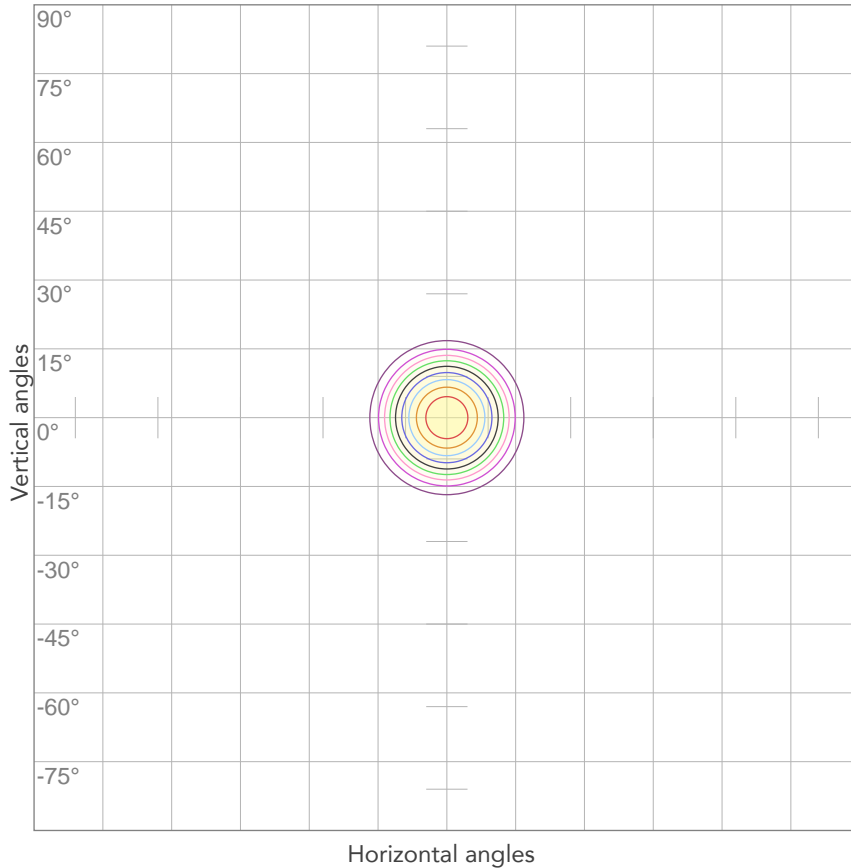

10%	678 cd
20%	1356 cd
30%	2034 cd
40%	2712 cd
50%	3390 cd
60%	4068 cd
70%	4746 cd
80%	5424 cd

Conditions:

Number of c-planes: 2

Candela at center: 6780 cd

## ISO LUX DIAGRAM

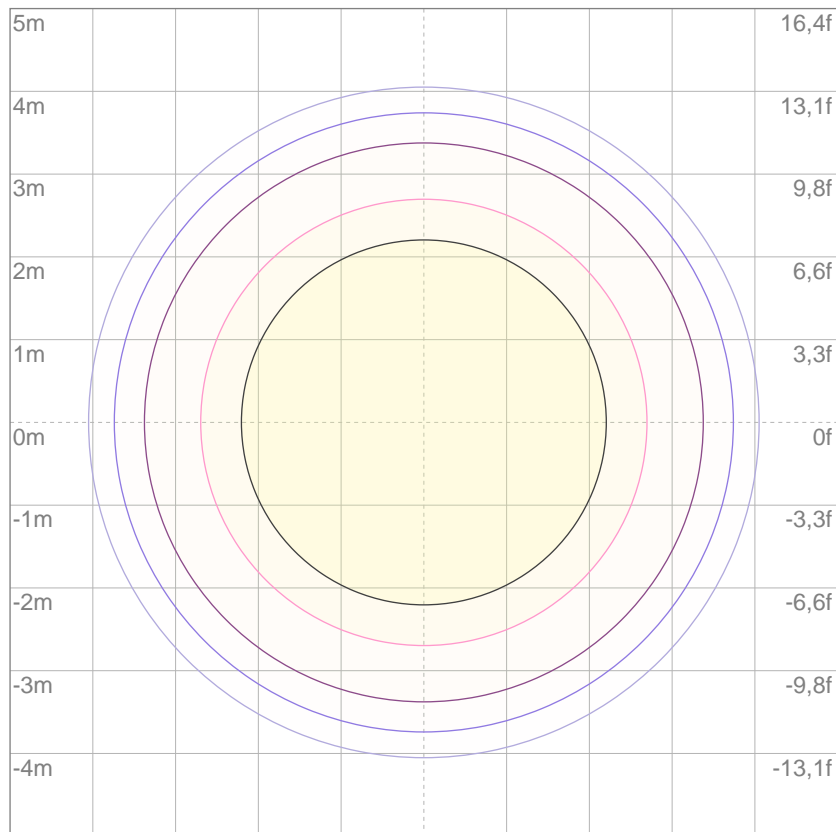

3%	2,03 lx
5%	3,39 lx
10%	6,78 lx
30%	20,3 lx
50%	33,9 lx

Conditions:

Number of c-planes: 2

Lux at center: 67,8 lx

*Lux distribution on a surface when lamp is mounted at 10 meters from the surface.*



Total lumen output:

1849 lm

Peak candela output:

2704 cd

Light quality:

CRI: 89,3

Color temperature:

3045 K

**PRODUCT NAME:**

ECLDISPLAY

**MEASUREMENT CONDITIONS:**

Beam angle:

Wash 25-50 Max Zoom

Target:

3000K

Operator:

Paolo Carvone

Date and time:

19/01/2021 16:50:45

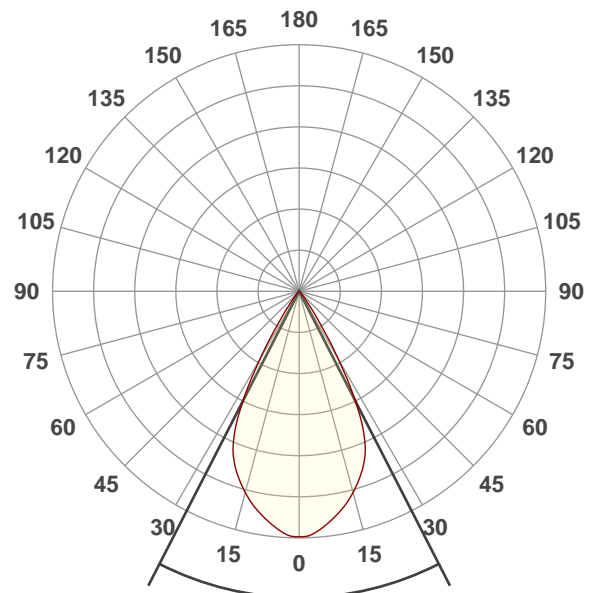

Beam angle 50%: 54,3°

Field angle 10%: 69,9°

Cut off angle 2.5%: 81,3°

Spectra

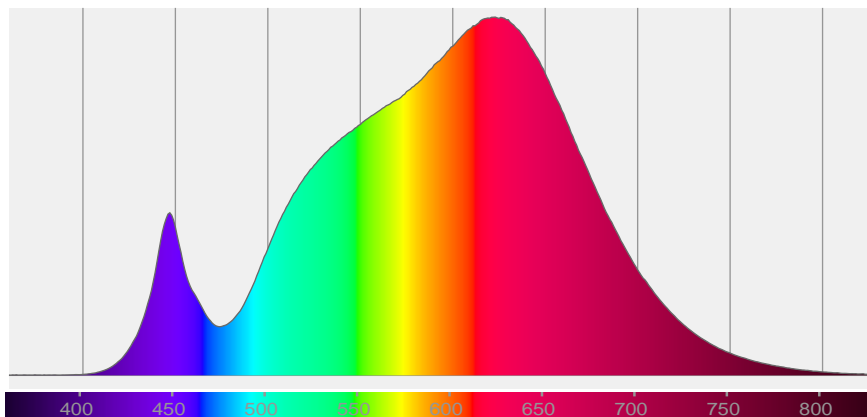

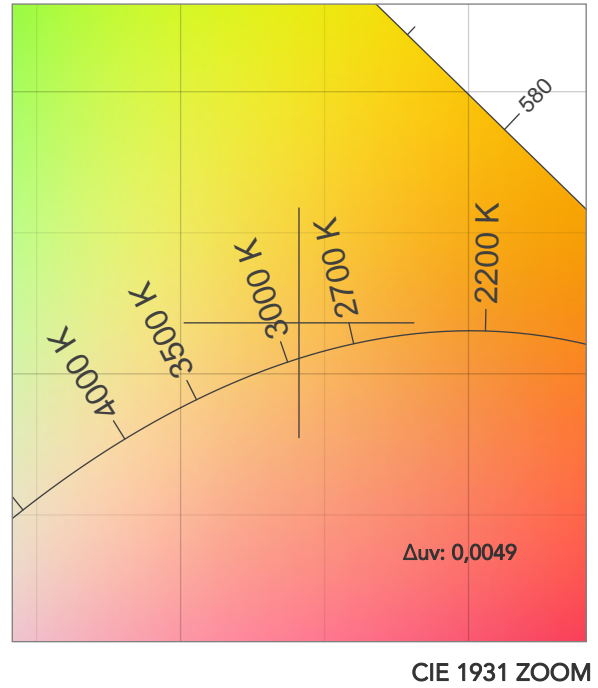
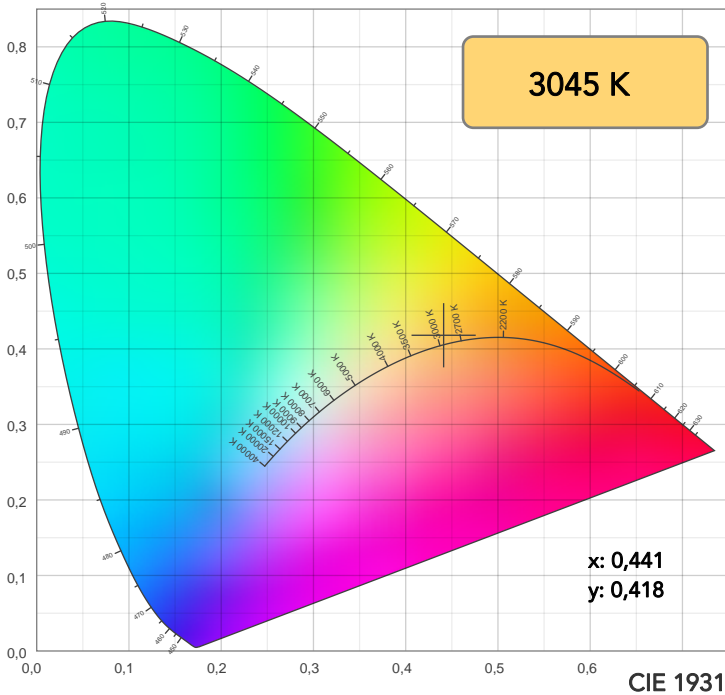

TM30: 89,2

CRI: 89,3 (R1-R8)

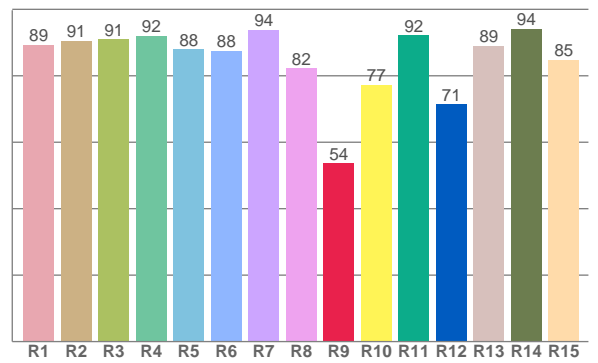
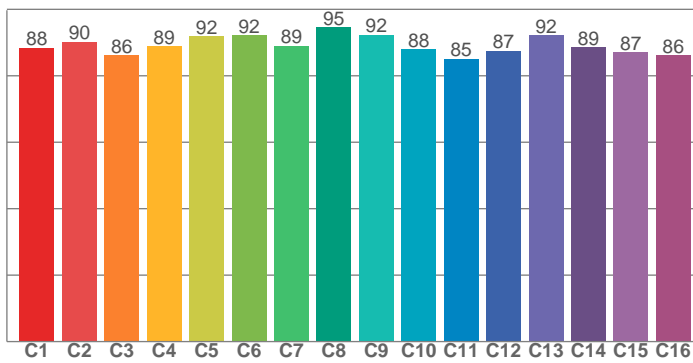

CRI R values, only R1-R8 are used to calculate final CRI value

R1	R2	R3	R4	R5	R6	R7	R8	R9	R10	R11	R12	R13	R14	R15
89,4	90,5	91,0	92,0	88,0	87,6	93,9	82,3	53,7	77,3	92,2	71,4	89,1	94,2	84,8

TM30 C values, 16 binned values out of total of 99 C values

C1	C2	C3	C4	C5	C6	C7	C8	C9	C10	C11	C12	C13	C14	C15	C16
88,4	90,1	86,2	88,9	91,9	92,1	89,0	94,6	92,4	88,0	85,1	87,4	92,1	88,5	87,0	86,2

CQS Q values

Q1	Q2	Q3	Q4	Q5	Q6	Q7	Q8	Q9	Q10	Q11	Q12	Q13	Q14	Q15
86,9	97,1	87,3	87,7	88,2	86,9	89,9	94,3	95,5	91,5	89,3	90,5	91,4	84,2	85,4

CQS: 89,0

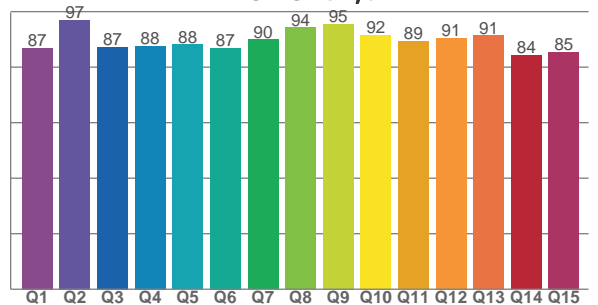

COLOR PARAMETERS

Color temperature	Color rendering index	Red component	Color fidelity	Color gamut	Color quality scale	Television lighting index	Color coordinate cie 1931	Color coordinate cie 1931	Color deviation from black body
CCT	CRI	CRI R9	TM30 Rf	TM30 Rg	CQS	TLCI	x	y	Δuv
3045 K	89,3	53,7	89,2	99,8	89,0	88	0,441	0,418	0,0049

# TM30 DETAILS

**Rf 89,2**  
Fidelity index Rf

**Rg 99,8**  
Gammut index

Hue Bin	R <sub>f</sub>	Graphic shifts (%)	
		Chroma	Hue
1	88	-5%	-2%
2	90	-4%	2%
3	86	-2%	6%
4	89	1%	6%
5	92	3%	5%
6	92	4%	0%
7	89	1%	-6%
8	95	0%	-3%
9	92	-4%	-2%
10	88	-5%	3%
11	85	-3%	9%
12	87	3%	5%
13	92	4%	-1%
14	89	5%	-6%
15	87	1%	-7%
16	86	-1%	-10%

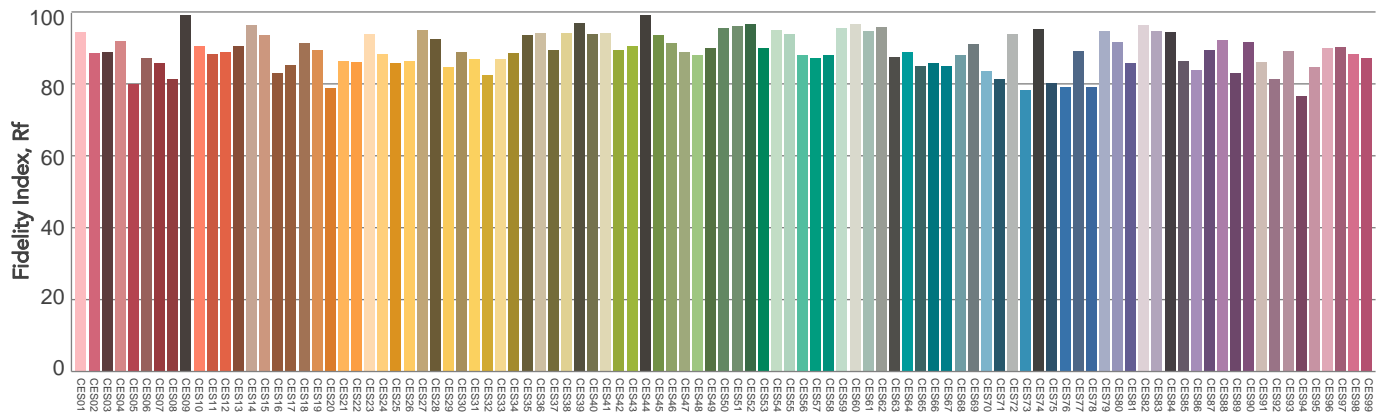
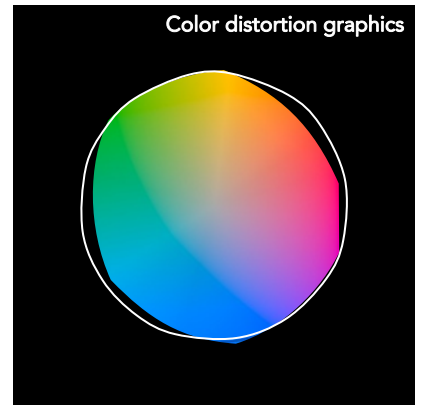
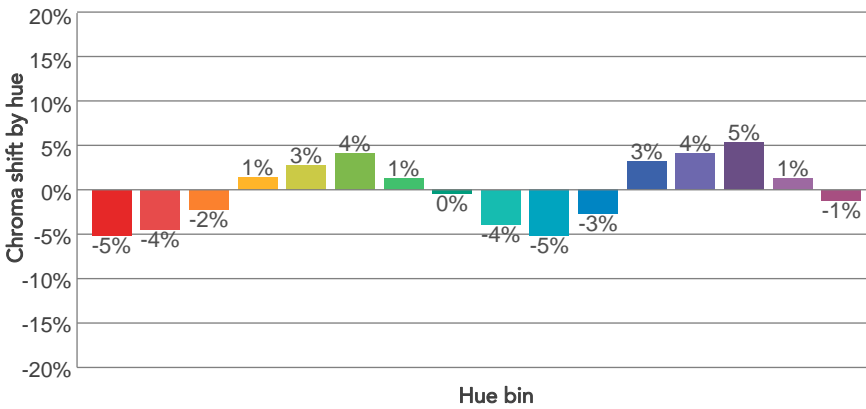
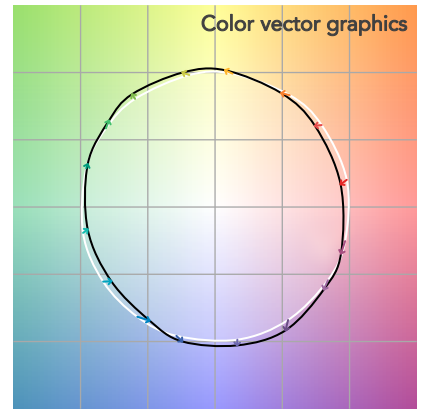
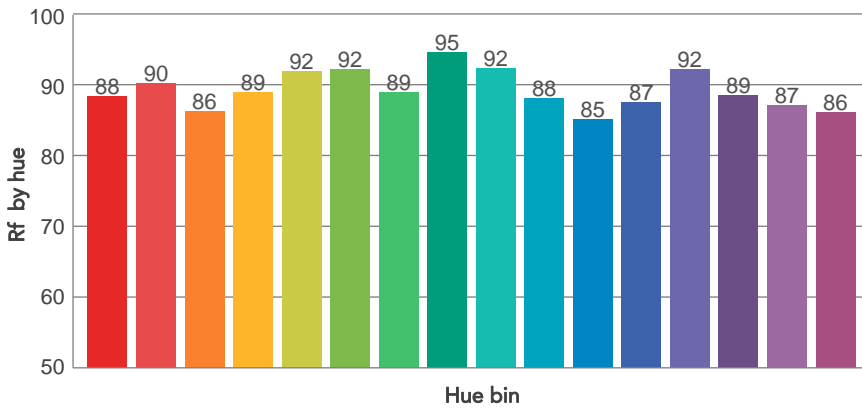
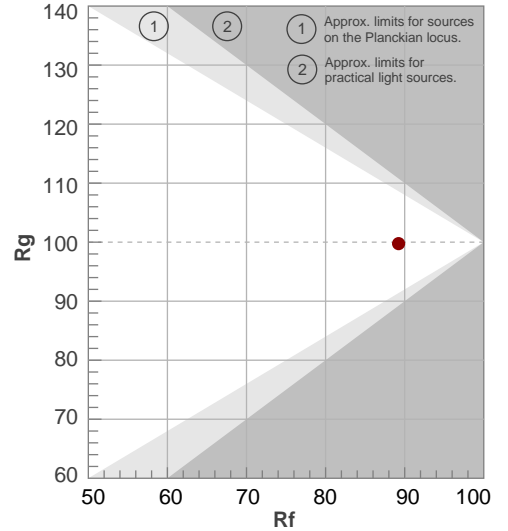



# BEAM DETAILS



Beam angle 50%	Field angle 10%	Cut off angle 2,5%	Intensity ratio in 120° cone	Intensity ratio in 90° cone
54,3°	69,9°	81,3°	99,8%	98,7%

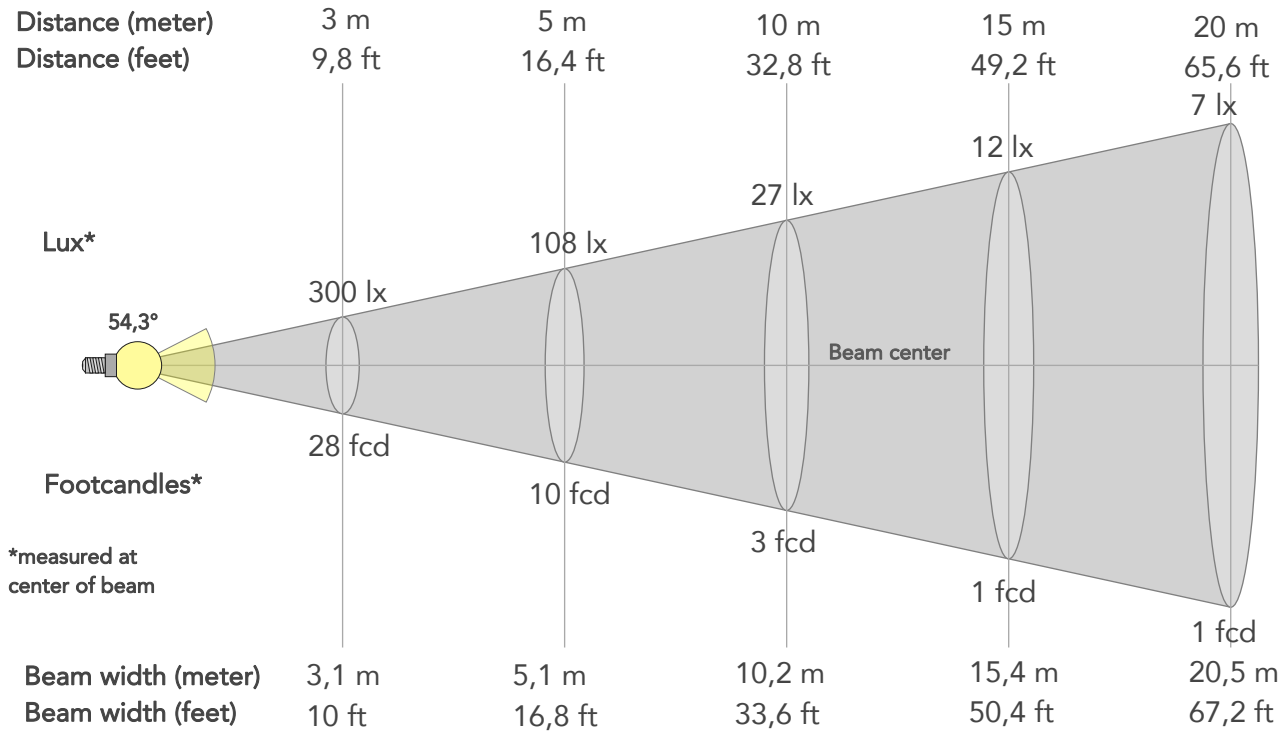

## BEAM INTENSITIES AND WIDTHS

Distance	1m	2m	3m	4m	5m	7,5m	10m	15m	20m	25m	30m	40m	50m
Distance	3,3ft	6,6ft	9,8ft	13,1ft	16,4ft	24,6ft	32,8ft	49,2ft	65,6ft	82ft	98,4ft	131,2ft	164ft
Lux	2704lx	676lx	300lx	169lx	108lx	48lx	27lx	12lx	7lx	4lx	3lx	2lx	1lx
Footcand.	251fcd	63fcd	28fcd	16fcd	10fcd	4fcd	3fcd	1fcd	1fcd	0fcd	0fcd	0fcd	0fcd
Beam wid.	1m	2m	3,1m	4,1m	5,1m	7,7m	10,2m	15,4m	20,5m	25,6m	30,7m	41m	51,2m
Beam wid.	3,4ft	6,8ft	10ft	13,4ft	16,8ft	25,2ft	33,6ft	50,4ft	67,2ft	84ft	100,8ft	134,4ft	168ft

## LINEAR DISTRIBUTION DIAGRAM

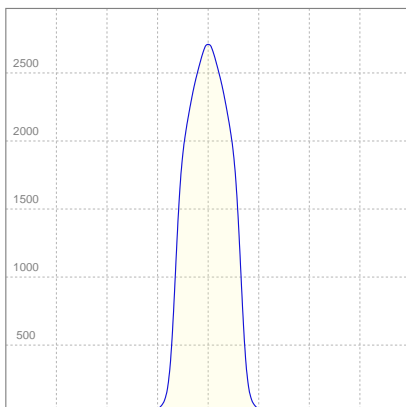

## ELECTRICAL SPECIFICATIONS

Input voltage	Input current	Input power	Effeciency
222V	0,163A	33,9W	54lm/W

Power Fc
0,95

## ISO CANDELA DIAGRAM

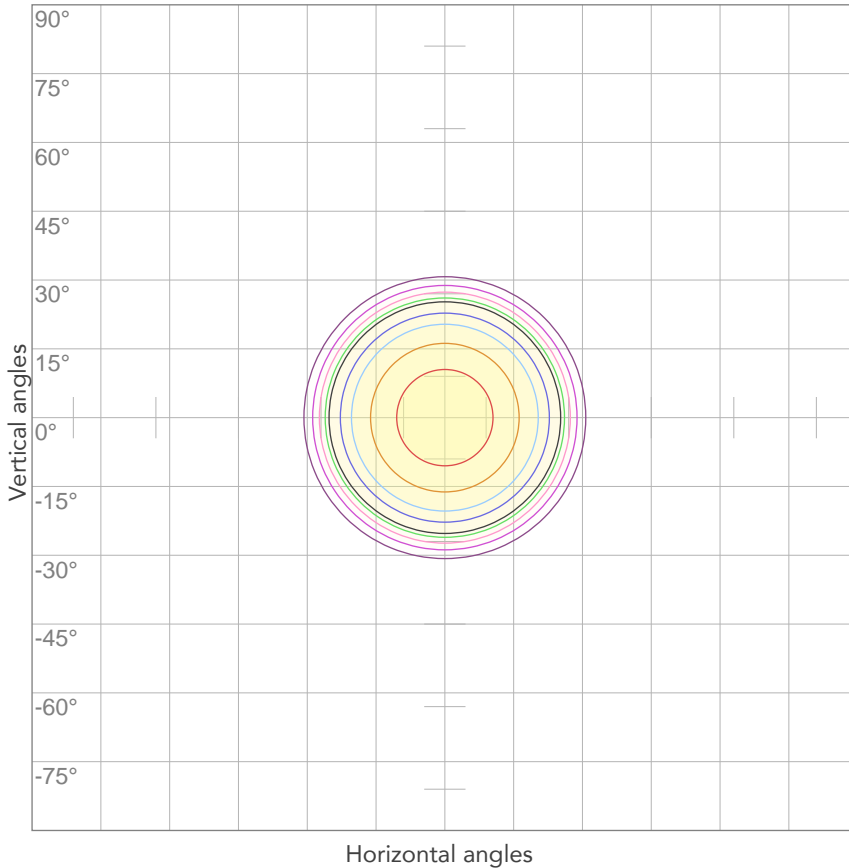

10%	270 cd
20%	541 cd
30%	811 cd
40%	1081 cd
50%	1352 cd
60%	1622 cd
70%	1893 cd
80%	2163 cd

Conditions:

Number of c-planes: 2

Candela at center: 2704 cd

## ISO LUX DIAGRAM

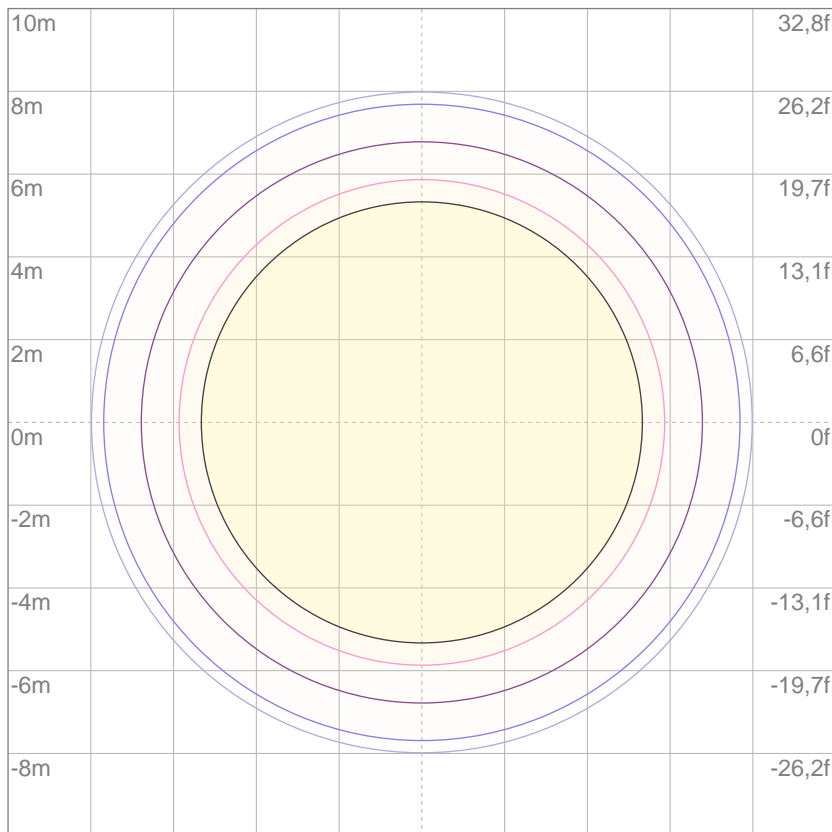

3%	0,811 lx
5%	1,35 lx
10%	2,70 lx
30%	8,11 lx
50%	13,5 lx

Conditions:

Number of c-planes: 2

Lux at center: 27,0 lx

*Lux distribution on a surface when lamp is mounted at 10 meters from the surface.*

Mounting height: 10 meters (33 feet)



Total lumen output:

1311 lm

Peak candela output:

7742 cd

Light quality:

CRI: 89,5

Color temperature:

3028 K

**PRODUCT NAME:**

ECLDISPLAY

**MEASURAMENT CONDITIONS:**

Beam angle:

Wash 25-50 Min Zoom

Target:

3000K

Operator:

Paolo Carvone

Date and time:

19/01/2021 16:52:07

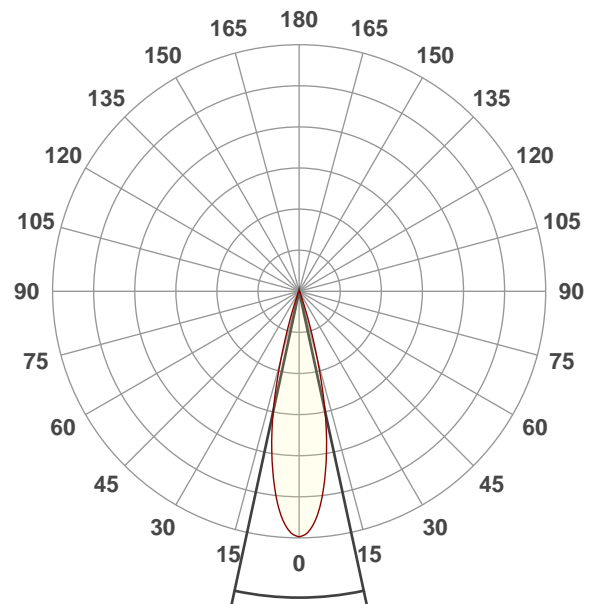

Beam angle 50%: 24,4°

Field angle 10%: 36,8°

Cut off angle 2.5%: 45,3°

Spectra

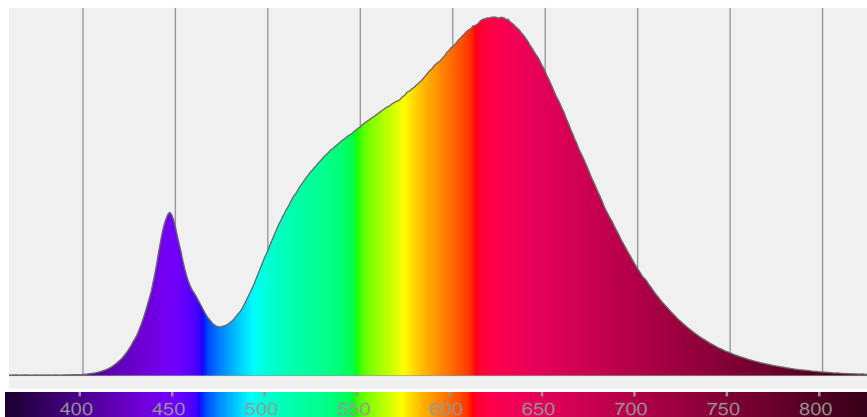

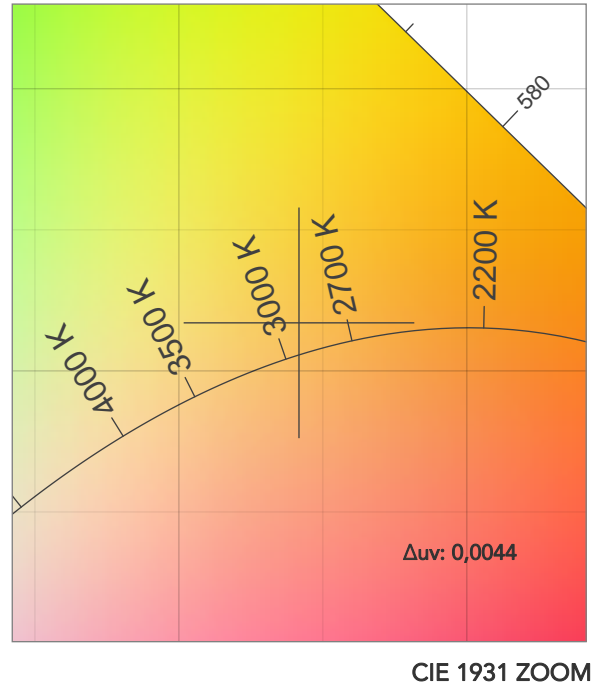
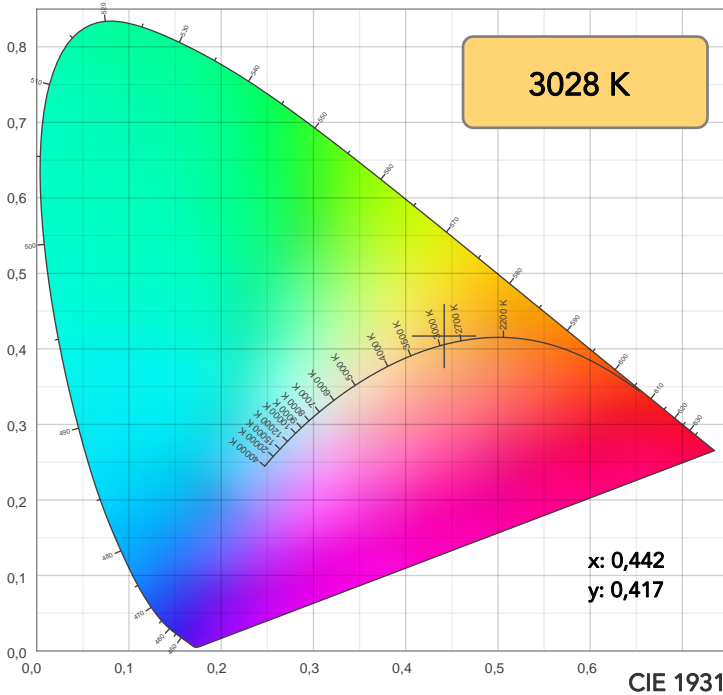

TM30: 89,1

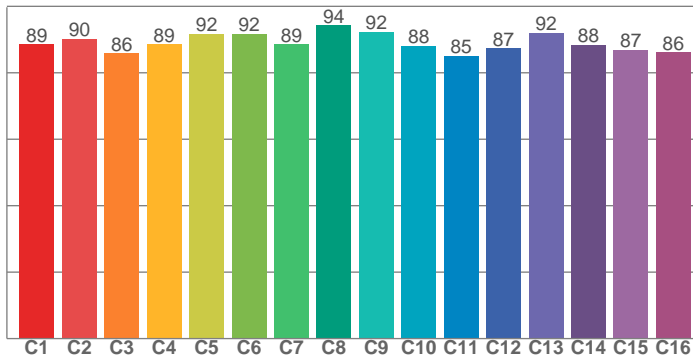

CRI: 89,5 (R1-R8)

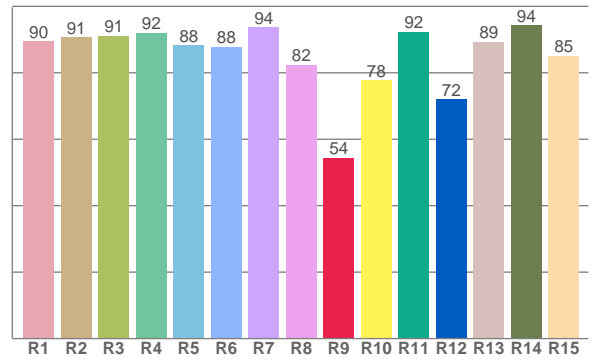

CQS: 89,0

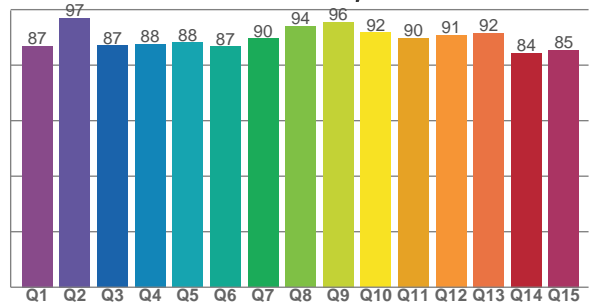

CRI R values, only R1-R8 are used to calculate final CRI value

R1	R2	R3	R4	R5	R6	R7	R8	R9	R10	R11	R12	R13	R14	R15
89,6	90,8	91,1	92,0	88,2	87,9	93,8	82,4	54,4	77,8	92,3	72,0	89,3	94,2	85,2

TM30 C values, 16 binned values out of total of 99 C values

C1	C2	C3	C4	C5	C6	C7	C8	C9	C10	C11	C12	C13	C14	C15	C16
88,5	90,1	85,9	88,6	91,7	91,7	88,6	94,2	92,3	88,1	85,1	87,3	92,0	88,5	87,0	86,2

CQS Q values

Q1	Q2	Q3	Q4	Q5	Q6	Q7	Q8	Q9	Q10	Q11	Q12	Q13	Q14	Q15
86,8	97,1	87,1	87,6	88,1	86,7	89,6	94,0	95,5	91,7	89,8	90,8	91,5	84,5	85,4

COLOR PARAMETERS

Color temperature	Color rendering index	Red component	Color fidelity	Color gamut	Color quality scale	Television lighting index	Color coordinate cie 1931	Color coordinate cie 1931	Color deviation from black body
CCT	CRI	CRI R9	TM30 Rf	TM30 Rg	CQS	TLCI	x	y	Δuv
3028 K	89,5	54,4	89,1	100,0	89,0	88	0,442	0,417	0,0044

# TM30 DETAILS

**Rf 89,1**  
Fidelity index Rf

**Rg 100,0**  
Gammut index

Hue Bin	R <sub>f</sub>	Graphic shifts (%)	
		Chroma	Hue
1	89	-5%	-2%
2	90	-4%	2%
3	86	-2%	6%
4	89	2%	6%
5	92	3%	5%
6	92	4%	0%
7	89	2%	-6%
8	94	0%	-3%
9	92	-4%	-2%
10	88	-5%	3%
11	85	-3%	9%
12	87	3%	5%
13	92	4%	-1%
14	88	5%	-6%
15	87	1%	-7%
16	86	-1%	-10%

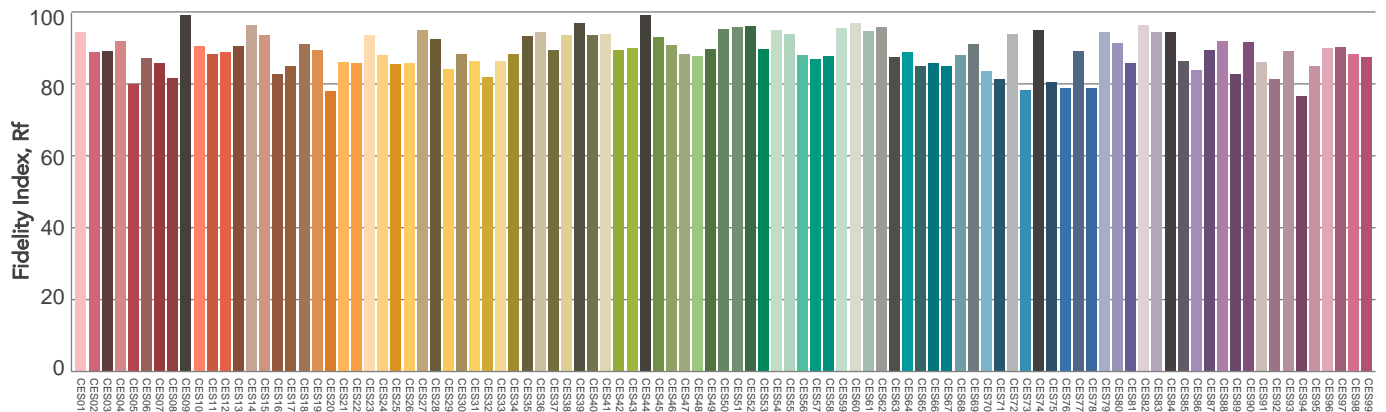
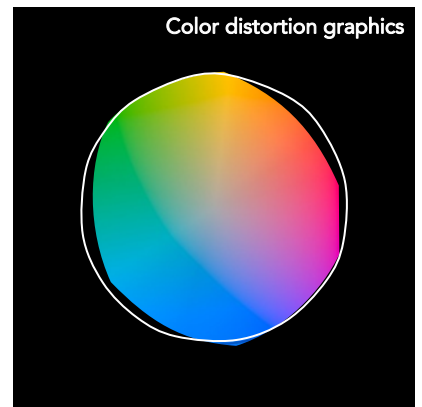
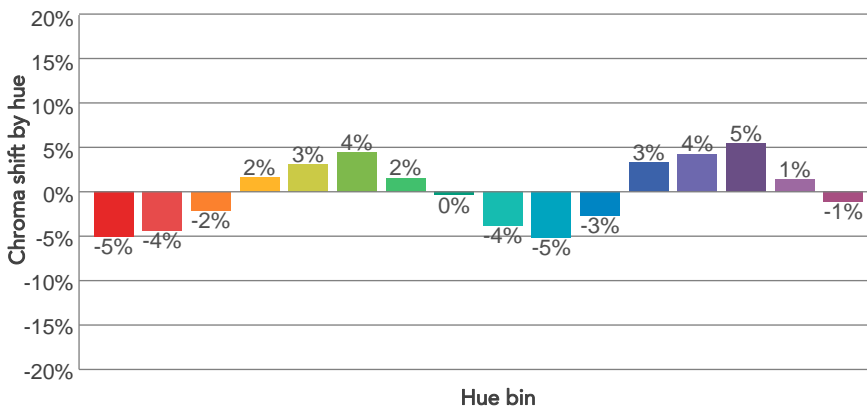
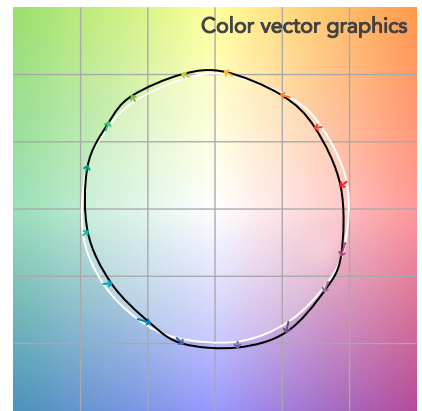
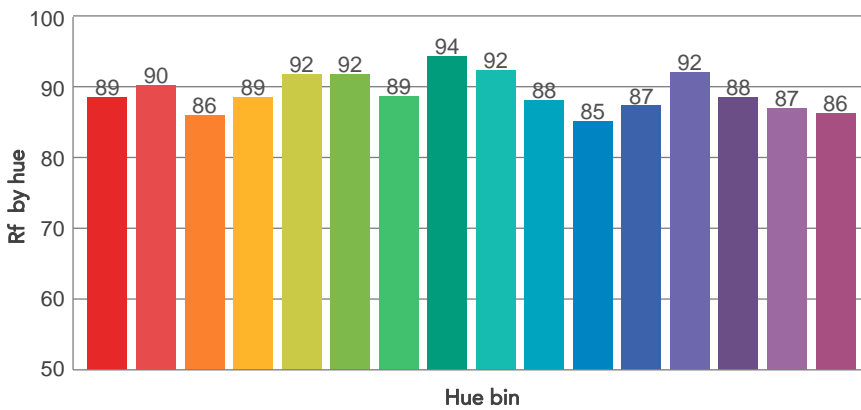
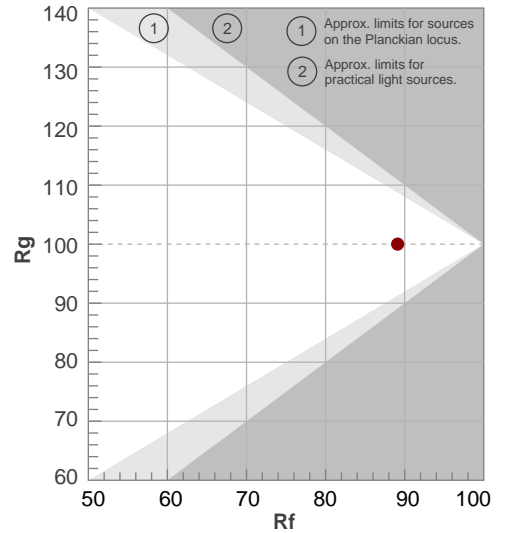

Color Evaluation Sample

# BEAM DETAILS



Beam angle 50%	Field angle 10%	Cut off angle 2,5%	Intensity ratio in 120° cone	Intensity ratio in 90° cone
24,4°	36,8°	45,3°	100,0%	99,5%

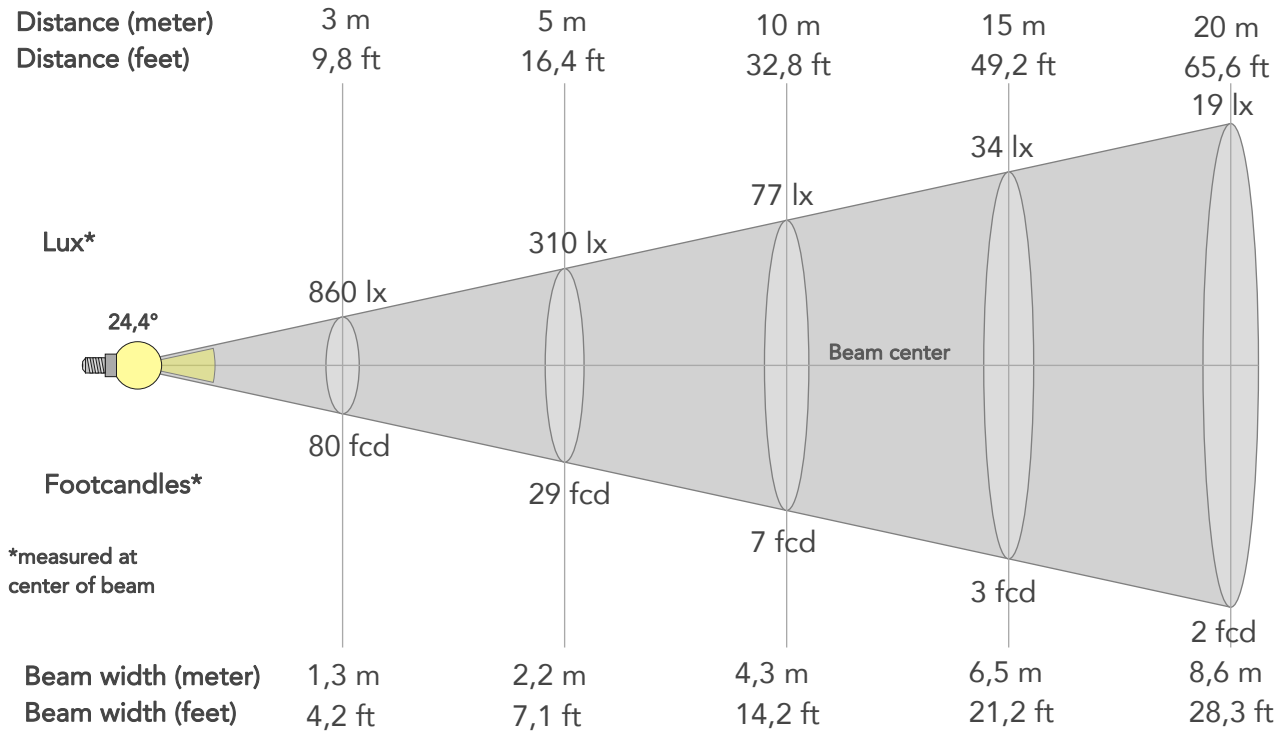

## BEAM INTENSITIES AND WIDTHS

Distance	1m	2m	3m	4m	5m	7,5m	10m	15m	20m	25m	30m	40m	50m
Distance	3,3ft	6,6ft	9,8ft	13,1ft	16,4ft	24,6ft	32,8ft	49,2ft	65,6ft	82ft	98,4ft	131,2ft	164ft
Lux	7742lx	1935lx	860lx	484lx	310lx	138lx	77lx	34lx	19lx	12lx	9lx	5lx	3lx
Footcand.	719fcd	180fcd	80fcd	45fcd	29fcd	13fcd	7fcd	3fcd	2fcd	1fcd	1fcd	0fcd	0fcd
Beam wid.	0,4m	0,9m	1,3m	1,7m	2,2m	3,2m	4,3m	6,5m	8,6m	10,8m	12,9m	17,3m	21,6m
Beam wid.	1,4ft	2,8ft	4,2ft	5,7ft	7,1ft	10,6ft	14,2ft	21,2ft	28,3ft	35,4ft	42,5ft	56,6ft	70,8ft

## LINEAR DISTRIBUTION DIAGRAM

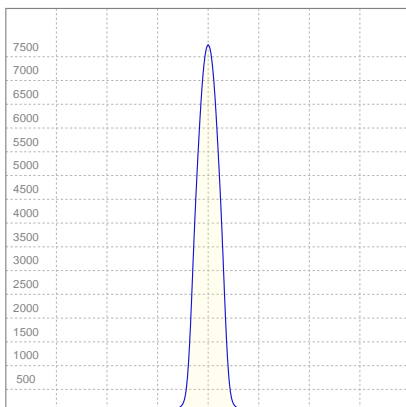

## ELECTRICAL SPECIFICATIONS

Input voltage	Input current	Input power	Effeciency
221V	0,163A	33,8W	39lm/W

Power Fc
0,95

## ISO CANDELA DIAGRAM

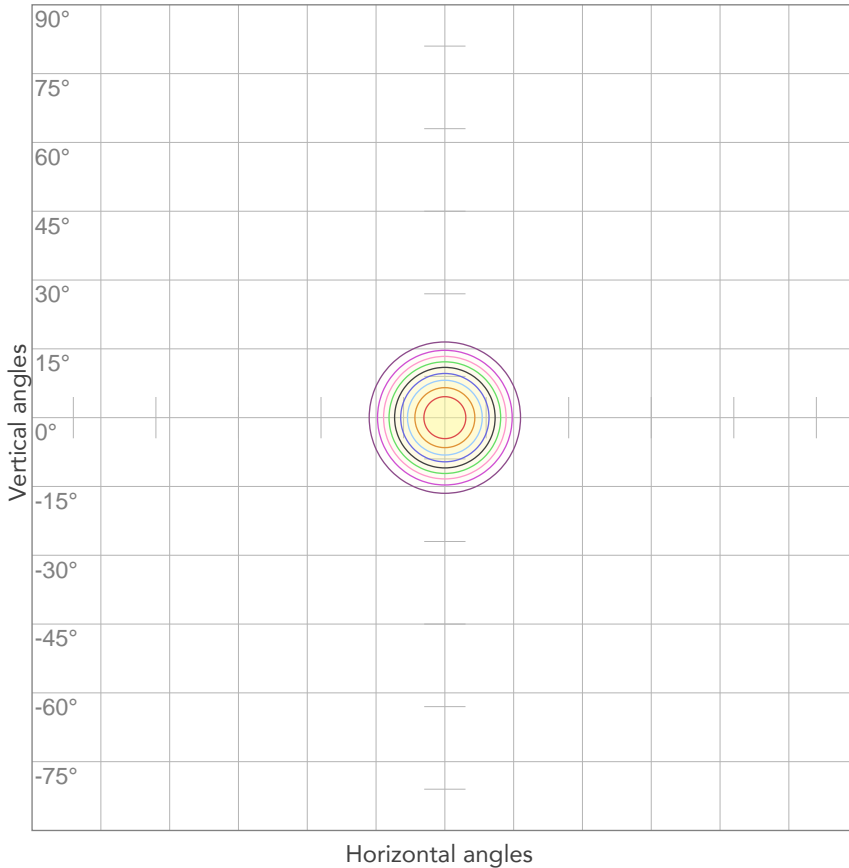

10%	774 cd
20%	1548 cd
30%	2323 cd
40%	3097 cd
50%	3871 cd
60%	4645 cd
70%	5419 cd
80%	6194 cd

**Conditions:**

Number of c-planes: 2

Candela at center: 7742 cd

## ISO LUX DIAGRAM

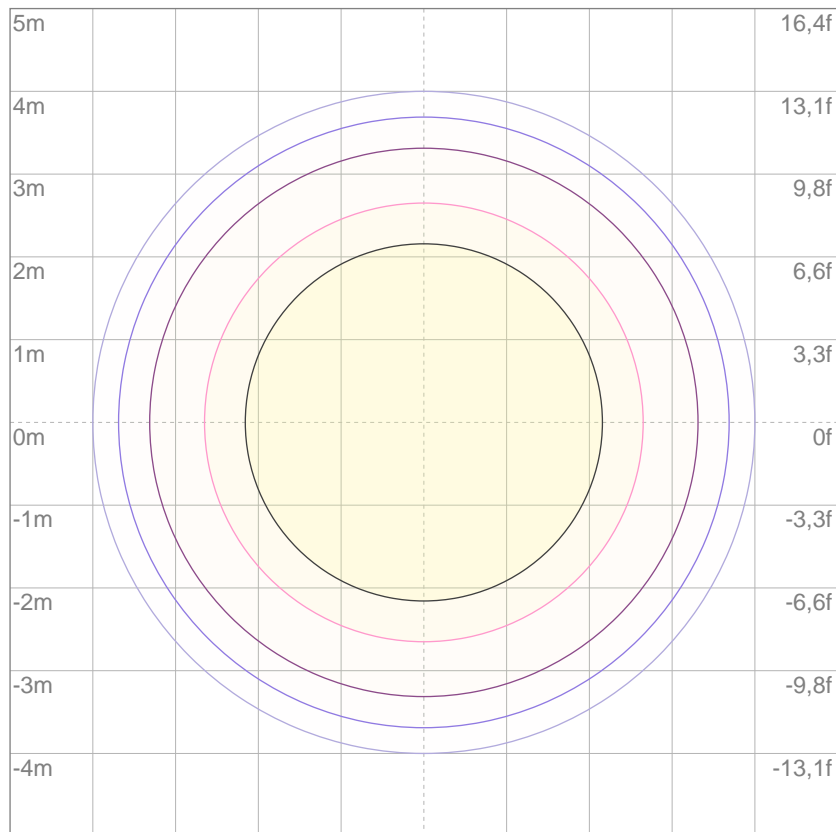

3%	2,32 lx
5%	3,87 lx
10%	7,74 lx
30%	23,2 lx
50%	38,7 lx

**Conditions:**

Number of c-planes: 2

Lux at center: 77,4 lx

*Lux distribution on a surface when lamp is mounted at 10 meters from the surface.*

Mounting height: 10 meters (33 feet)



Total lumen output:

1845 lm

Peak candela output:

2663 cd

Light quality:

CRI: 93,1

Color temperature:

3989 K

**PRODUCT NAME:**  
ECLDISPLAY

**MEASUREMENT CONDITIONS:**

Beam angle:  
Wash 25-50 Max Zoom

Target:  
4000K

Operator:  
Paolo Carvone

Date and time:  
19/01/2021 17:33:19

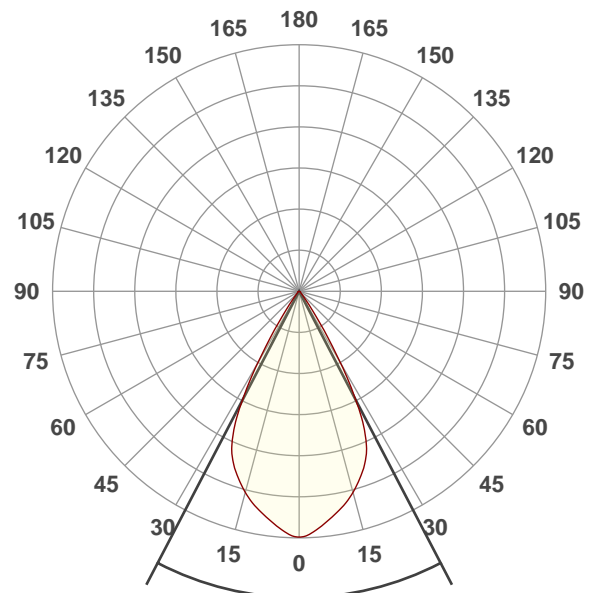

Beam angle 50%: 55°  
Field angle 10%: 69,5°  
Cut off angle 2.5%: 80,8°

Spectra

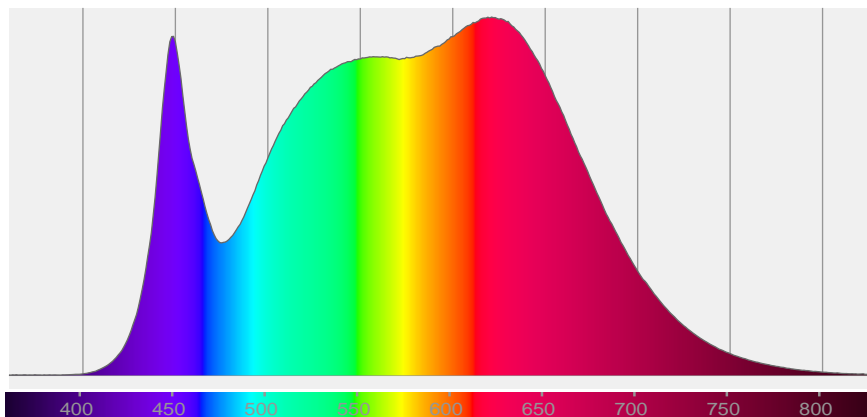



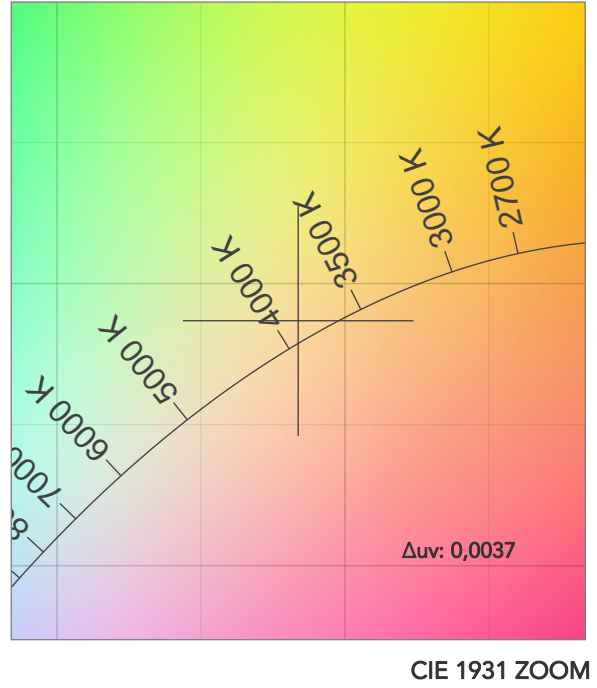
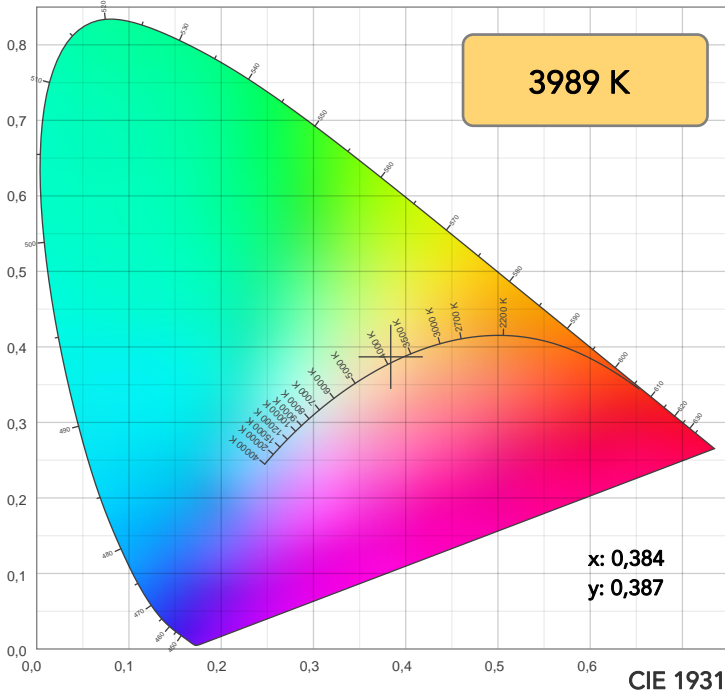

TM30: 91,7

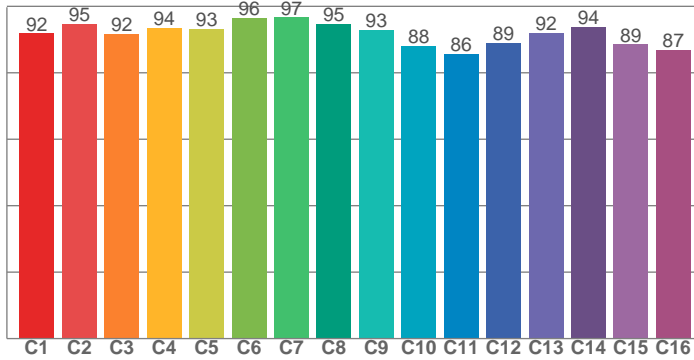

CRI: 93,1 (R1-R8)

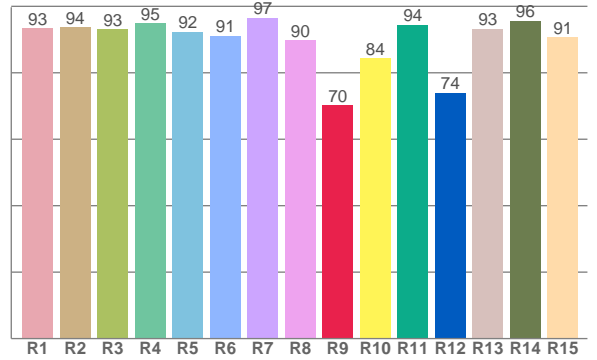

CRI R values, only R1-R8 are used to calculate final CRI value

R1	R2	R3	R4	R5	R6	R7	R8	R9	R10	R11	R12	R13	R14	R15
93,5	93,8	93,0	94,8	92,3	91,2	96,6	89,7	70,2	84,4	94,4	74,0	93,3	95,7	90,8

TM30 C values, 16 binned values out of total of 99 C values

C1	C2	C3	C4	C5	C6	C7	C8	C9	C10	C11	C12	C13	C14	C15	C16
91,9	94,8	91,7	93,6	93,2	96,5	96,6	94,8	92,9	88,1	85,6	88,9	92,0	93,9	88,5	87,0

CQS Q values

Q1	Q2	Q3	Q4	Q5	Q6	Q7	Q8	Q9	Q10	Q11	Q12	Q13	Q14	Q15
93,5	99,0	88,8	89,5	93,0	93,6	94,4	97,0	97,7	95,1	95,3	96,0	96,4	91,6	92,4

CQS: 93,6

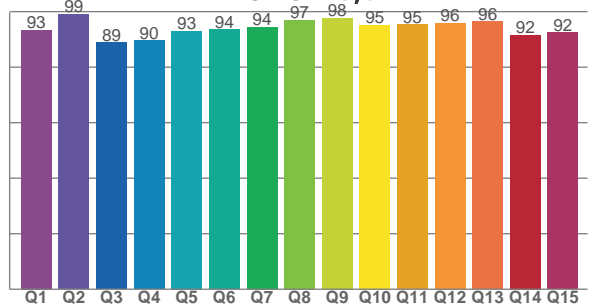

COLOR PARAMETERS

Color temperature	Color rendering index	Red component	Color fidelity	Color gamut	Color quality scale	Television lighting index	Color coordinate cie 1931	Color coordinate cie 1931	Color deviation from black body
CCT	CRI	CRI R9	TM30 Rf	TM30 Rg	CQS	TLCI	x	y	$\Delta uv$
3989 K	93,1	70,2	91,7	99,5	93,6	95	0,384	0,387	0,0037

# TM30 DETAILS

**Rf 91,7**  
Fidelity index Rf

**Rg 99,5**  
Gammut index

Hue Bin	R <sub>f</sub>	Graphic shifts (%)	
		Chroma	Hue
1	92	-4%	-1%
2	95	-2%	1%
3	92	-2%	3%
4	94	-1%	2%
5	93	-1%	2%
6	96	1%	0%
7	97	-1%	-1%
8	95	-2%	0%
9	93	-3%	3%
10	88	-3%	6%
11	86	2%	9%
12	89	3%	4%
13	92	4%	-2%
14	94	4%	-2%
15	89	2%	-7%
16	87	0%	-7%

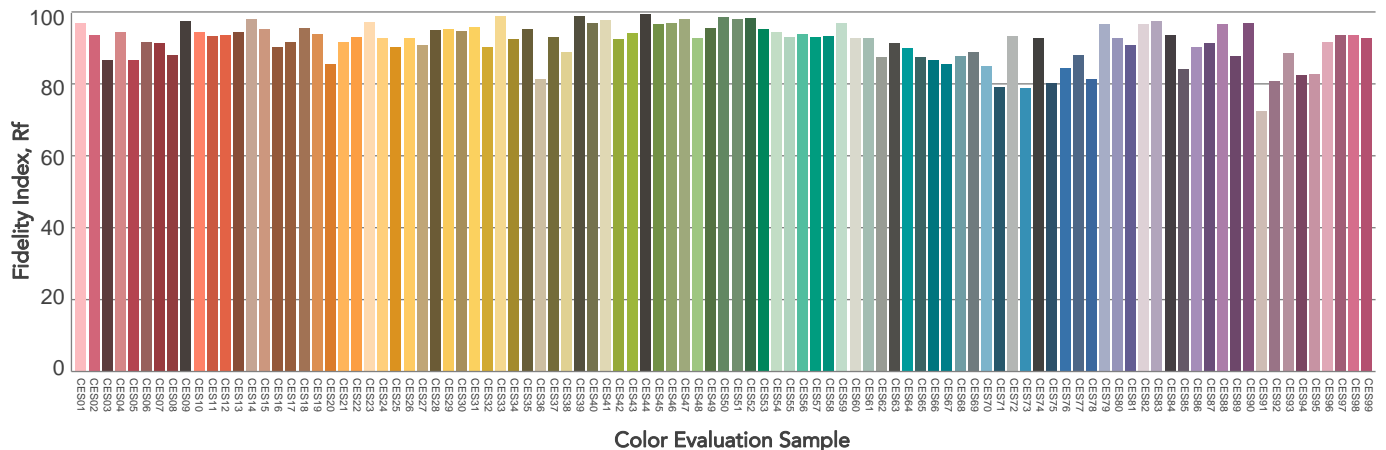
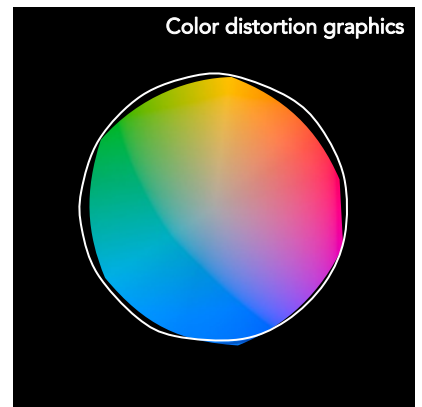
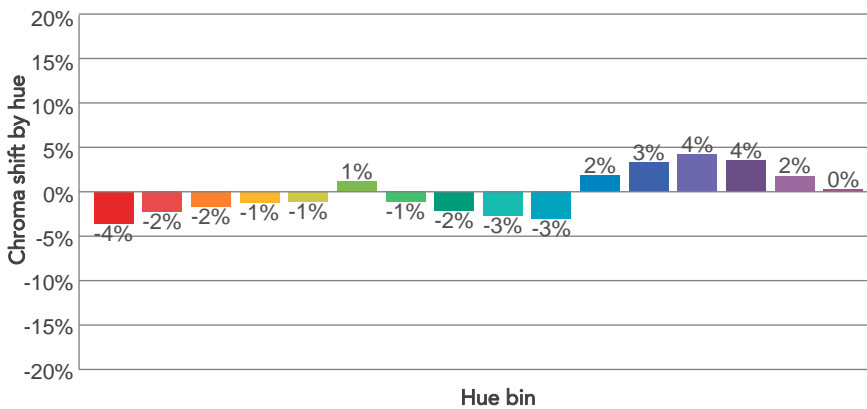
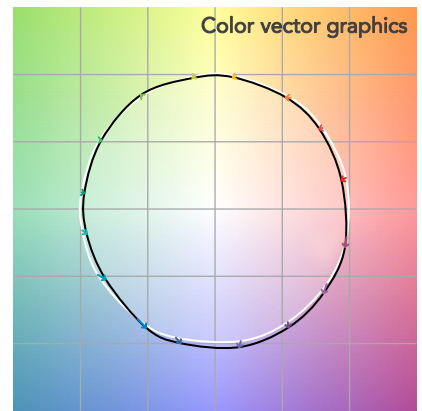
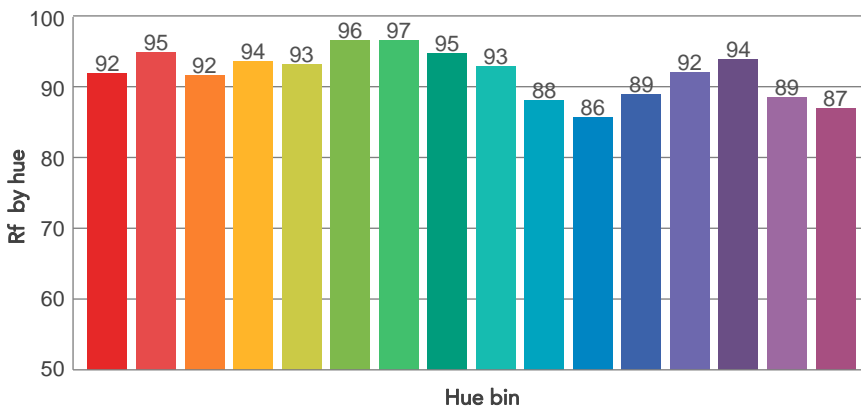
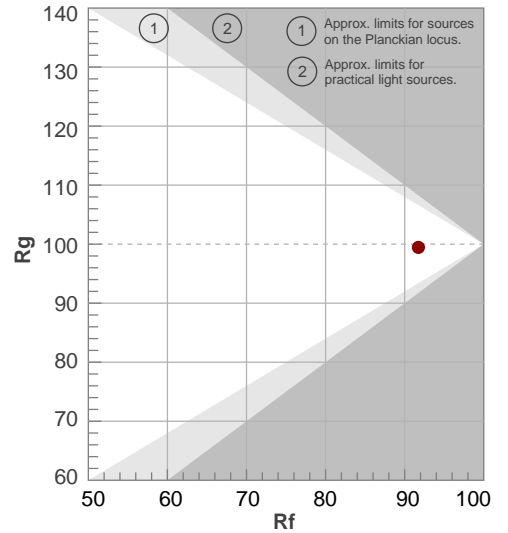

# BEAM DETAILS



Beam angle 50%	Field angle 10%	Cut off angle 2,5%	Intensity ratio in 120° cone	Intensity ratio in 90° cone
55°	69,5°	80,8°	99,8%	98,7%

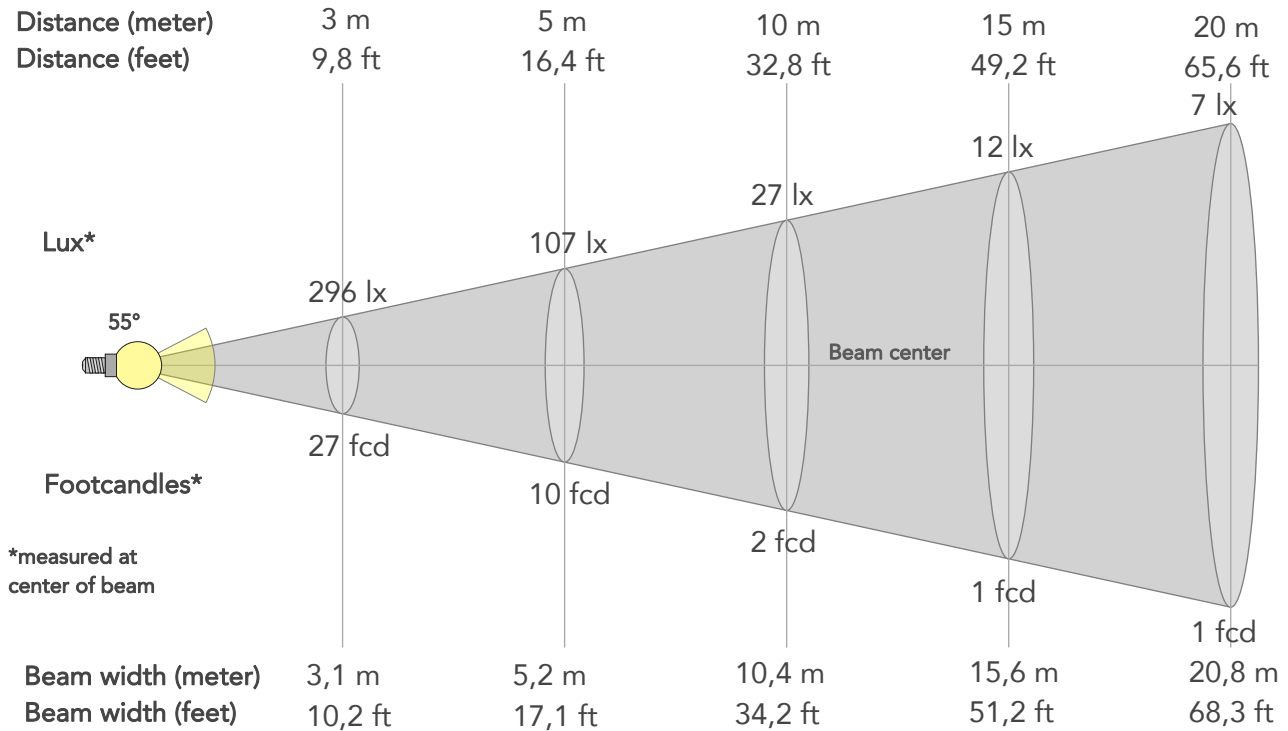

## BEAM INTENSITIES AND WIDTHS

Distance	1m	2m	3m	4m	5m	7,5m	10m	15m	20m	25m	30m	40m	50m
Distance	3,3ft	6,6ft	9,8ft	13,1ft	16,4ft	24,6ft	32,8ft	49,2ft	65,6ft	82ft	98,4ft	131,2ft	164ft
Lux	2663lx	666lx	296lx	166lx	107lx	47lx	27lx	12lx	7lx	4lx	3lx	2lx	1lx
Footcand.	247fcd	62fcd	27fcd	15fcd	10fcd	4fcd	2fcd	1fcd	1fcd	0fcd	0fcd	0fcd	0fcd
Beam wid.	1m	2,1m	3,1m	4,2m	5,2m	7,8m	10,4m	15,6m	20,8m	26m	31,2m	41,7m	52,1m
Beam wid.	3,4ft	6,9ft	10,2ft	13,6ft	17,1ft	25,6ft	34,2ft	51,2ft	68,3ft	85,4ft	102,5ft	136,6ft	170,8ft

## LINEAR DISTRIBUTION DIAGRAM

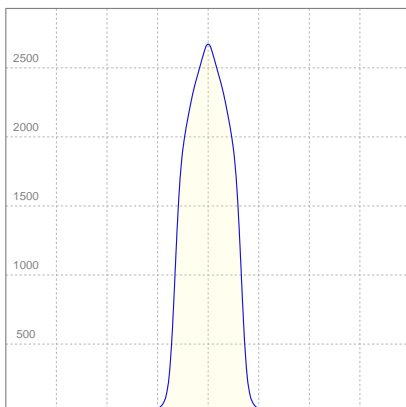

## ELECTRICAL SPECIFICATIONS

Input voltage	Input current	Input power	Effeciency
222V	0,161A	33,6W	55lm/W

Power Fc
0,95

## ISO CANDELA DIAGRAM

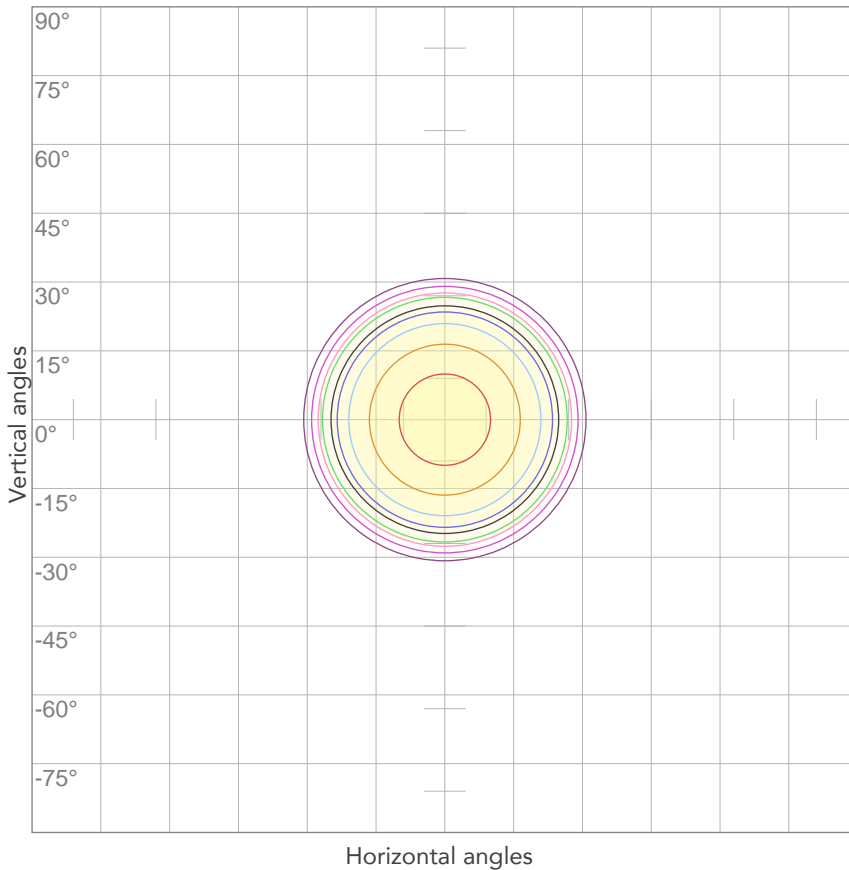

10%	266 cd
20%	533 cd
30%	799 cd
40%	1065 cd
50%	1332 cd
60%	1598 cd
70%	1864 cd
80%	2131 cd

Conditions:

Number of c-planes: 2

Candela at center: 2663 cd

## ISO LUX DIAGRAM

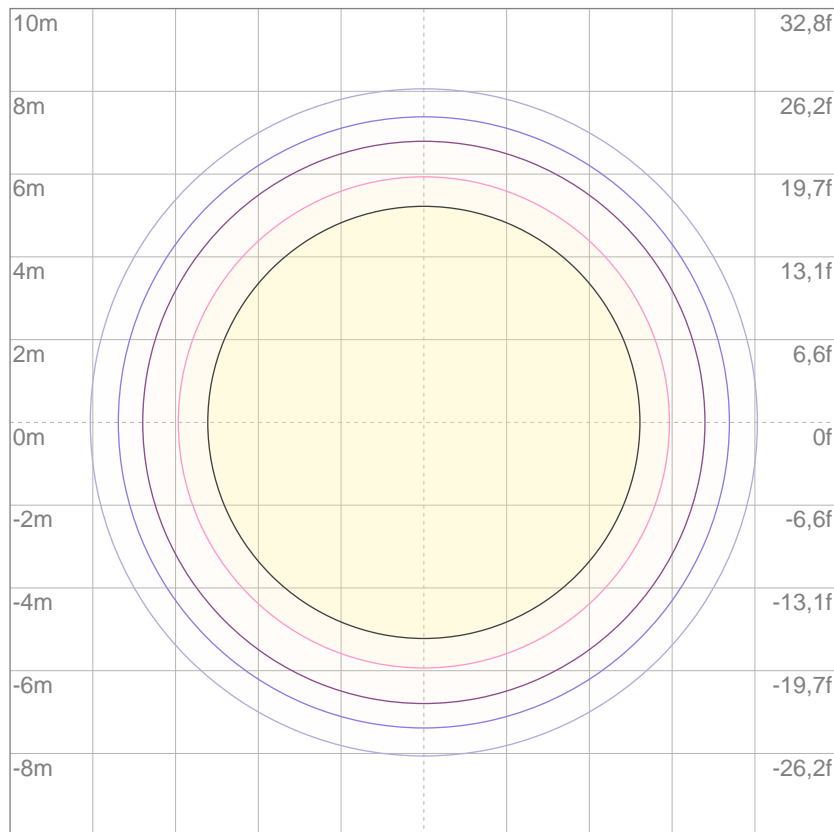

3%	0,799 lx
5%	1,33 lx
10%	2,66 lx
30%	7,99 lx
50%	13,3 lx

Conditions:

Number of c-planes: 2

Lux at center: 26,6 lx

*Lux distribution on a surface when lamp is mounted at 10 meters from the surface.*

Mounting height: 10 meters (33 feet)



Total lumen output:

1322 lm

Peak candela output:

7364 cd

Light quality:

CRI: 93,4

Color temperature:

3964 K

**PRODUCT NAME:**  
ECLDISPLAY

**MEASUREMENT CONDITIONS:**

Beam angle:  
Wash 25-50 Min Zoom

Target:  
4000K

Operator:  
Paolo Carvone

Date and time:  
19/01/2021 17:31:45

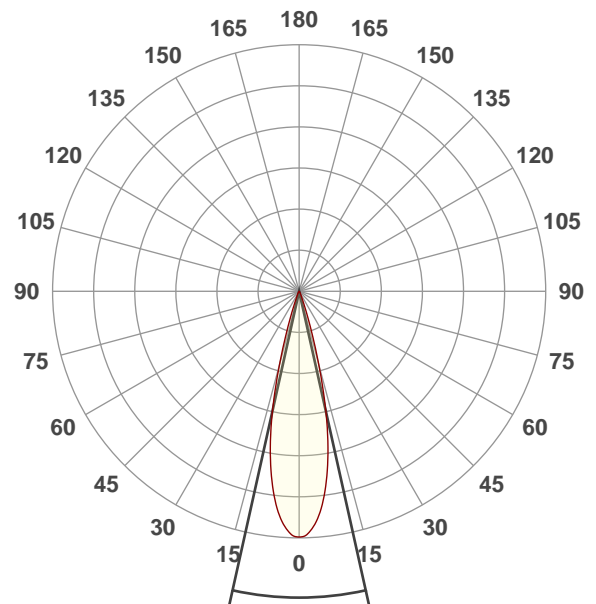

Beam angle 50%: 25,1°  
Field angle 10%: 37,6°  
Cut off angle 2.5%: 46,8°

Spectra

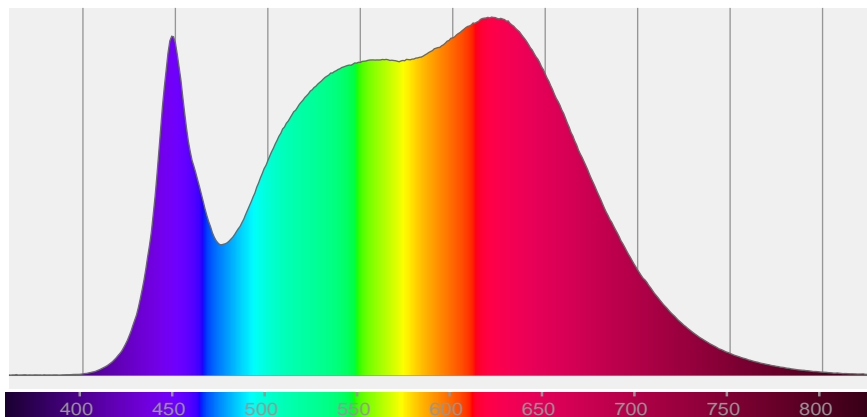

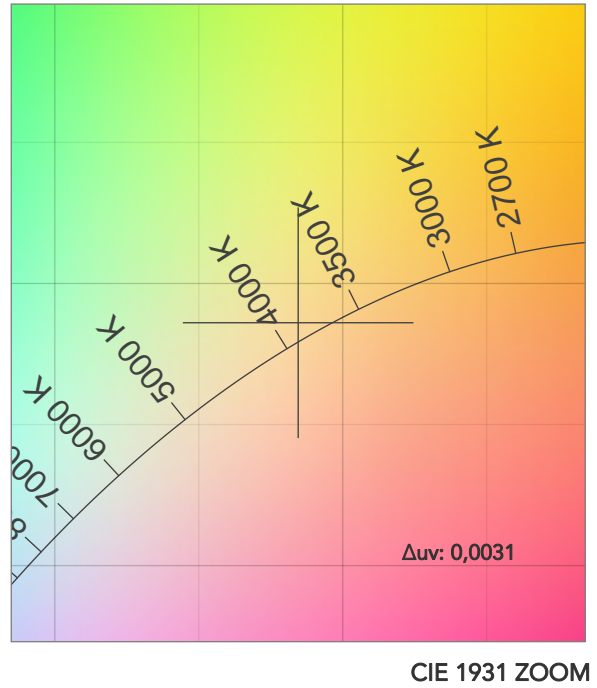
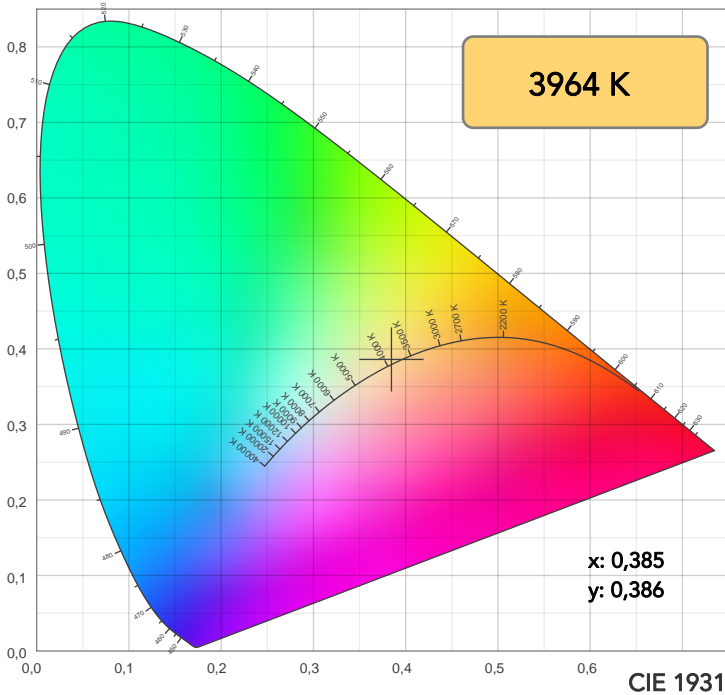

TM30: 91,8

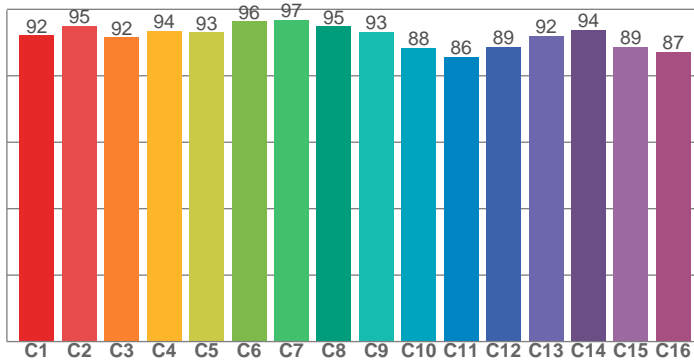

CRI: 93,4 (R1-R8)

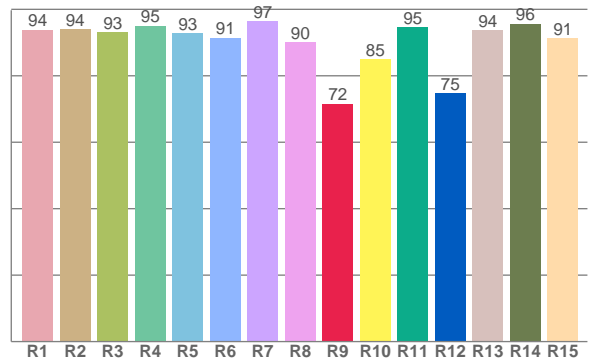

CRI R values, only R1-R8 are used to calculate final CRI value

R1	R2	R3	R4	R5	R6	R7	R8	R9	R10	R11	R12	R13	R14	R15
93,9	94,0	93,0	95,0	92,8	91,5	96,5	90,2	71,6	84,9	94,7	74,7	93,7	95,6	91,4

TM30 C values, 16 binned values out of total of 99 C values

C1	C2	C3	C4	C5	C6	C7	C8	C9	C10	C11	C12	C13	C14	C15	C16
92,1	95,0	91,6	93,6	93,1	96,3	96,8	94,9	93,1	88,4	85,6	88,8	92,1	93,9	88,8	87,2

CQS Q values

Q1	Q2	Q3	Q4	Q5	Q6	Q7	Q8	Q9	Q10	Q11	Q12	Q13	Q14	Q15
93,8	99,1	88,6	89,6	93,2	93,7	94,3	97,0	97,6	95,0	95,3	96,1	96,5	92,0	92,7

CQS: 93,7

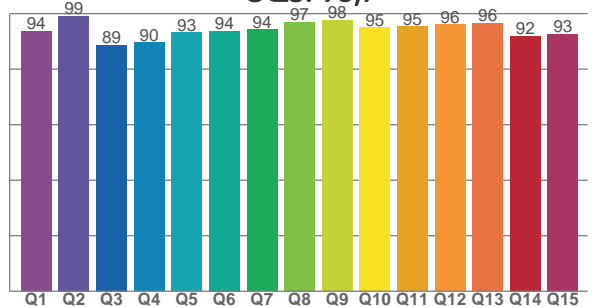

COLOR PARAMETERS

Color temperature	Color rendering index	Red component	Color fidelity	Color gamut	Color quality scale	Television lighting index	Color coordinate cie 1931	Color coordinate cie 1931	Color deviation from black body
CCT	CRI	CRI R9	TM30 Rf	TM30 Rg	CQS	TLCI	x	y	Δuv
3964 K	93,4	71,6	91,8	99,7	93,7	95	0,385	0,386	0,0031

# TM30 DETAILS

**Rf 91,8**  
Fidelity index Rf

**Rg 99,7**  
Gammut index

Hue Bin	R <sub>f</sub>	Graphic shifts (%)	
		Chroma	Hue
1	92	-3%	-1%
2	95	-2%	1%
3	92	-2%	3%
4	94	-1%	2%
5	93	-1%	2%
6	96	1%	0%
7	97	-1%	-1%
8	95	-2%	0%
9	93	-3%	3%
10	88	-3%	6%
11	86	2%	8%
12	89	3%	4%
13	92	4%	-2%
14	94	4%	-2%
15	89	2%	-7%
16	87	0%	-7%

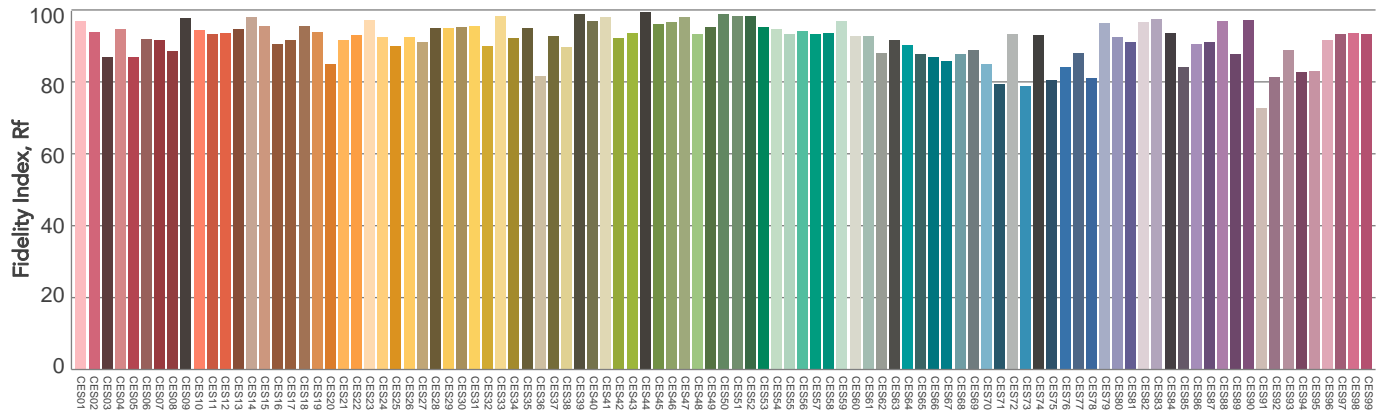
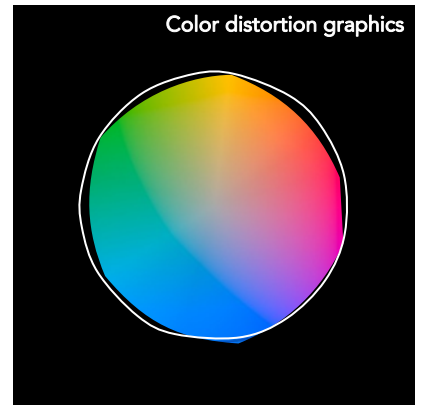
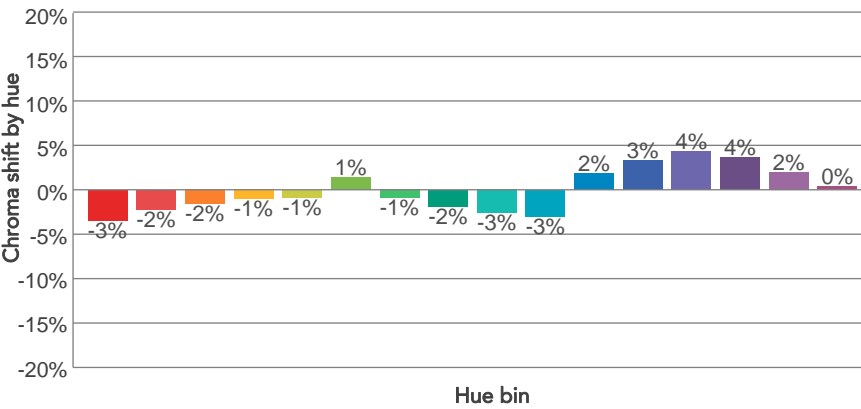
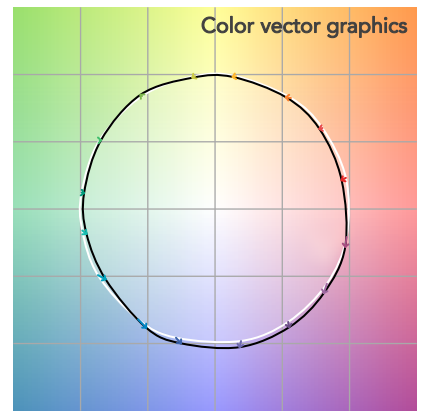
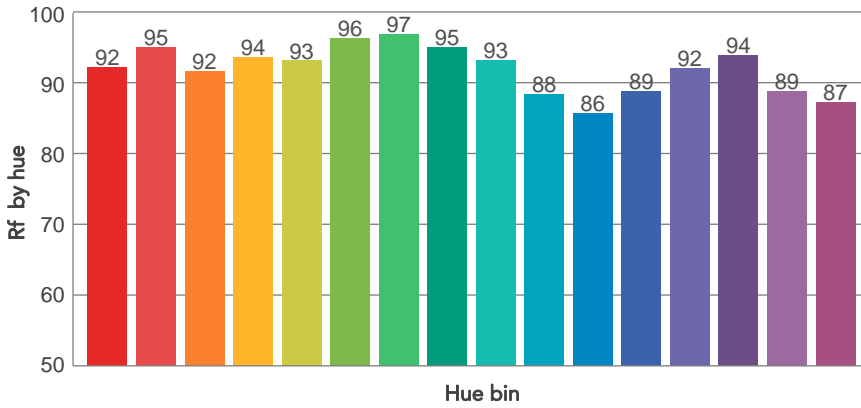
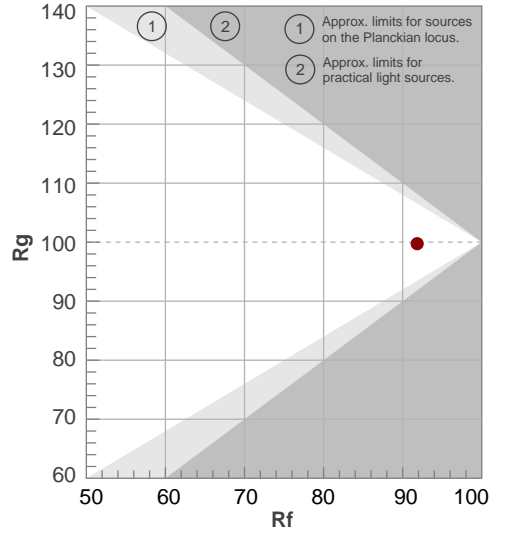

# BEAM DETAILS



Beam angle 50%	Field angle 10%	Cut off angle 2,5%	Intensity ratio in 120° cone	Intensity ratio in 90° cone
25,1°	37,6°	46,8°	99,9%	99,4%

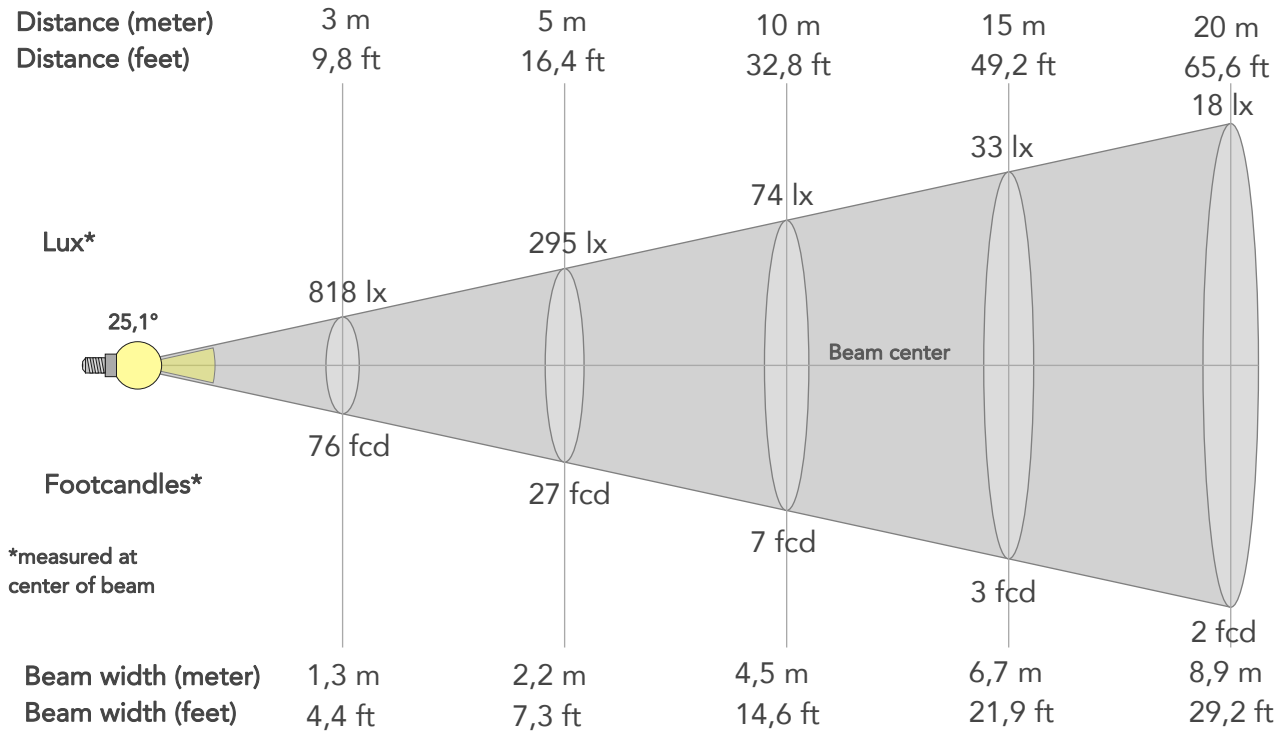

## BEAM INTENSITIES AND WIDTHS

Distance	1m	2m	3m	4m	5m	7,5m	10m	15m	20m	25m	30m	40m	50m
Distance	3,3ft	6,6ft	9,8ft	13,1ft	16,4ft	24,6ft	32,8ft	49,2ft	65,6ft	82ft	98,4ft	131,2ft	164ft
Lux	7364lx	1841lx	818lx	460lx	295lx	131lx	74lx	33lx	18lx	12lx	8lx	5lx	3lx
Footcand.	684fcd	171fcd	76fcd	43fcd	27fcd	12fcd	7fcd	3fcd	2fcd	1fcd	1fcd	0fcd	0fcd
Beam wid.	0,4m	0,9m	1,3m	1,8m	2,2m	3,3m	4,5m	6,7m	8,9m	11,1m	13,4m	17,8m	22,3m
Beam wid.	1,5ft	2,9ft	4,4ft	5,8ft	7,3ft	11ft	14,6ft	21,9ft	29,2ft	36,5ft	43,8ft	58,4ft	73ft

## LINEAR DISTRIBUTION DIAGRAM

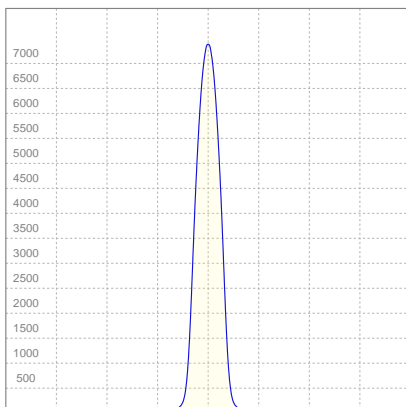

## ELECTRICAL SPECIFICATIONS

Input voltage	Input current	Input power	Effeciency
222V	0,161A	33,7W	39lm/W

Power Fc
0,95



## ISO CANDELA DIAGRAM

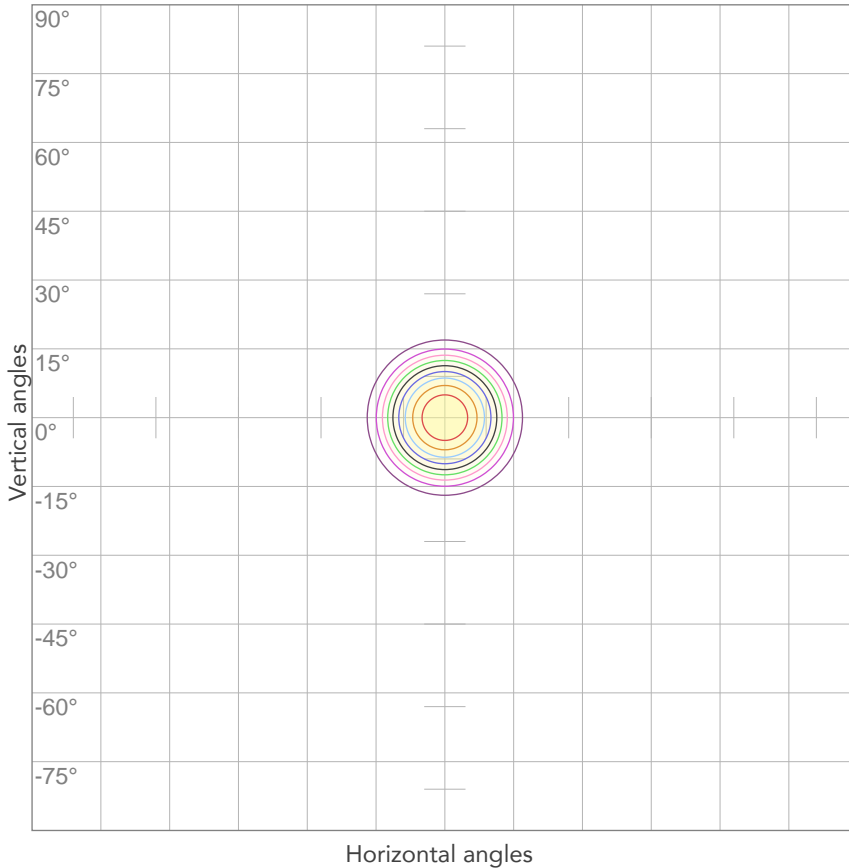

10%	736 cd
20%	1473 cd
30%	2209 cd
40%	2946 cd
50%	3682 cd
60%	4419 cd
70%	5155 cd
80%	5892 cd

Conditions:

Number of c-planes: 2

Candela at center: 7364 cd

## ISO LUX DIAGRAM

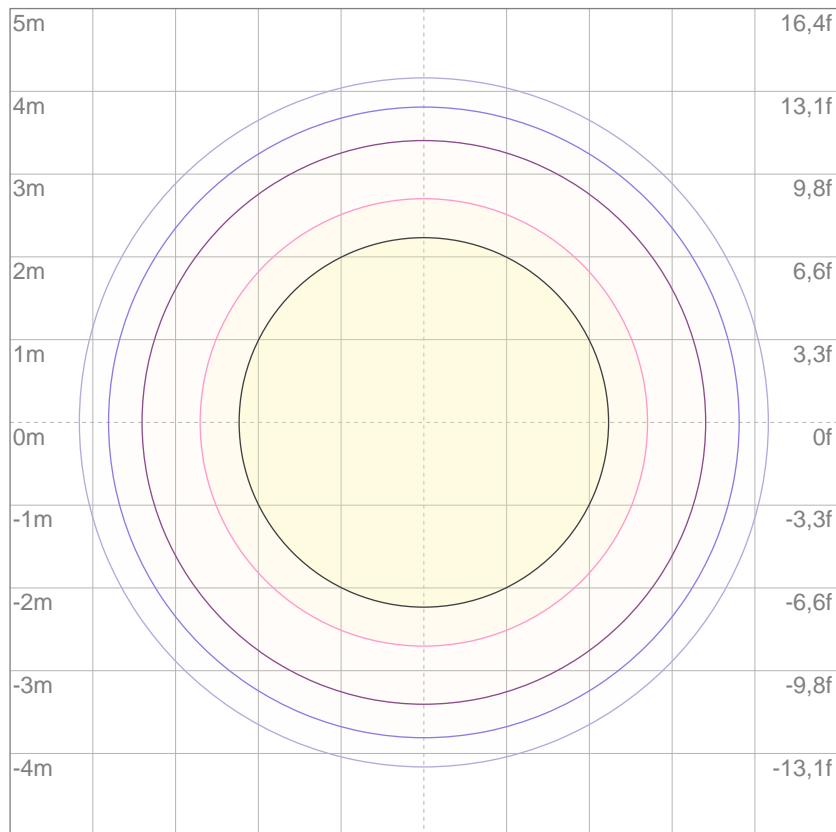

3%	2,21 lx
5%	3,68 lx
10%	7,36 lx
30%	22,1 lx
50%	36,8 lx

Conditions:

Number of c-planes: 2

Lux at center: 73,6 lx

*Lux distribution on a surface when lamp is mounted at 10 meters from the surface.*

Mounting height: 10 meters (33 feet)



Total lumen output:

1884 lm

Peak candela output:

2690 cd

Light quality:

CRI: 91,1

Color temperature:

5707 K

**PRODUCT NAME:**

**ECLDISPLAY**

**MEASURAMENT CONDITIONS:**

Beam angle:

Wash 25-50 Max Zoom

Target:

5600K

Operator:

Paolo Carvone

Date and time:

19/01/2021 18:11:46

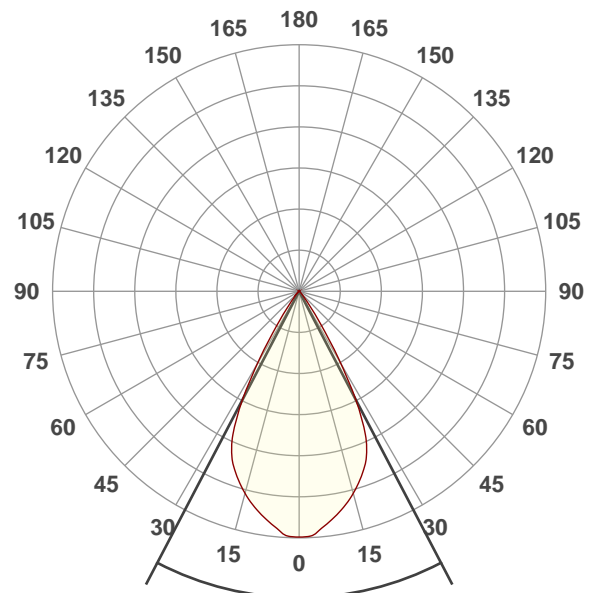

Beam angle 50%: 55,2°

Field angle 10%: 70,5°

Cut off angle 2.5%: 82,1°

Spectra

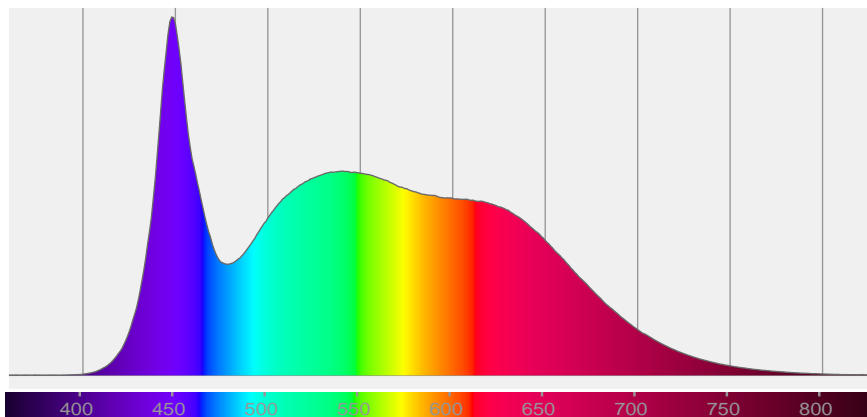

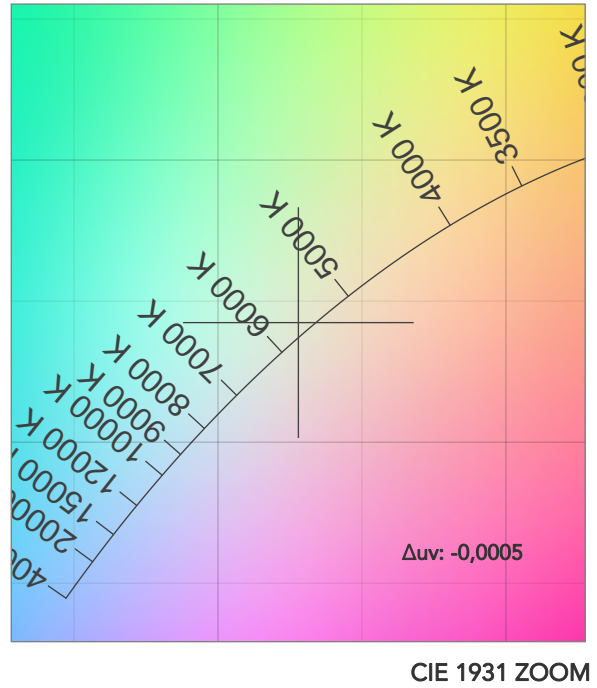
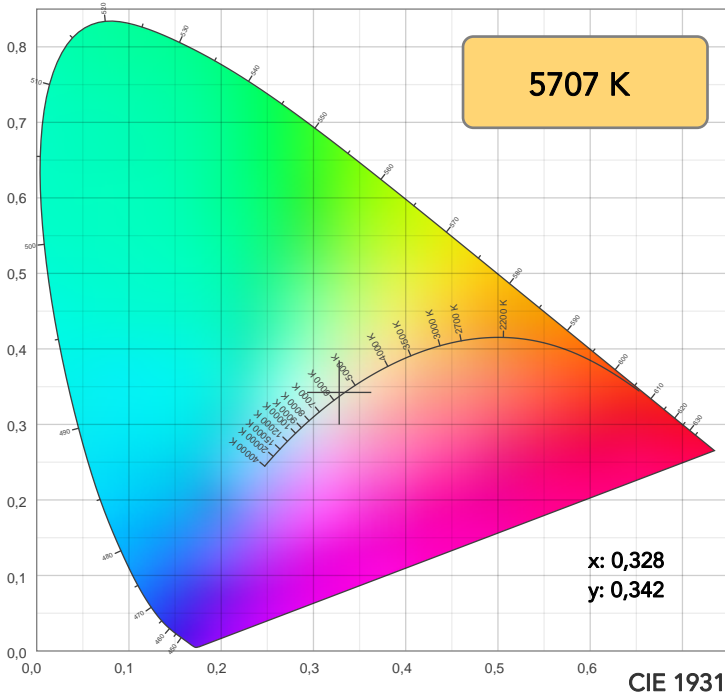

TM30: 89,0

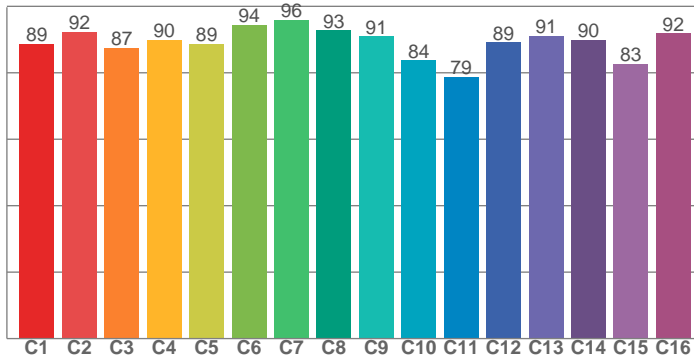

CRI: 91,1 (R1-R8)

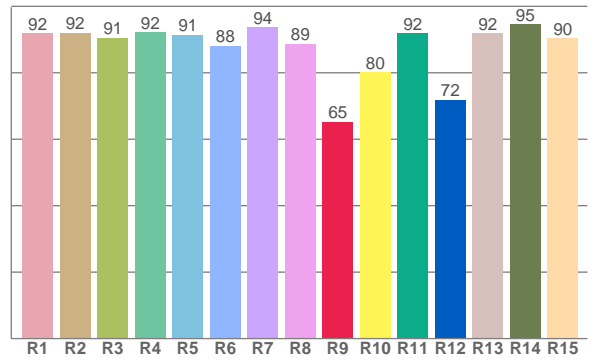

CQS: 90,1

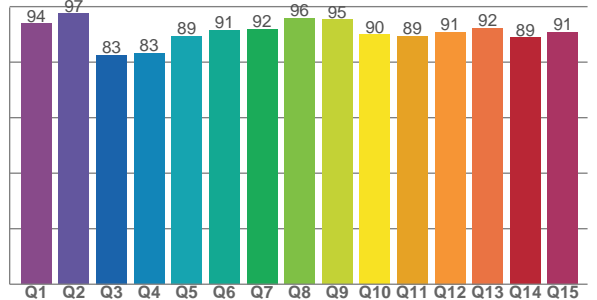

CRI R values, only R1-R8 are used to calculate final CRI value

R1	R2	R3	R4	R5	R6	R7	R8	R9	R10	R11	R12	R13	R14	R15
91,9	92,1	90,5	92,3	91,5	88,2	93,6	88,7	65,3	80,1	92,0	71,9	91,8	94,6	90,5

TM30 C values, 16 binned values out of total of 99 C values

C1	C2	C3	C4	C5	C6	C7	C8	C9	C10	C11	C12	C13	C14	C15	C16
88,7	92,4	87,4	89,9	88,7	94,4	96,0	92,8	91,0	83,7	78,8	89,2	91,1	89,9	82,7	91,9

CQS Q values

Q1	Q2	Q3	Q4	Q5	Q6	Q7	Q8	Q9	Q10	Q11	Q12	Q13	Q14	Q15
93,9	97,5	82,7	83,2	89,4	91,5	92,0	95,8	95,3	89,9	89,4	90,8	92,3	88,9	90,7

COLOR PARAMETERS

Color temperature	Color rendering index	Red component	Color fidelity	Color gamut	Color quality scale	Television lighting index	Color coordinate cie 1931	Color coordinate cie 1931	Color deviation from black body
CCT	CRI	CRI R9	TM30 Rf	TM30 Rg	CQS	TLCI	x	y	Δuv
5707 K	91,1	65,3	89,0	100,3	90,1	94	0,328	0,342	-0,0005

# TM30 DETAILS

**Rf 89,0**  
Fidelity index Rf

**Rg 100,3**  
Gammut index

Hue Bin	R <sub>f</sub>	Graphic shifts (%)	
		Chroma	Hue
1	89	-5%	-1%
2	92	-3%	2%
3	87	-2%	6%
4	90	0%	5%
5	89	1%	4%
6	94	3%	0%
7	96	0%	-2%
8	93	-3%	-1%
9	91	-5%	4%
10	84	-4%	8%
11	79	1%	12%
12	89	3%	6%
13	91	6%	1%
14	90	5%	-2%
15	83	8%	-12%
16	92	-1%	-4%

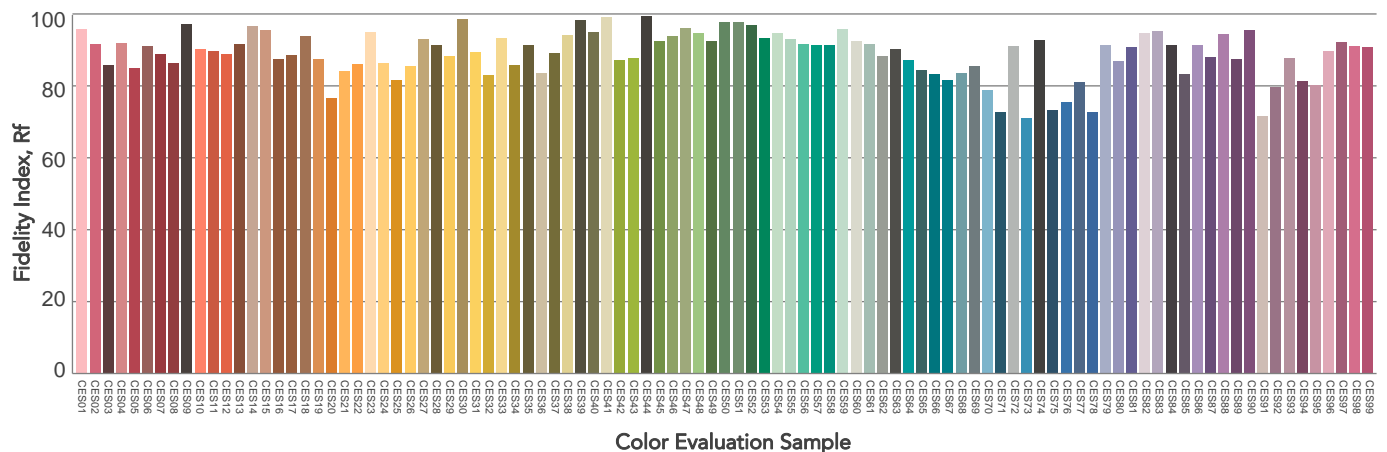
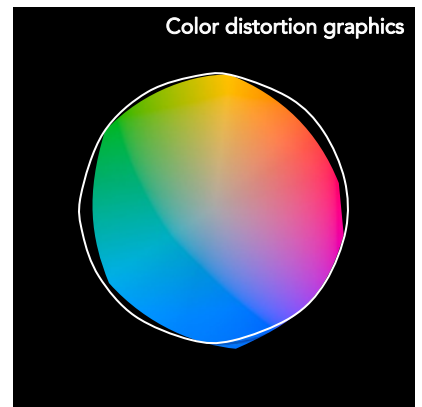
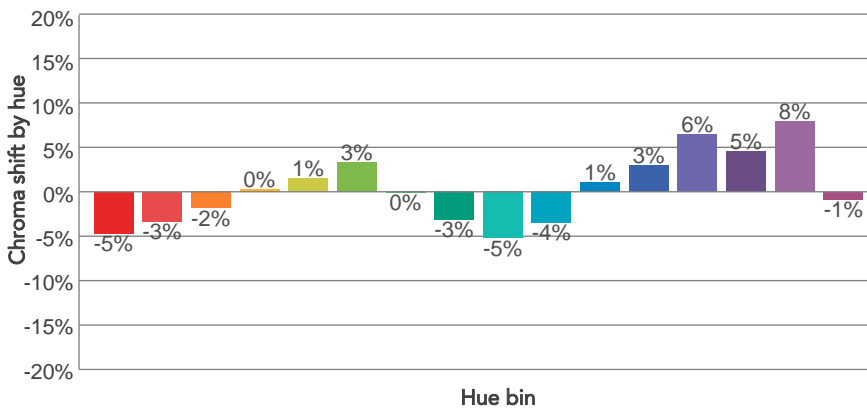
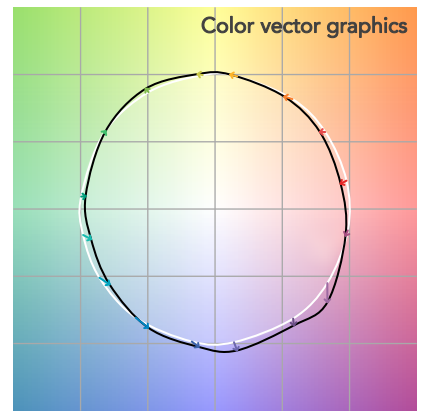
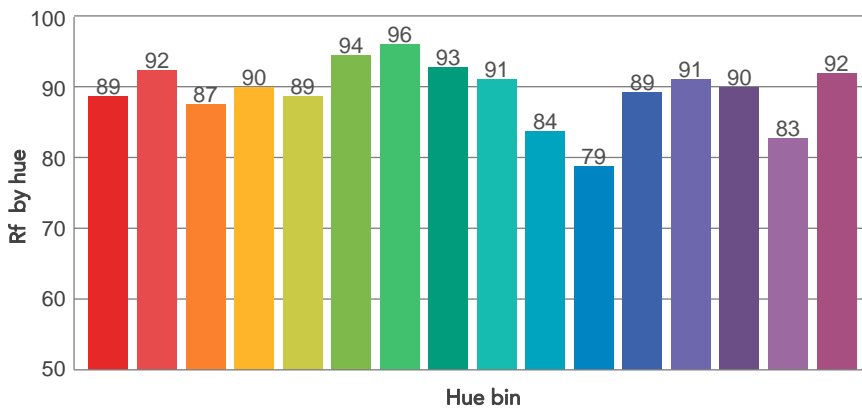
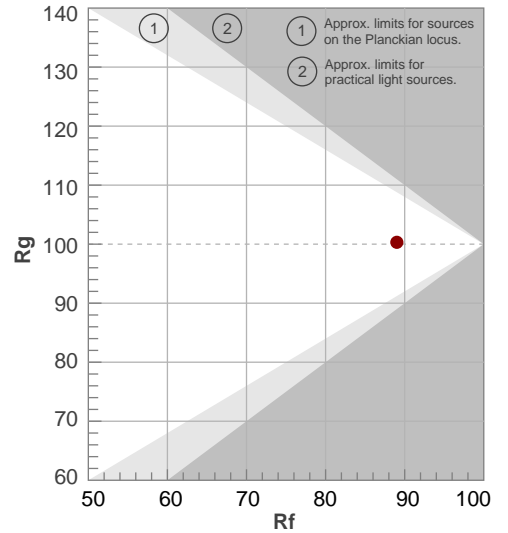

# BEAM DETAILS



Beam angle 50%	Field angle 10%	Cut off angle 2,5%	Intensity ratio in 120° cone	Intensity ratio in 90° cone
55,2°	70,5°	82,1°	99,8%	98,7%

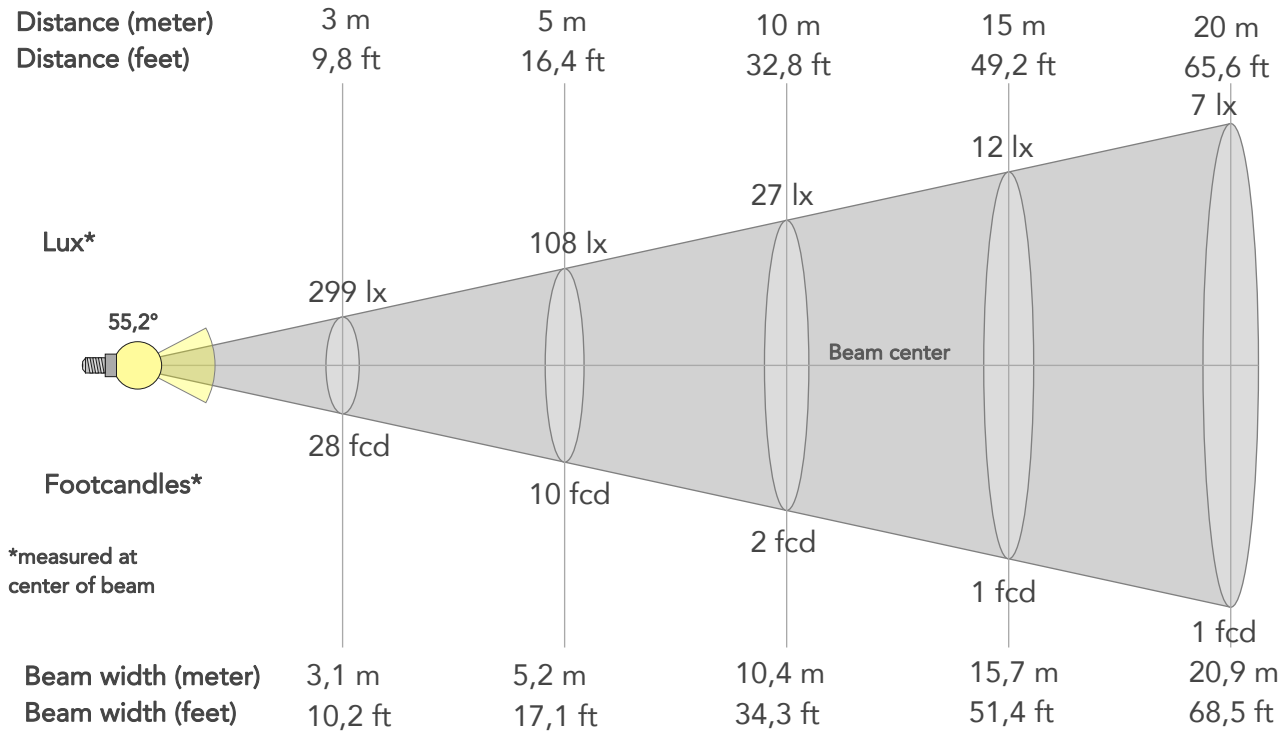

## BEAM INTENSITIES AND WIDTHS

Distance	1m	2m	3m	4m	5m	7,5m	10m	15m	20m	25m	30m	40m	50m
Distance	3,3ft	6,6ft	9,8ft	13,1ft	16,4ft	24,6ft	32,8ft	49,2ft	65,6ft	82ft	98,4ft	131,2ft	164ft
Lux	2690lx	673lx	299lx	168lx	108lx	48lx	27lx	12lx	7lx	4lx	3lx	2lx	1lx
Footcand.	250fcd	62fcd	28fcd	16fcd	10fcd	4fcd	2fcd	1fcd	1fcd	0fcd	0fcd	0fcd	0fcd
Beam wid.	1m	2,1m	3,1m	4,2m	5,2m	7,8m	10,4m	15,7m	20,9m	26,1m	31,3m	41,8m	52,2m
Beam wid.	3,4ft	6,9ft	10,2ft	13,7ft	17,1ft	25,7ft	34,3ft	51,4ft	68,5ft	85,7ft	102,8ft	137,1ft	171,3ft

## LINEAR DISTRIBUTION DIAGRAM

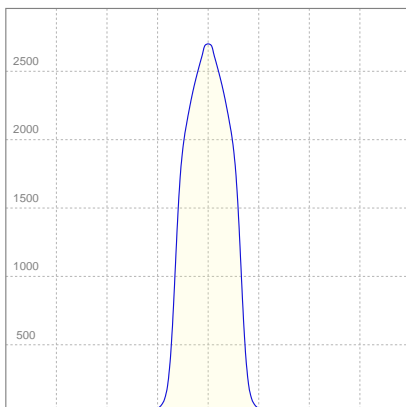

## ELECTRICAL SPECIFICATIONS

Input voltage	Input current	Input power	Effeciency
224V	0,161A	33,8W	56lm/W

Power Fc
0,95

## ISO CANDELA DIAGRAM

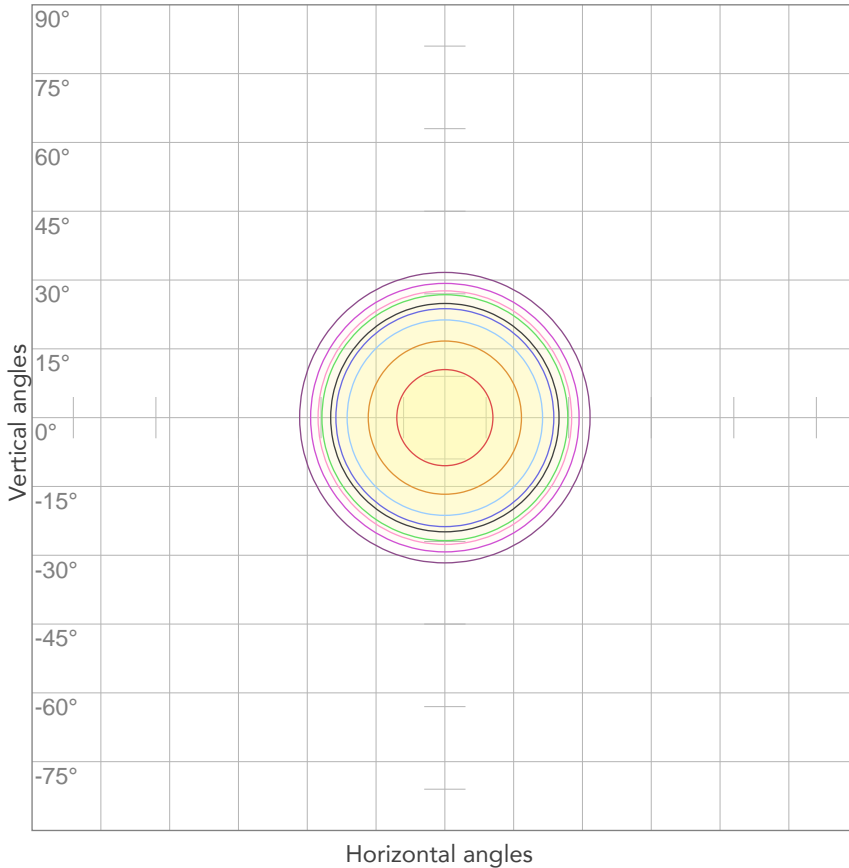

10%	269 cd
20%	538 cd
30%	807 cd
40%	1076 cd
50%	1345 cd
60%	1614 cd
70%	1883 cd
80%	2152 cd

Conditions:

Number of c-planes: 2

Candela at center: 2690 cd

## ISO LUX DIAGRAM

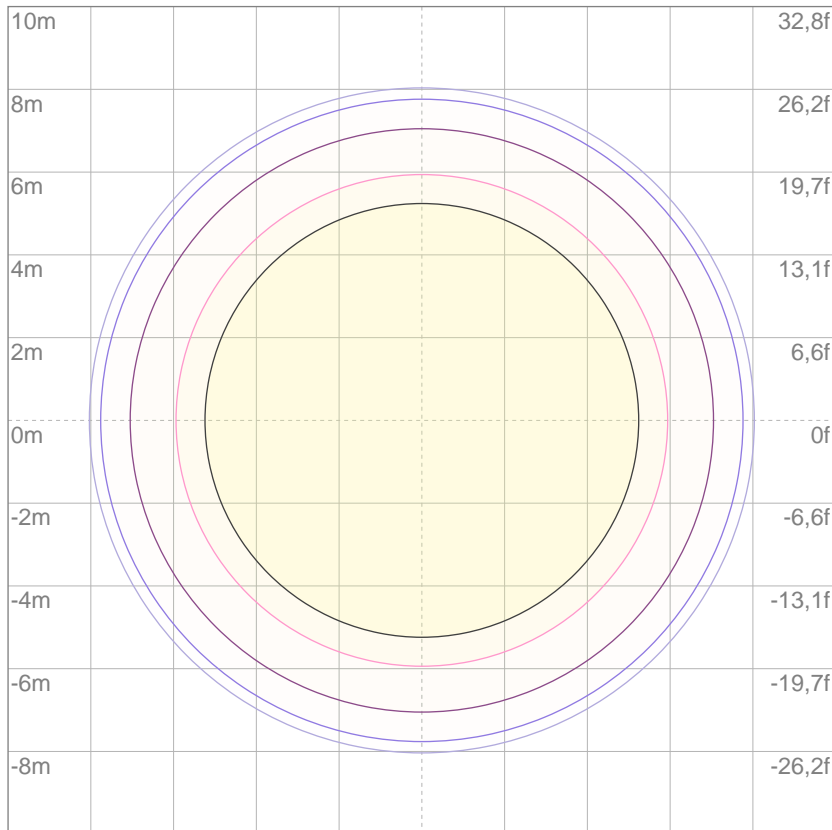

Mounting height: 10 meters (33 feet)

3%	0,807 lx
5%	1,35 lx
10%	2,69 lx
30%	8,07 lx
50%	13,5 lx

Conditions:

Number of c-planes: 2

Lux at center: 26,9 lx

*Lux distribution on a surface when lamp is mounted at 10 meters from the surface.*



Total lumen output:

1341 lm

Peak candela output:

7672 cd

Light quality:

CRI: 91,2

Color temperature:

5644 K

**PRODUCT NAME:**

ECLDISPLAY

**MEASUREMENT CONDITIONS:**

Beam angle:

Wash 25-50 Min Zoom

Target:

5600K

Operator:

Paolo Carvone

Date and time:

19/01/2021 18:09:57

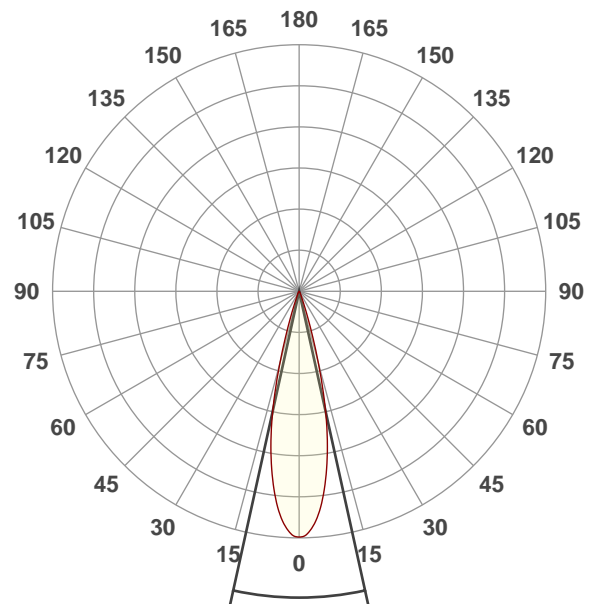

Beam angle 50%: 24,9°

Field angle 10%: 37,2°

Cut off angle 2.5%: 45,8°

Spectra

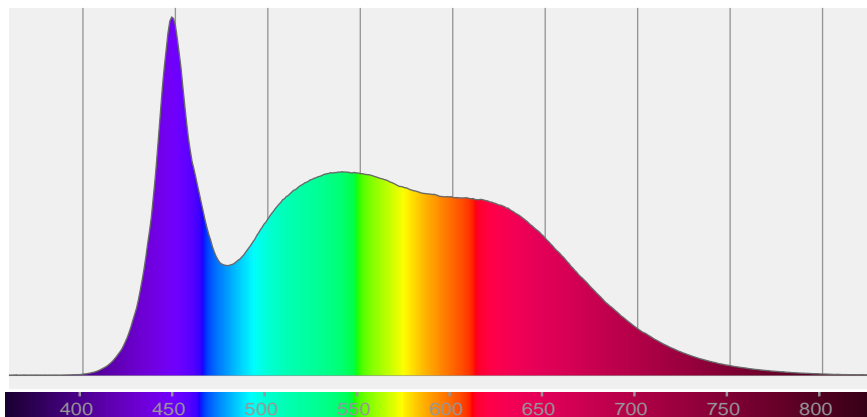

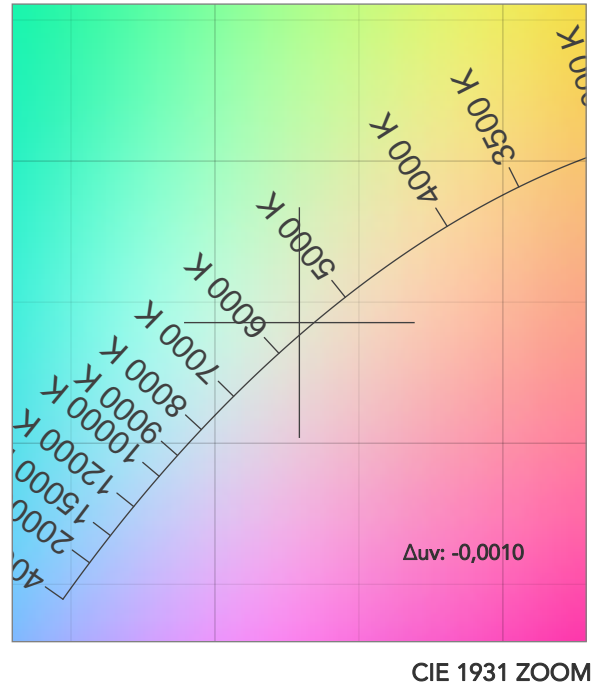
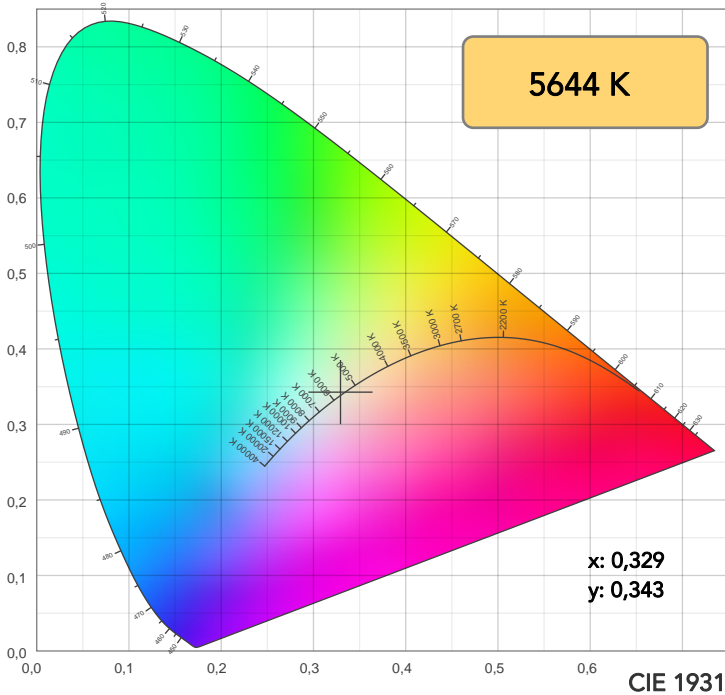

TM30: 89,0

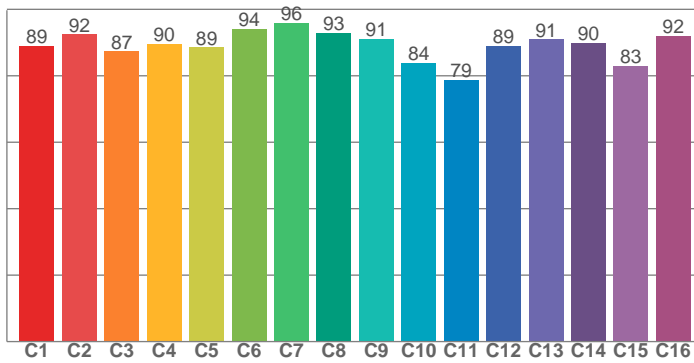

CRI: 91,2 (R1-R8)

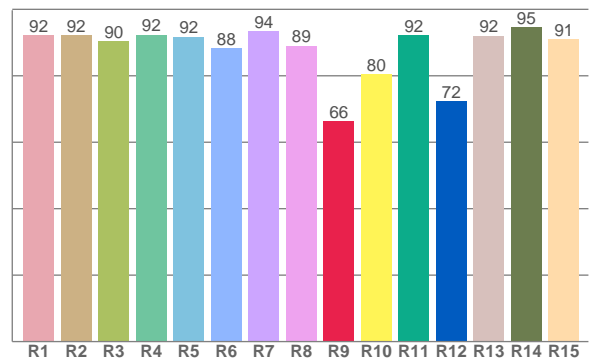

CRI R values, only R1-R8 are used to calculate final CRI value

R1	R2	R3	R4	R5	R6	R7	R8	R9	R10	R11	R12	R13	R14	R15
92,2	92,2	90,4	92,4	91,8	88,3	93,5	89,0	66,3	80,4	92,2	72,3	92,1	94,6	90,9

TM30 C values, 16 binned values out of total of 99 C values

C1	C2	C3	C4	C5	C6	C7	C8	C9	C10	C11	C12	C13	C14	C15	C16
88,9	92,4	87,3	89,7	88,5	94,1	96,0	93,0	91,2	83,9	78,8	88,9	91,0	89,9	83,0	92,0

CQS Q values

Q1	Q2	Q3	Q4	Q5	Q6	Q7	Q8	Q9	Q10	Q11	Q12	Q13	Q14	Q15
94,0	97,3	82,5	83,2	89,6	91,6	91,9	95,9	95,1	89,8	89,3	90,7	92,2	89,1	90,9

CQS: 90,0

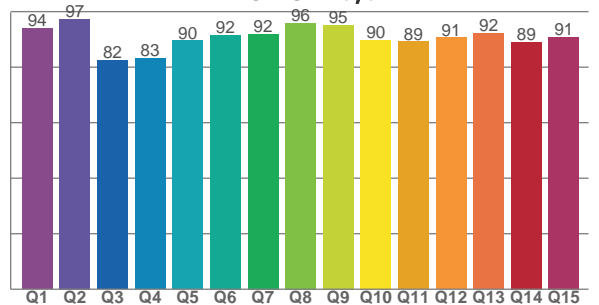

COLOR PARAMETERS

Color temperature	Color rendering index	Red component	Color fidelity	Color gamut	Color quality scale	Television lighting index	Color coordinate cie 1931	Color coordinate cie 1931	Color deviation from black body
CCT	CRI	CRI R9	TM30 Rf	TM30 Rg	CQS	TLCI	x	y	Δuv
5644 K	91,2	66,3	89,0	100,6	90,0	93	0,329	0,343	-0,0010



# TM30 DETAILS

**Rf 89,0**  
Fidelity index Rf

**Rg 100,6**  
Gammut index

Hue Bin	R <sub>f</sub>	Graphic shifts (%)	
		Chroma	Hue
1	89	-5%	-1%
2	92	-3%	2%
3	87	-2%	6%
4	90	0%	5%
5	89	2%	4%
6	94	4%	0%
7	96	0%	-2%
8	93	-3%	-1%
9	91	-5%	4%
10	84	-4%	8%
11	79	1%	12%
12	89	3%	6%
13	91	7%	1%
14	90	5%	-2%
15	83	8%	-11%
16	92	-1%	-4%

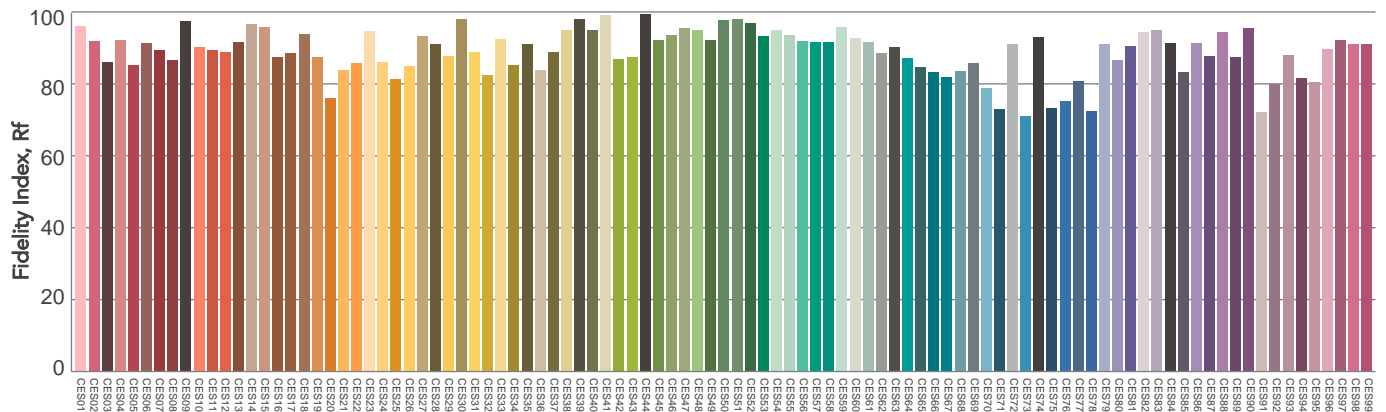
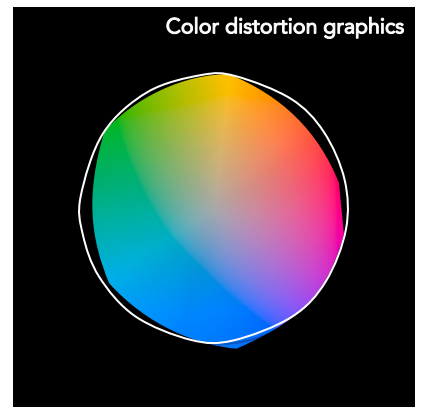
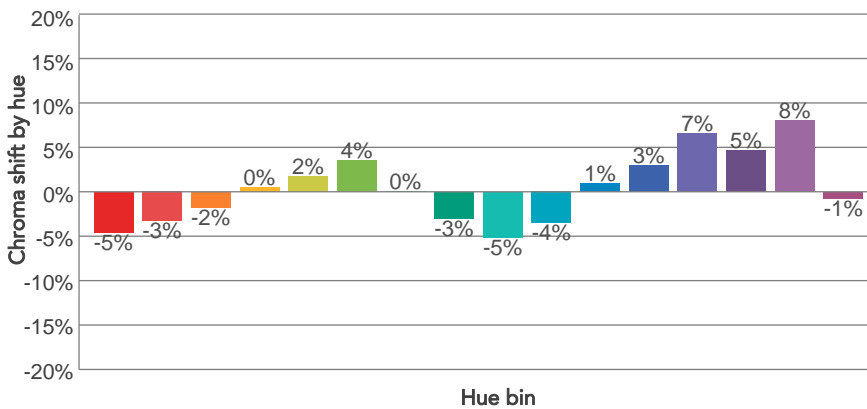
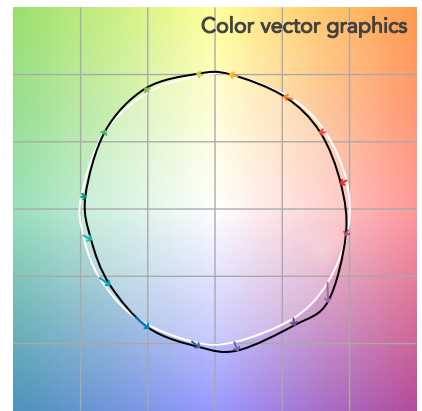
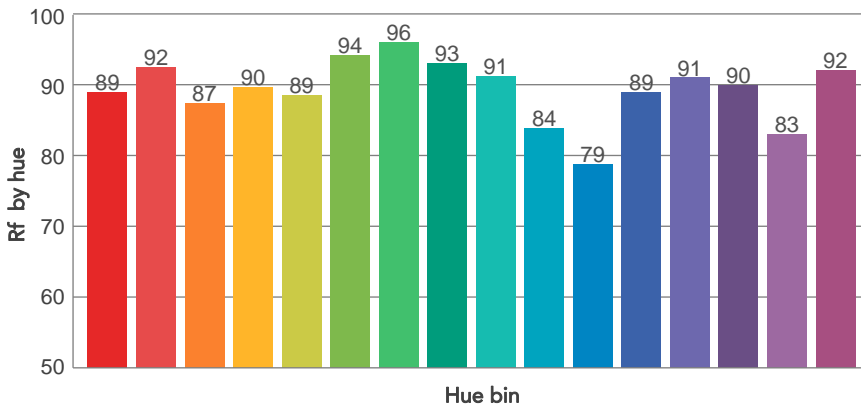
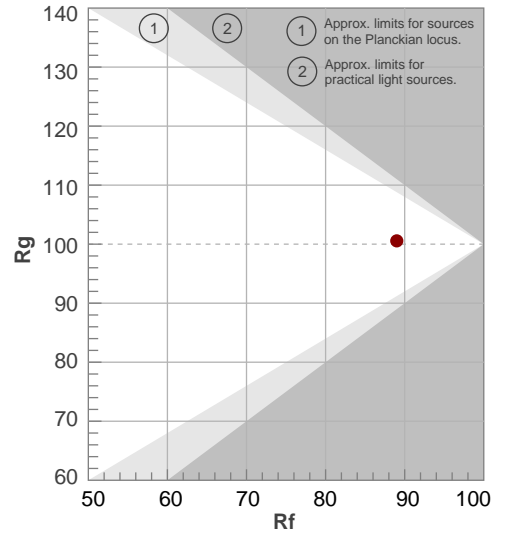

Color Evaluation Sample

# BEAM DETAILS



Beam angle 50%	Field angle 10%	Cut off angle 2,5%	Intensity ratio in 120° cone	Intensity ratio in 90° cone
24,9°	37,2°	45,8°	100,0%	99,5%

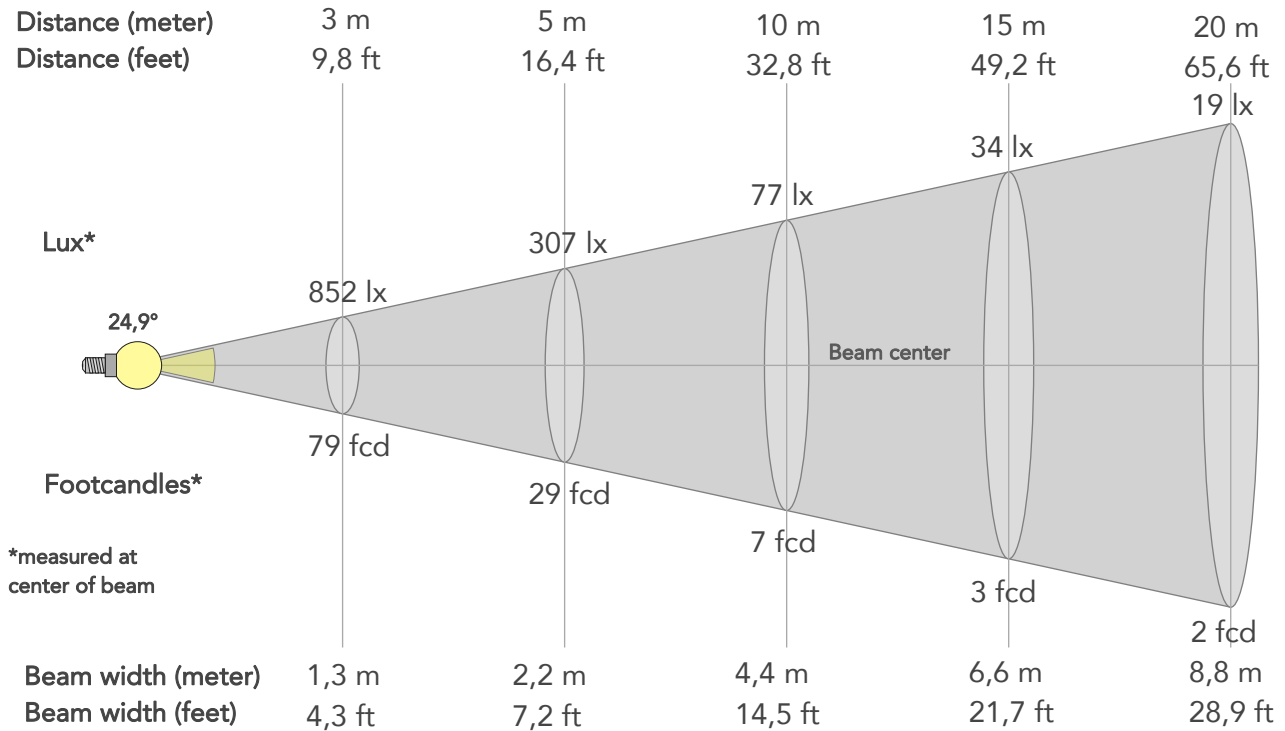

## BEAM INTENSITIES AND WIDTHS

Distance	1m	2m	3m	4m	5m	7,5m	10m	15m	20m	25m	30m	40m	50m
Distance	3,3ft	6,6ft	9,8ft	13,1ft	16,4ft	24,6ft	32,8ft	49,2ft	65,6ft	82ft	98,4ft	131,2ft	164ft
Lux	7672lx	1918lx	852lx	479lx	307lx	136lx	77lx	34lx	19lx	12lx	9lx	5lx	3lx
Footcand.	713fcd	178fcd	79fcd	45fcd	29fcd	13fcd	7fcd	3fcd	2fcd	1fcd	1fcd	0fcd	0fcd
Beam wid.	0,4m	0,9m	1,3m	1,8m	2,2m	3,3m	4,4m	6,6m	8,8m	11m	13,2m	17,6m	22m
Beam wid.	1,5ft	2,9ft	4,3ft	5,8ft	7,2ft	10,8ft	14,5ft	21,7ft	28,9ft	36,1ft	43,4ft	57,8ft	72,3ft

## LINEAR DISTRIBUTION DIAGRAM

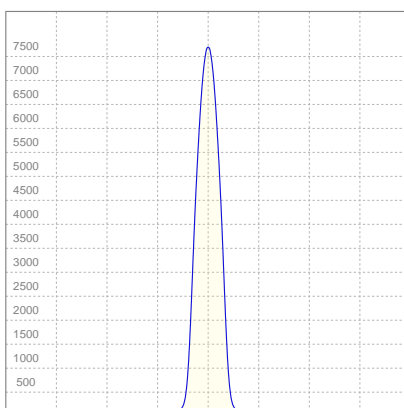

## ELECTRICAL SPECIFICATIONS

Input voltage	Input current	Input power	Effeciency
224V	0,161A	33,9W	40lm/W

Power Fc
0,95

## ISO CANDELA DIAGRAM

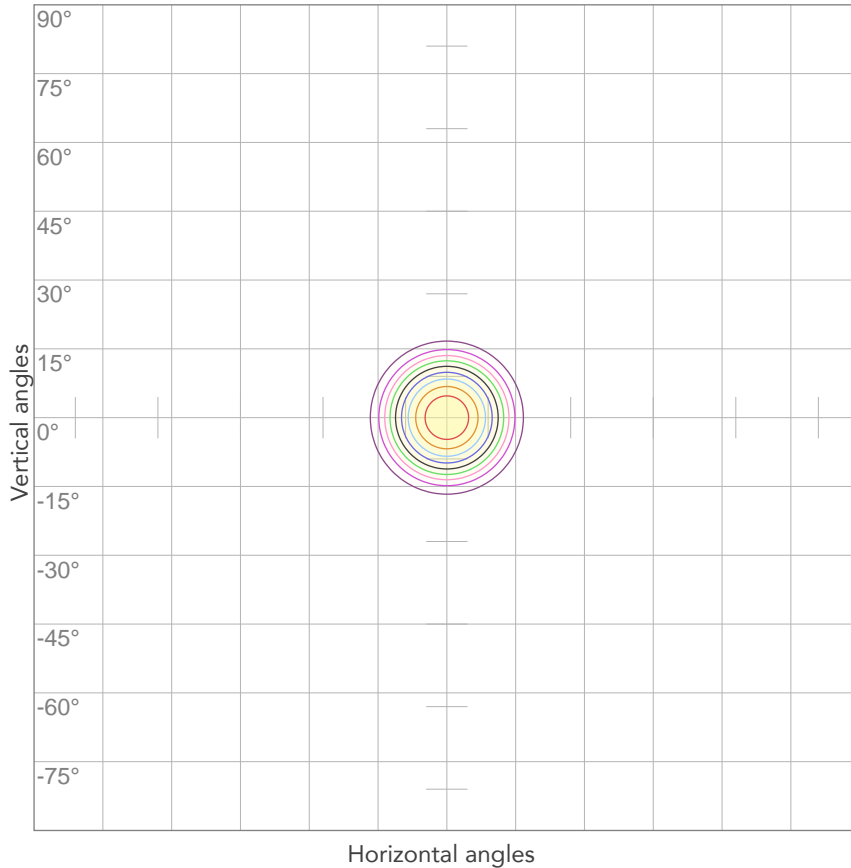

10%	767 cd
20%	1534 cd
30%	2301 cd
40%	3069 cd
50%	3836 cd
60%	4603 cd
70%	5370 cd
80%	6137 cd

Conditions:

Number of c-planes: 2

Candela at center: 7672 cd

## ISO LUX DIAGRAM

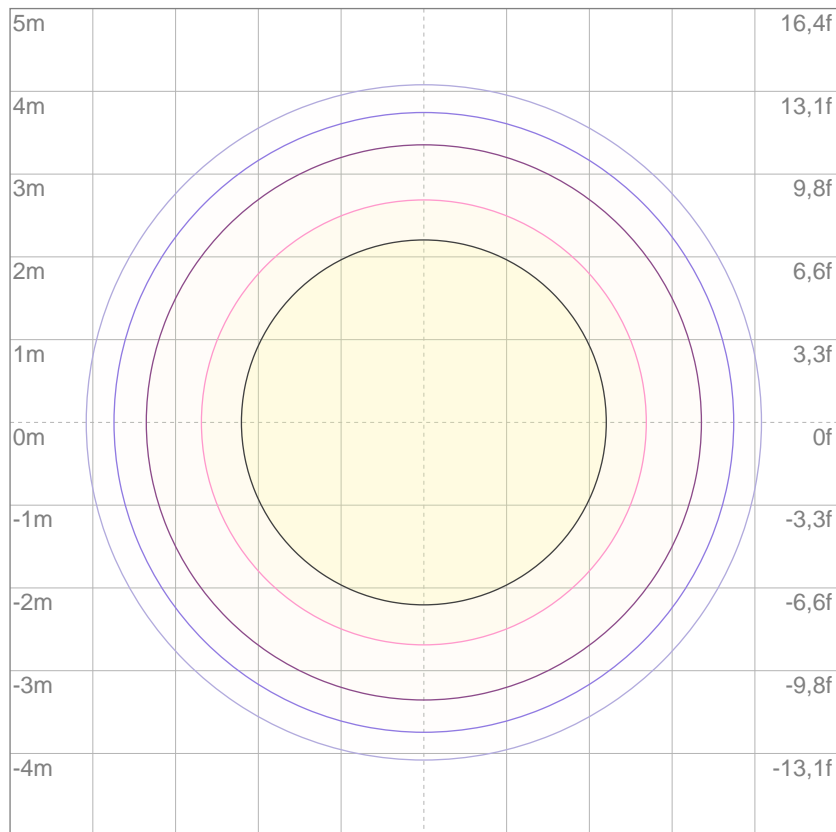

3%	2,30 lx
5%	3,84 lx
10%	7,67 lx
30%	23,0 lx
50%	38,4 lx

Conditions:

Number of c-planes: 2

Lux at center: 76,7 lx

*Lux distribution on a surface when lamp is mounted at 10 meters from the surface.*