

Photometric Test Report



ASTRAHYBRID420IP

IP65 Hybrid moving beam-spot, with
420W USHIO NSL421 lamp

CONTENTS

Table of contents	2
Testing process	3
Preset Full on	
Beam angle Max Zoom	4
Beam angle Med Zoom	9
Beam angle Min Zoom	14

TESTING PROCESS

Prolights has its own optical testing laboratory in order to provide accurate photometric reports for its lighting products. The testing laboratory contains certain variety of precise lighting measurement systems that ensure an optimal reading of all the characteristic parameters of the lighting devices. All measurements are made at a controlled room temperature of 20°C without any external light sources. This photometric report is obtained through the data measured by a high precision measurement system and analyzed by a dedicate software.

Prolights measurement instrument

Prolights measurement instrument is a complete measurement system for any light source. It's equipped with two-axis goniometer, that enables to measure the full 3D distribution field of the light source. This instrument measures the light intensity, the beam angle and the most significative colors parameters, like color temperature, spectral distribution, CRI, CQS, TM-30 with a very high accuracy rate.

Please Note: All measurements are made with light source at operating temperature. Before starting the measurement, the instrument analyzes the process of the light source during the heating phase. The measuring process of all the parameters begins only when the light emission is stable, that is with a variation of less than 0.5% in a 15 minutes time frame.

Prolights measurement software

The software provides user friendly interface for the operator who does the measurements, and it also analyzes and processes all the collected data by the instrument. With this software it is possible to see the measured data in real-time and it is possible to examine all the measured data and graphics afterwards as well. All information is collected in a specific Prolights template, and the software creates also IES and LDT files, which are widely used to transfer the photometric data, and to develop lighting system.

Additionally, the fixtures are rechecked using various hand-held instruments like Sekonic C-700 and Gossen Mavospec Base, this is done to ensure, that the data in the photometric report are as accurate as possible.



Peak candela output:

193901 cd

Light quality:

CRI: 81,4

Color temperature:

6546 K

PRODUCT NAME:

ASTRAHYB420IP

MEASURAMENT CONDITIONS:

Beam angle:

Max Zoom

Target:

Full On

Operator:

Paolo Carvone

Date and time:

03/02/2021 17:40:57

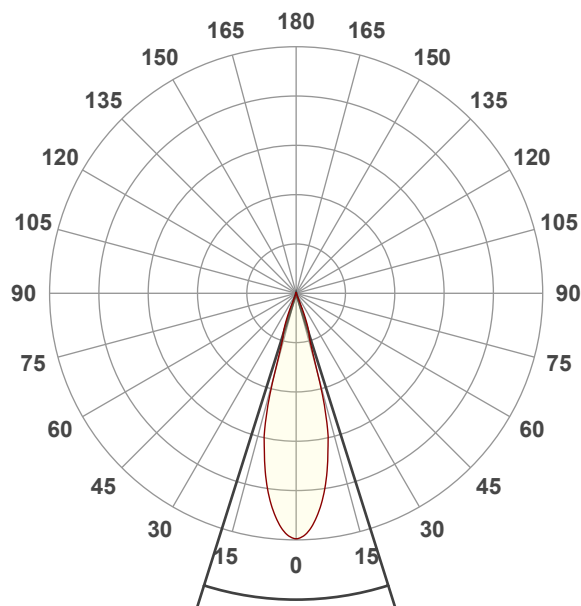

Beam angle 50%: 35°
 Field angle 10%: 41,2°
 Cut off angle 2.5%: 214,3°

Spectra

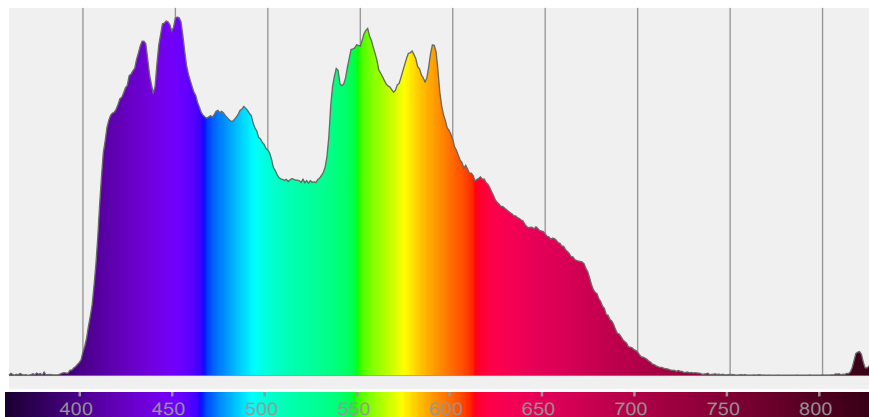

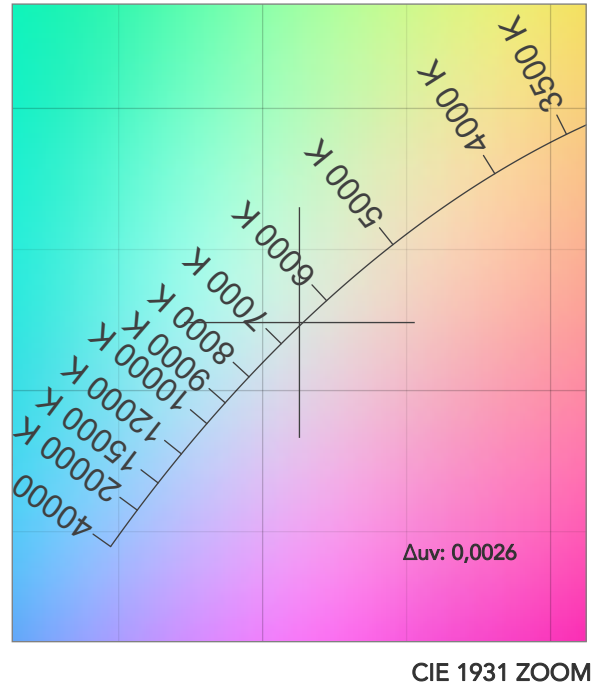
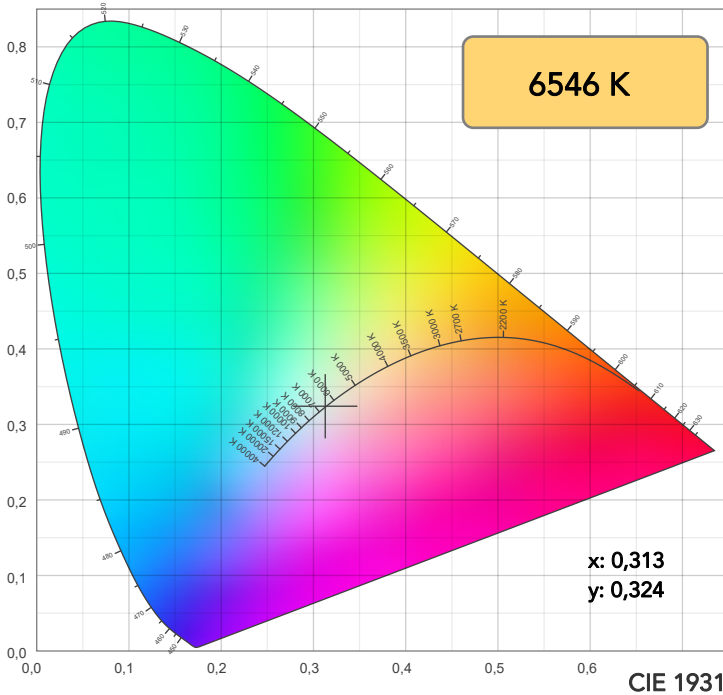

TM30: 83,6

CRI: 81,4 (R1-R8)

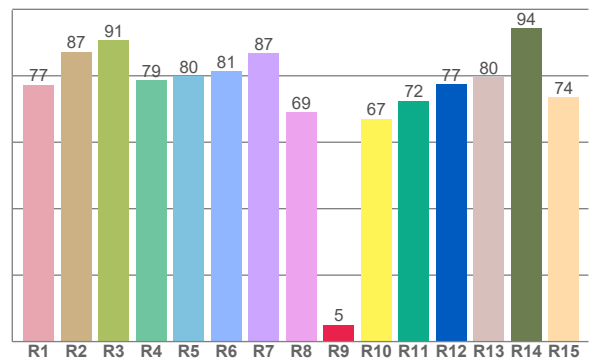
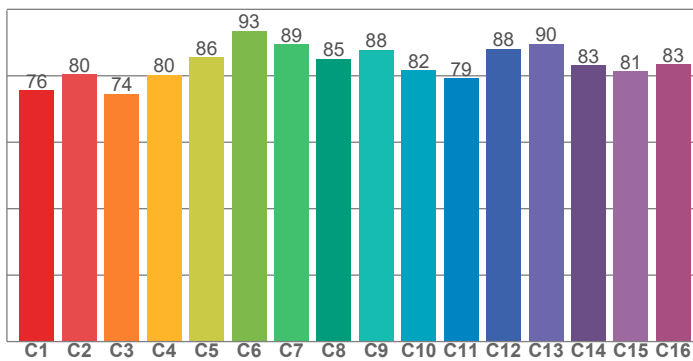

CRI R values, only R1-R8 are used to calculate final CRI value

R1	R2	R3	R4	R5	R6	R7	R8	R9	R10	R11	R12	R13	R14	R15
77,3	87,3	90,8	78,6	79,9	81,3	86,7	69,0	5,1	67,1	72,4	77,5	79,6	94,4	73,5

TM30 C values, 16 binned values out of total of 99 C values

C1	C2	C3	C4	C5	C6	C7	C8	C9	C10	C11	C12	C13	C14	C15	C16
75,6	80,5	74,5	80,3	85,6	93,5	89,4	85,1	87,8	81,7	79,2	88,1	89,6	83,1	81,3	83,4

CQS Q values

Q1	Q2	Q3	Q4	Q5	Q6	Q7	Q8	Q9	Q10	Q11	Q12	Q13	Q14	Q15
85,5	97,5	81,1	72,4	75,6	77,0	79,0	88,1	95,4	83,2	74,2	73,6	74,2	67,8	74,8

CQS: 78,3

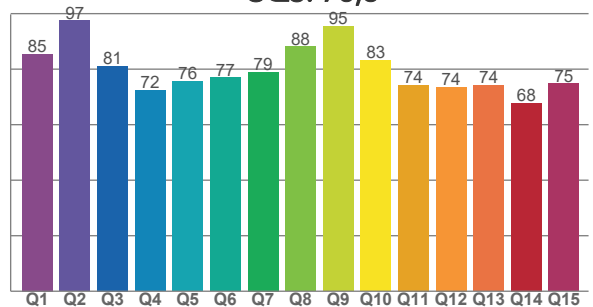

COLOR PARAMETERS

Color temperature	Color rendering index	Red component	Color fidelity	Color gamut	Color quality scale	Television lighting index	Color coordinate cie 1931	Color coordinate cie 1931	Color deviation from black body
CCT	CRI	CRI R9	TM30 Rf	TM30 Rg	CQS	TLCI	x	y	Δuv
6546 K	81,4	5,1	83,6	93,6	78,3	64	0,313	0,324	0,0026

TM30 DETAILS

Rf 83,6
Fidelity index Rf

Rg 93,6
Gammut index

Hue Bin	R _f	Graphic shifts (%)	
		Chroma	Hue
1	76	-14%	-1%
2	80	-10%	8%
3	74	-5%	14%
4	80	3%	12%
5	86	7%	7%
6	93	2%	-3%
7	89	-5%	-4%
8	85	-8%	-3%
9	88	-10%	4%
10	82	-6%	11%
11	79	-1%	11%
12	88	4%	7%
13	90	7%	-2%
14	83	3%	-10%
15	81	-3%	-17%
16	83	-7%	-7%

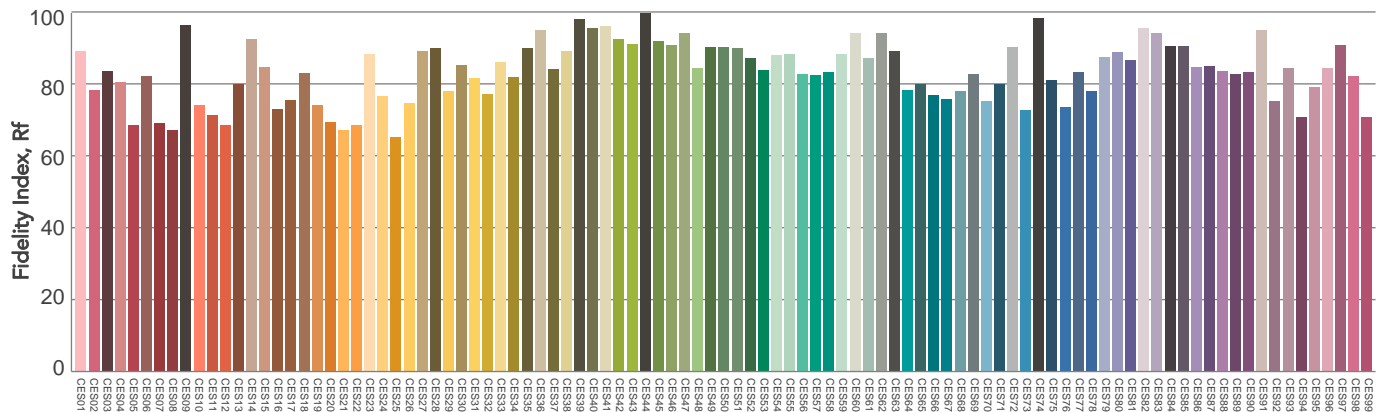
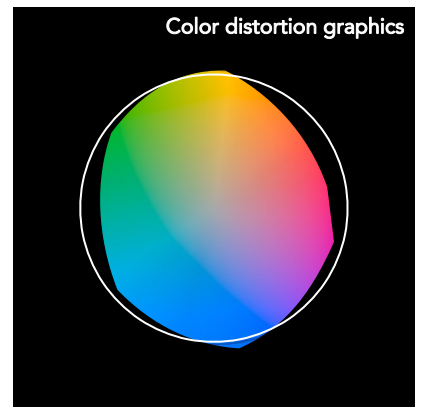
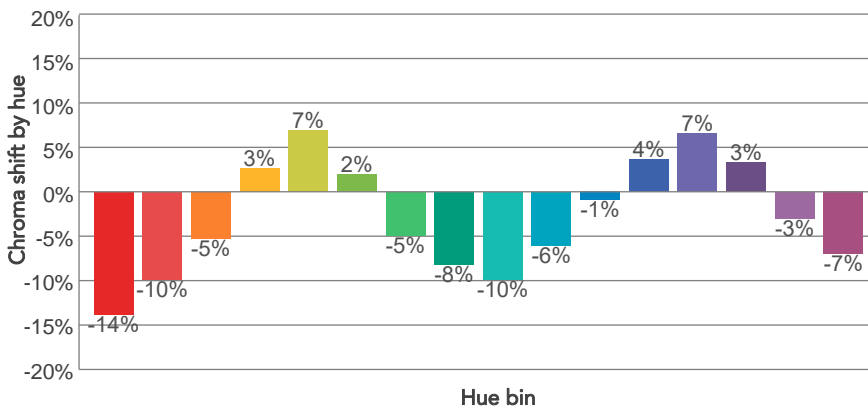
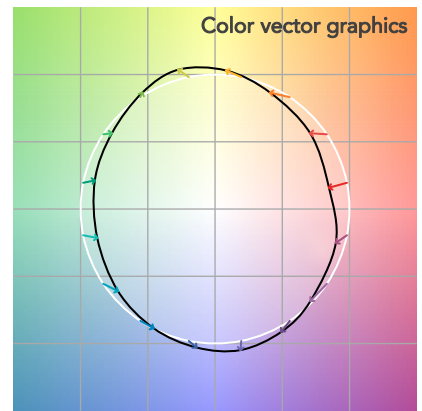
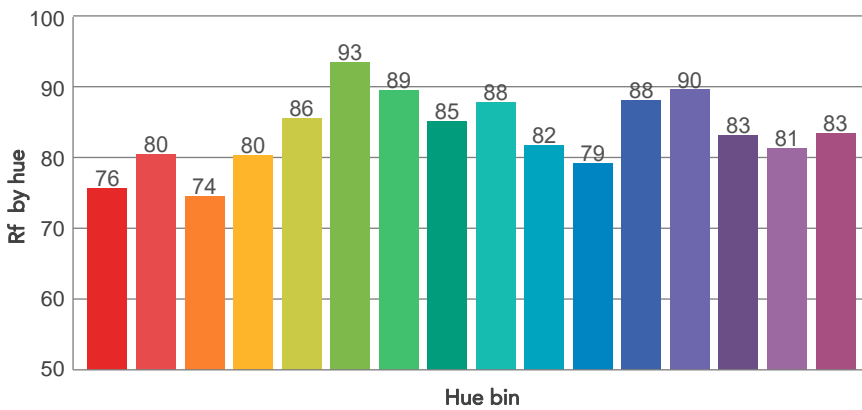
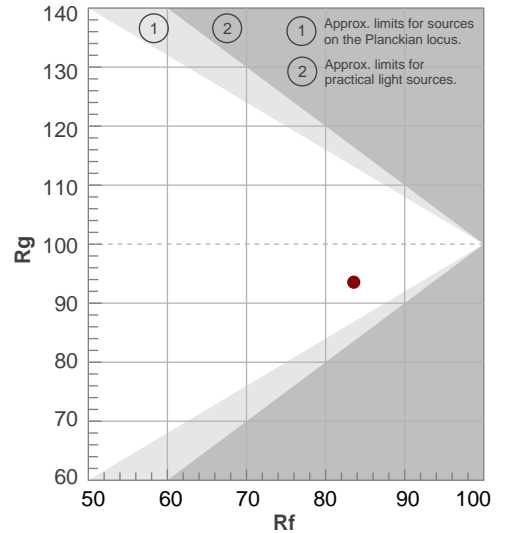

BEAM DETAILS



Beam angle 50%	Field angle 10%	Cut off angle 2,5%	Intensity ratio in 120° cone	Intensity ratio in 90° cone
35°	41,2°	214,3°	58,9%	46,3%

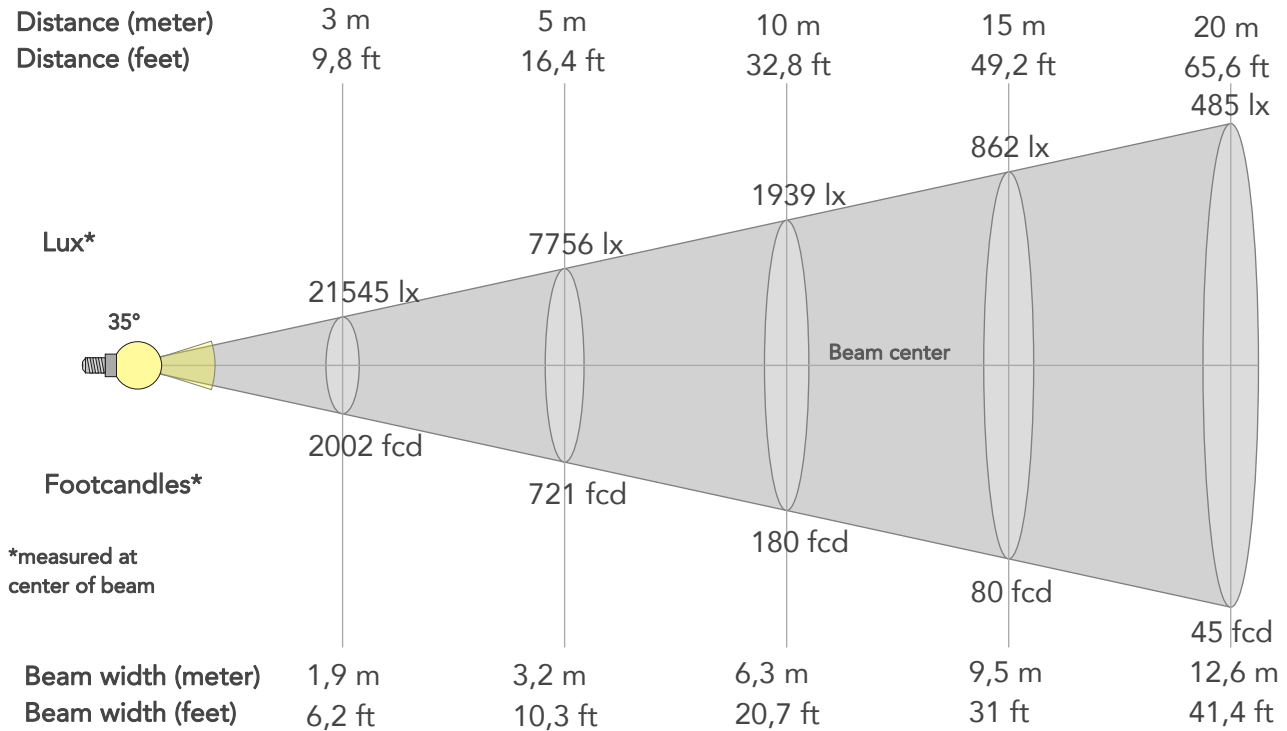

BEAM INTENSITIES AND WIDTHS

Distance	1m	2m	3m	4m	5m	7,5m	10m	15m	20m	25m	30m	40m	50m
Distance	3,3ft	6,6ft	9,8ft	13,1ft	16,4ft	24,6ft	32,8ft	49,2ft	65,6ft	82ft	98,4ft	131,2ft	164ft
Lux	193901lx	48475lx	21545lx	12119lx	7756lx	3447lx	1939lx	862lx	485lx	310lx	215lx	121lx	78lx
Footcand.	18014fcd	4504fcd	2002fcd	1126fcd	721fcd	320fcd	180fcd	80fcd	45fcd	29fcd	20fcd	11fcd	7fcd
Beam wid.	0,6m	1,3m	1,9m	2,5m	3,2m	4,7m	6,3m	9,5m	12,6m	15,8m	18,9m	25,2m	31,5m
Beam wid.	2,1ft	4,2ft	6,2ft	8,3ft	10,3ft	15,5ft	20,7ft	31ft	41,4ft	51,7ft	62,1ft	82,7ft	103,4ft

LINEAR DISTRIBUTION DIAGRAM

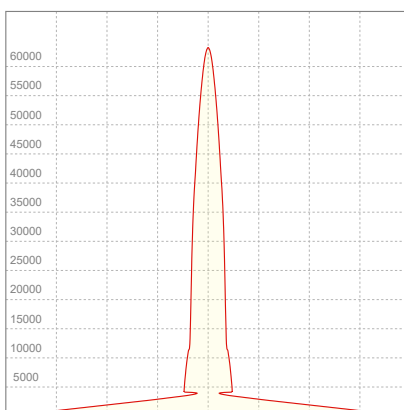

ELECTRICAL SPECIFICATIONS

Input voltage	Input current	Input power	Effeciency
222V	2,28A	486,8W	226lm/W
Power Fc			
0,96			

ISO CANDELA DIAGRAM

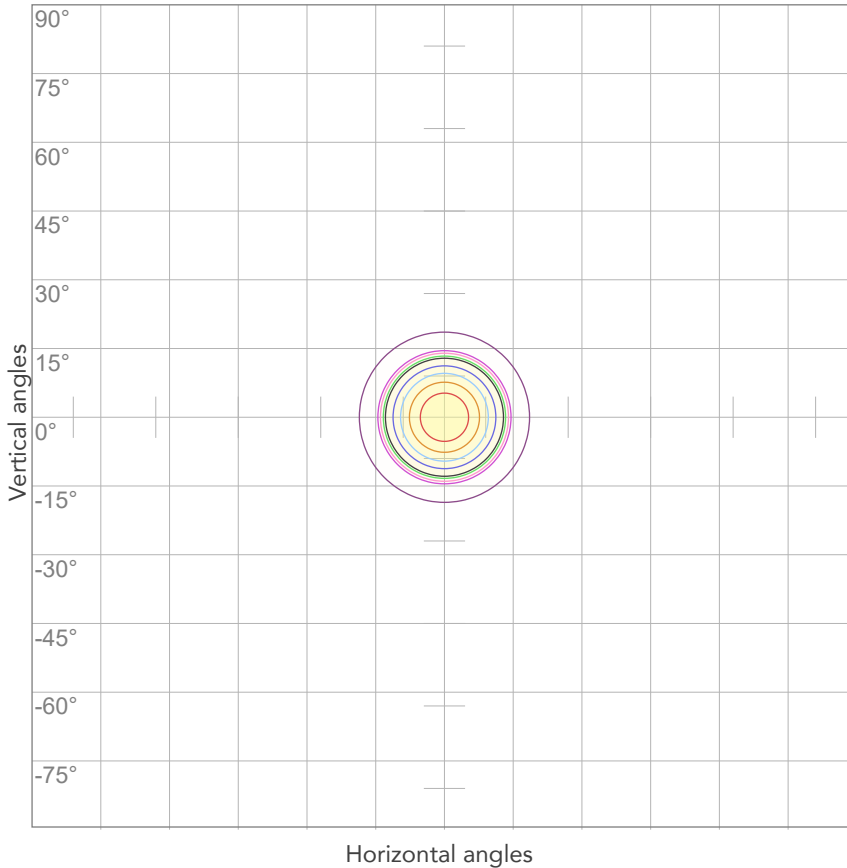

10%	19390 cd
20%	38780 cd
30%	58170 cd
40%	77561 cd
50%	96951 cd
60%	116341 cd
70%	135731 cd
80%	155121 cd

Conditions:

Number of c-planes: 2

Candela at center: 193901 cd

ISO LUX DIAGRAM

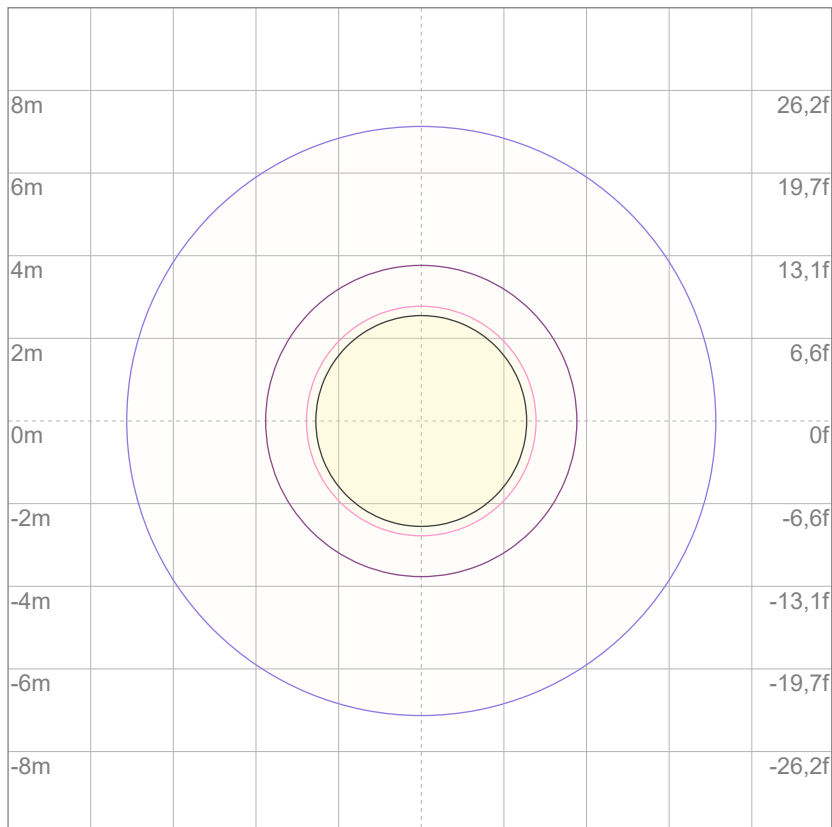

3%	58,2 lx
5%	97,0 lx
10%	194 lx
30%	582 lx
50%	970 lx

Conditions:

Number of c-planes: 2

Lux at center: 1939 lx

Lux distribution on a surface when lamp is mounted at 10 meters from the surface.



Peak candela output:

1226137 cd

Light quality:

CRI: 82,8

Color temperature:

6502 K

PRODUCT NAME:

ASTRAHYB420IP

MEASUREMENT CONDITIONS:

Beam angle:

Med Zoom

Target:

Full On

Operator:

Paolo Carvone

Date and time:

03/02/2021 17:38:40

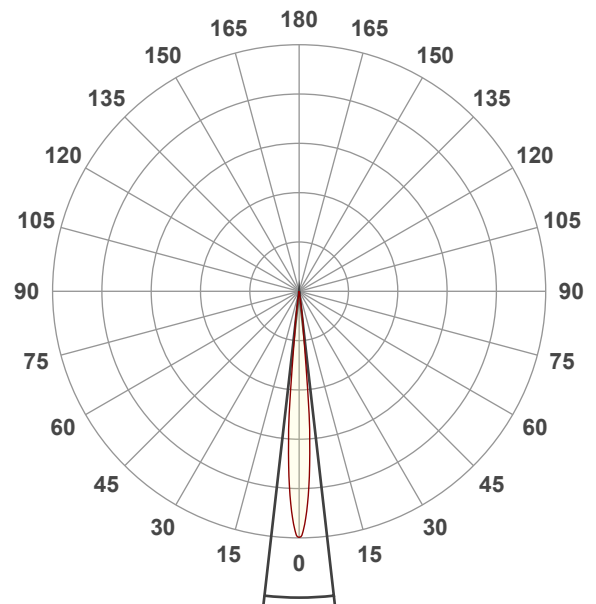

Beam angle 50%: 13°

Field angle 10%: 14,2°

Cut off angle 2.5%: 16,2°

Spectra

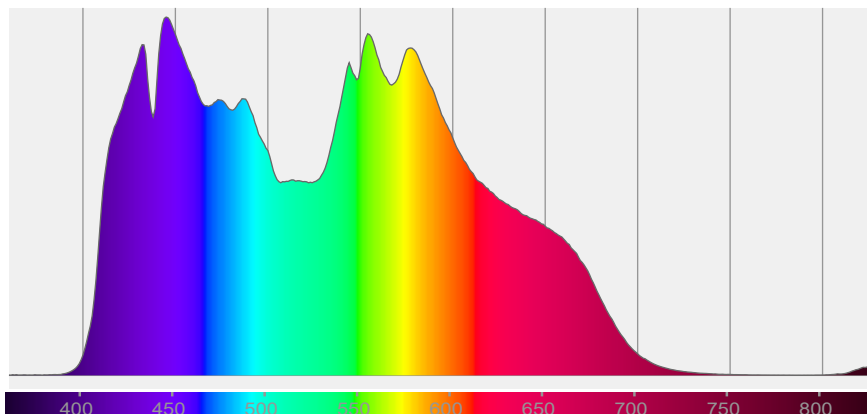

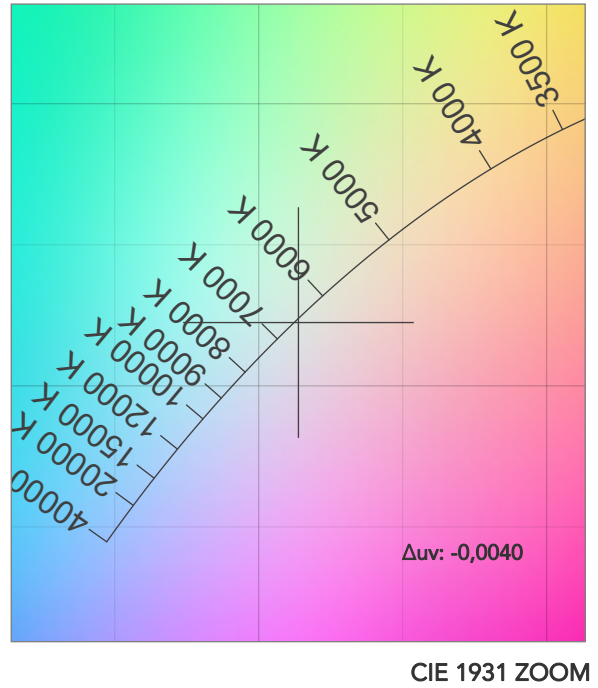
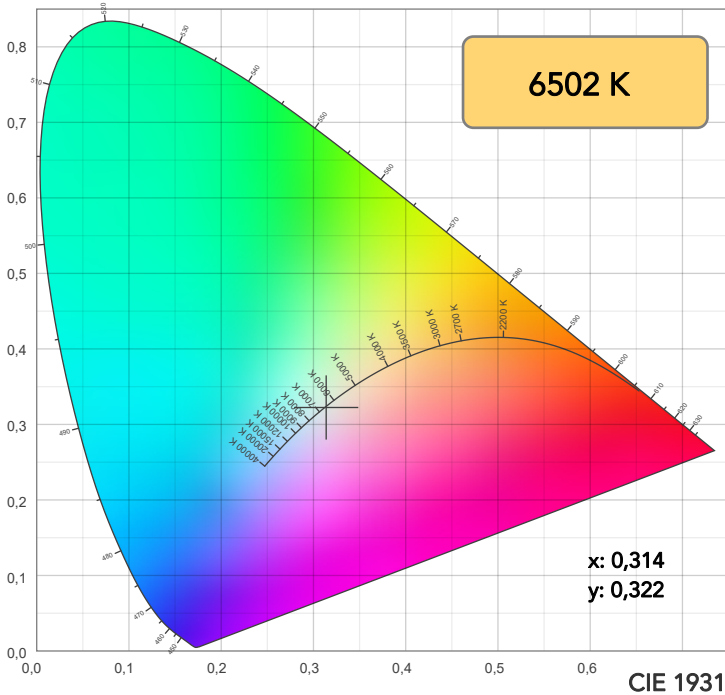

TM30: 84,6

CRI: 82,8 (R1-R8)

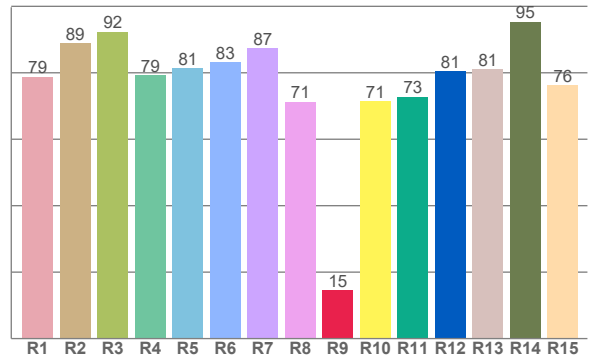
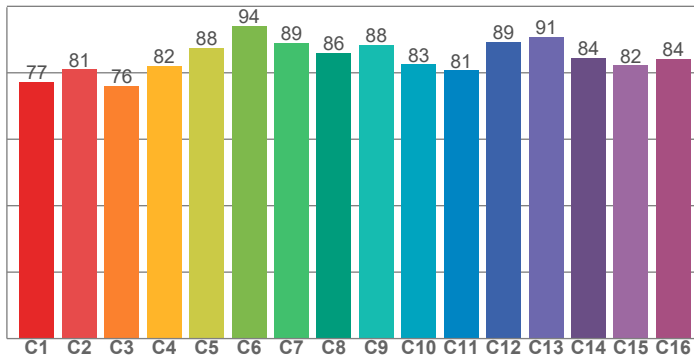

CRI R values, only R1-R8 are used to calculate final CRI value

R1	R2	R3	R4	R5	R6	R7	R8	R9	R10	R11	R12	R13	R14	R15
78,8	88,9	92,4	79,2	81,4	83,1	87,4	71,3	14,5	71,5	72,8	80,6	81,1	95,4	76,3

TM30 C values, 16 binned values out of total of 99 C values

C1	C2	C3	C4	C5	C6	C7	C8	C9	C10	C11	C12	C13	C14	C15	C16
77,2	81,1	76,0	82,0	87,6	94,0	89,1	85,9	88,3	82,5	80,8	89,4	90,9	84,4	82,3	84,3

CQS Q values

Q1	Q2	Q3	Q4	Q5	Q6	Q7	Q8	Q9	Q10	Q11	Q12	Q13	Q14	Q15
86,8	97,9	82,3	73,0	76,0	77,3	79,2	88,5	96,1	84,6	74,9	73,3	74,0	70,5	76,9

CQS: 79,1

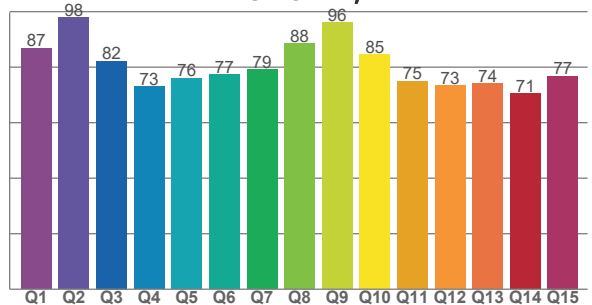

COLOR PARAMETERS

Color temperature	Color rendering index	Red component	Color fidelity	Color gamut	Color quality scale	Television lighting index	Color coordinate cie 1931	Color coordinate cie 1931	Color deviation from black body
CCT	CRI	CRI R9	TM30 Rf	TM30 Rg	CQS	TLCI	x	y	Δuv
6502 K	82,8	14,5	84,6	93,8	79,1	66	0,314	0,322	-0,0040

TM30 DETAILS

Rf 84,6
Fidelity index Rf

Rg 93,8
Gammut index

Hue Bin	R _f	Graphic shifts (%)	
		Chroma	Hue
1	77	-13%	0%
2	81	-9%	7%
3	76	-5%	13%
4	82	2%	11%
5	88	6%	6%
6	94	1%	-3%
7	89	-6%	-4%
8	86	-8%	-2%
9	88	-9%	5%
10	83	-5%	11%
11	81	0%	10%
12	89	4%	6%
13	91	6%	-2%
14	84	3%	-8%
15	82	-3%	-17%
16	84	-7%	-6%

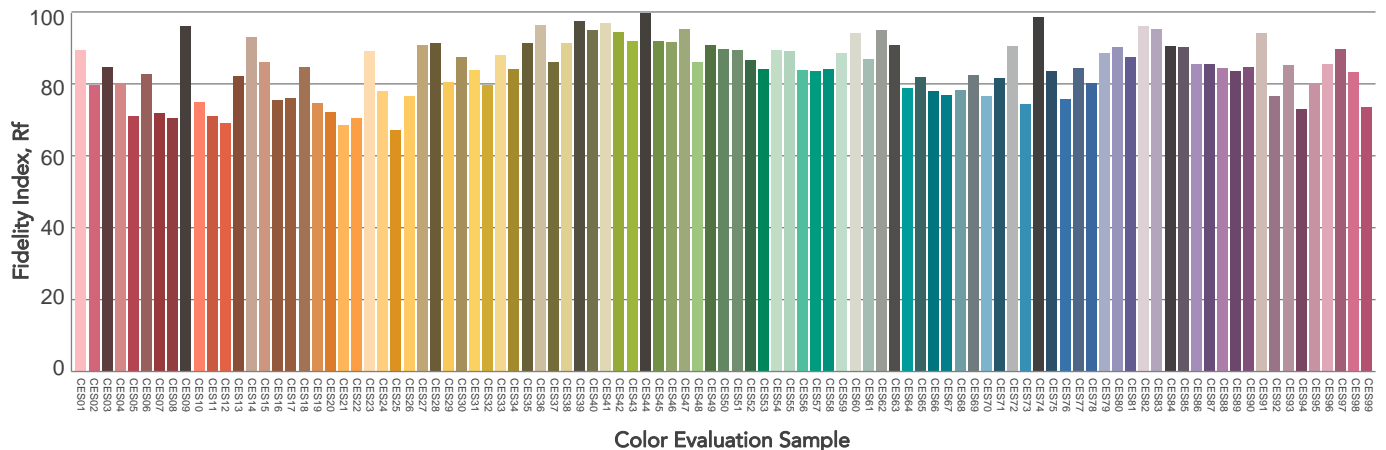
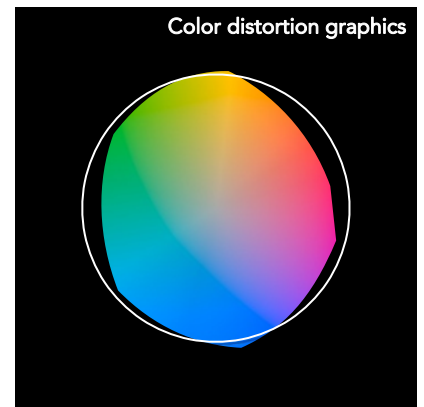
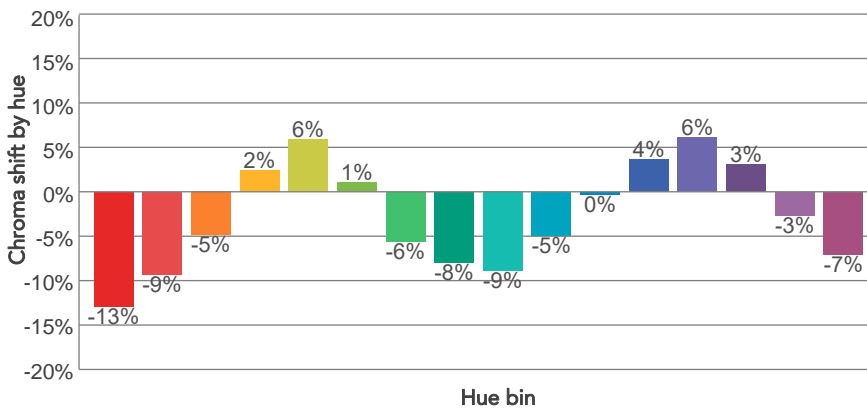
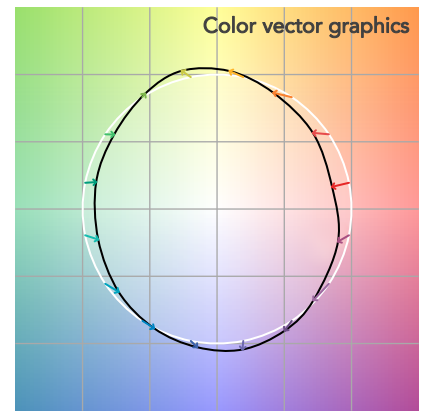
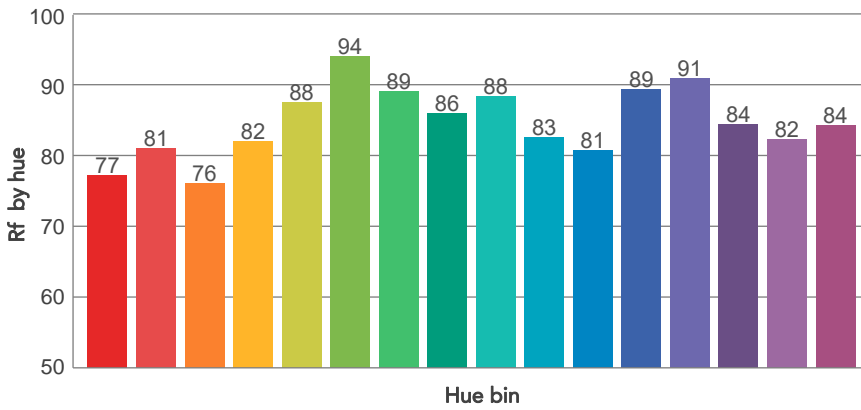
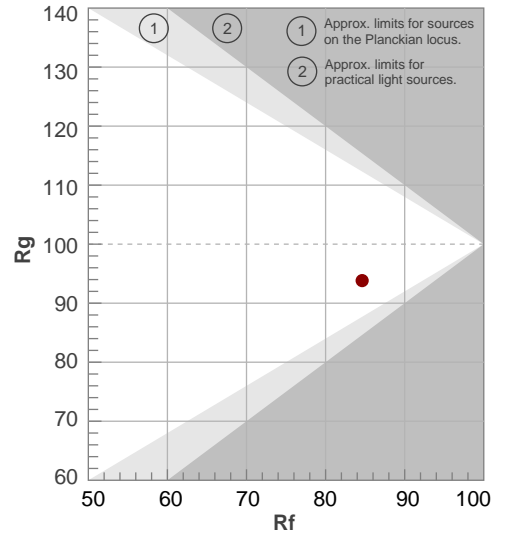

BEAM DETAILS



Beam angle 50%	Field angle 10%	Cut off angle 2,5%	Intensity ratio in 120° cone	Intensity ratio in 90° cone
13°	14,2°	16,2°	65,5%	53,2%

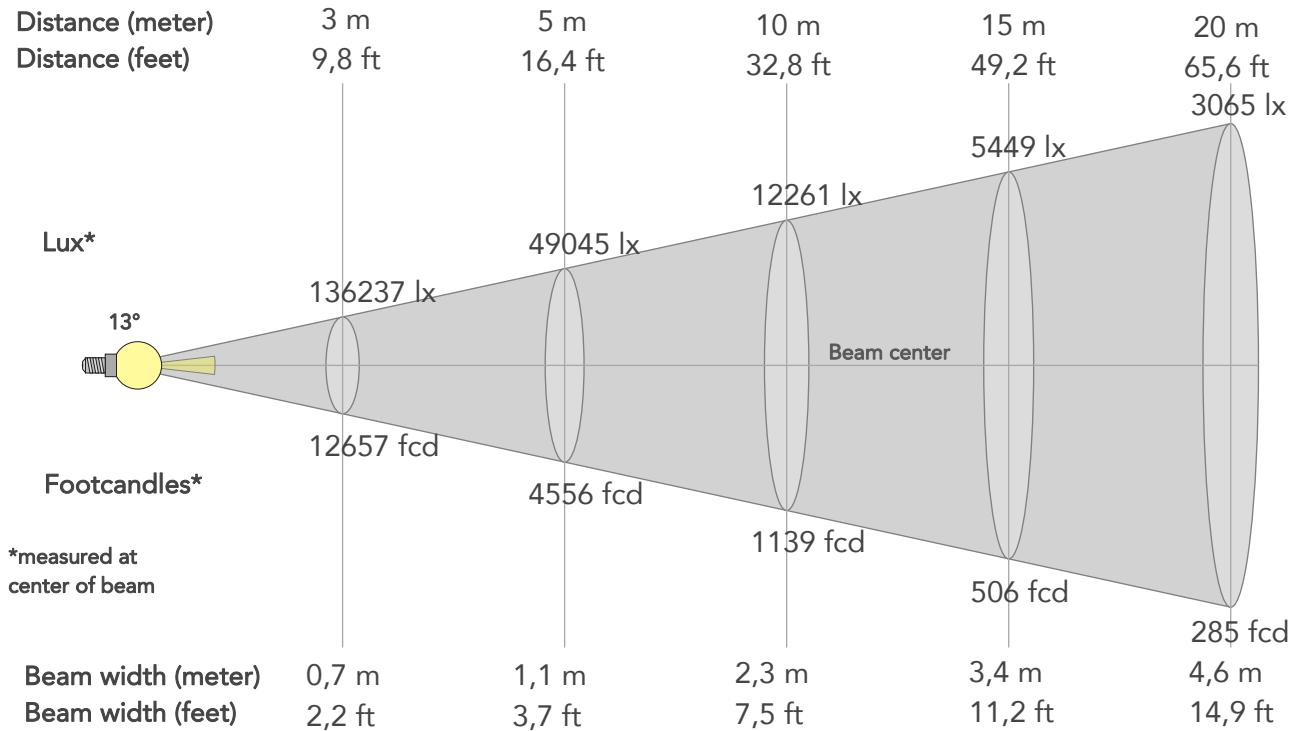

BEAM INTENSITIES AND WIDTHS

Distance	1m	2m	3m	4m	5m	7,5m	10m	15m	20m	25m	30m	40m	50m
Distance	3,3ft	6,6ft	9,8ft	13,1ft	16,4ft	24,6ft	32,8ft	49,2ft	65,6ft	82ft	98,4ft	131,2ft	164ft
Lux	1226136lx	306534lx	136237lx	76634lx	49045lx	21798lx	12261lx	5449lx	3065lx	1962lx	1362lx	766lx	490lx
Footcand.	113912fcd	28478fcd	12657fcd	7119fcd	4556fcd	2025fcd	1139fcd	506fcd	285fcd	182fcd	127fcd	71fcd	46fcd
Beam wid.	0,2m	0,5m	0,7m	0,9m	1,1m	1,7m	2,3m	3,4m	4,6m	5,7m	6,8m	9,1m	11,4m
Beam wid.	0,8ft	1,5ft	2,2ft	3ft	3,7ft	5,6ft	7,5ft	11,2ft	14,9ft	18,7ft	22,4ft	29,9ft	37,4ft

LINEAR DISTRIBUTION DIAGRAM

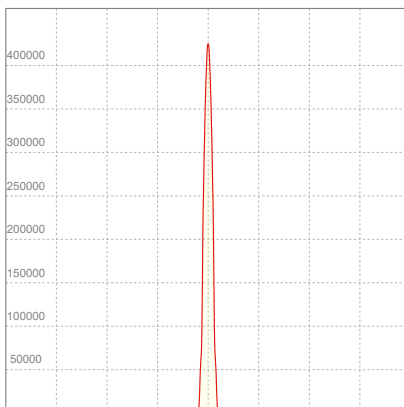

ELECTRICAL SPECIFICATIONS

Input voltage	Input current	Input power	Effeciency
226V	2,26A	491W	153lm/W
Power Fc			
0,96			

ISO CANDELA DIAGRAM

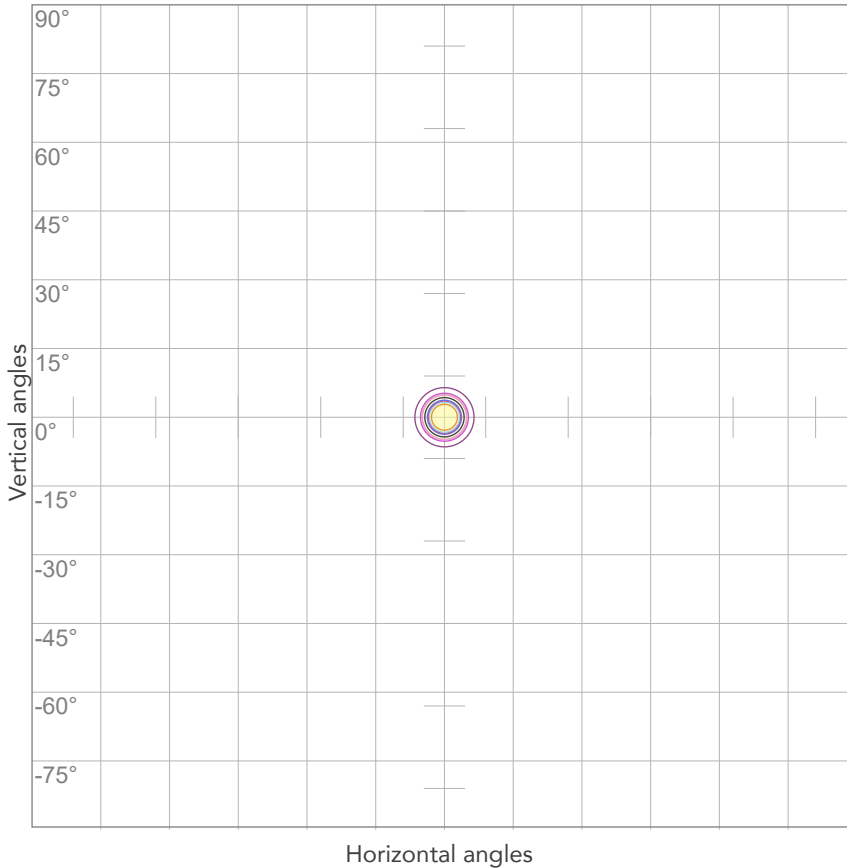

10%	122614 cd
20%	245227 cd
30%	367841 cd
40%	490455 cd
50%	613068 cd
60%	735682 cd
70%	858296 cd
80%	980909 cd

Conditions:

Number of c-planes: 2

Candela at center: 1226136 cd

ISO LUX DIAGRAM

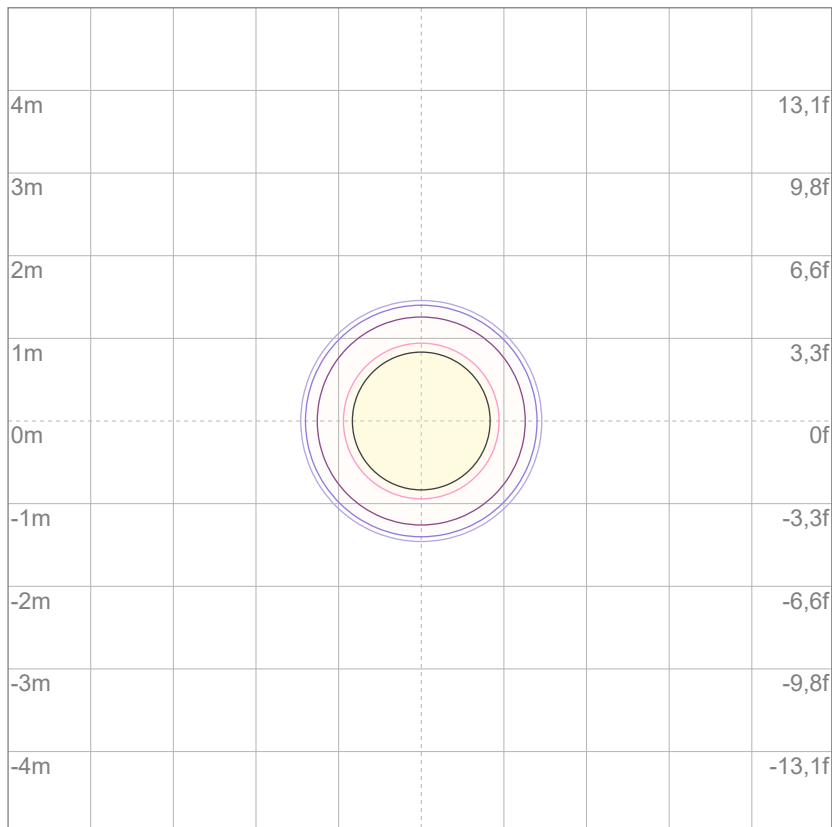

Mounting height: 10 meters (33 feet)

3%	368 lx
5%	613 lx
10%	1226 lx
30%	3678 lx
50%	6131 lx

Conditions:

Number of c-planes: 2

Lux at center: 12,3K lx

Lux distribution on a surface when lamp is mounted at 10 meters from the surface.



Peak candela output:

28651217 cd

Light quality:

CRI: 82,2

Color temperature:

6546 K

PRODUCT NAME:

ASTRAHYB420IP

MEASUREMENT CONDITIONS:

Beam angle:

Min Zoom

Target:

Full On

Operator:

Paolo Carvone

Date and time:

03/02/2021 17:28:21

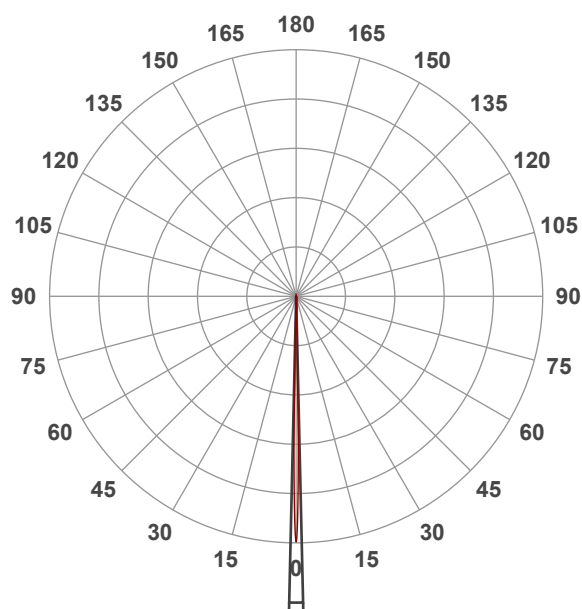

Beam angle 50%: 2,6°

Field angle 10%: 2,7°

Cut off angle 2.5%: 2,9°

Spectra

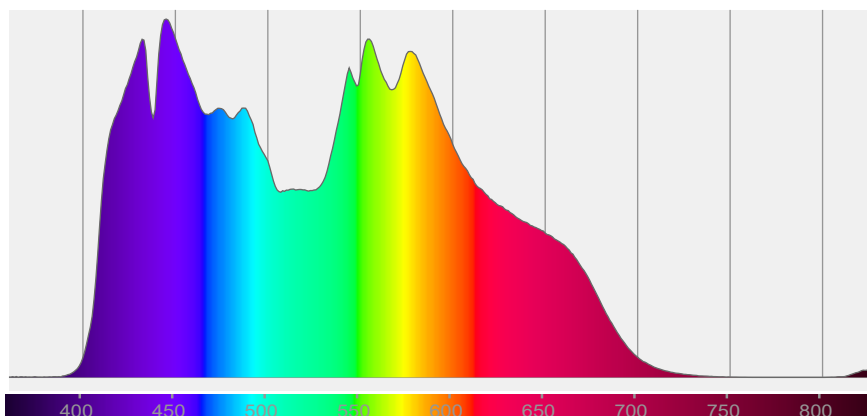

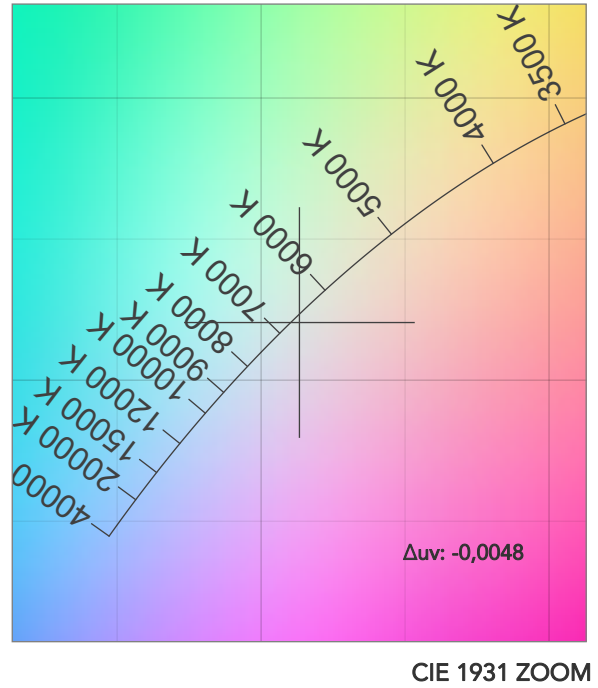
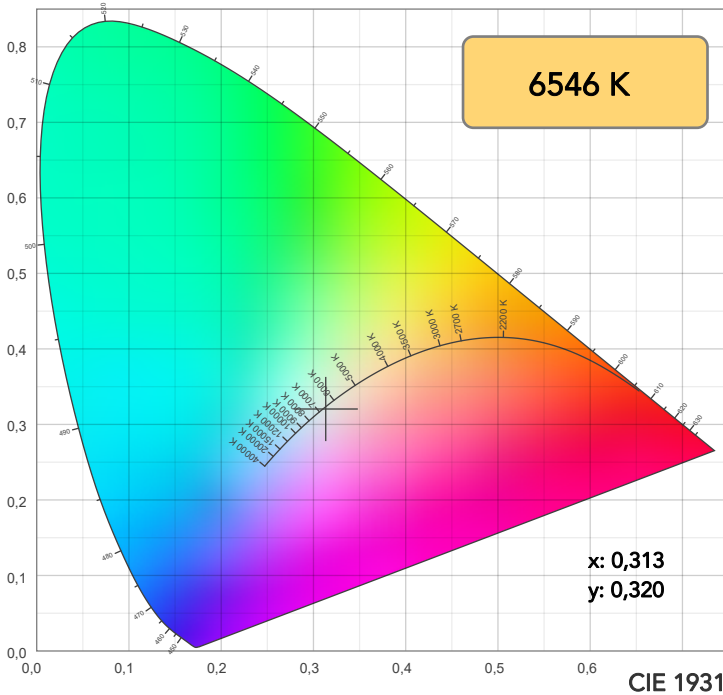

TM30: 83,8

CRI: 82,2 (R1-R8)

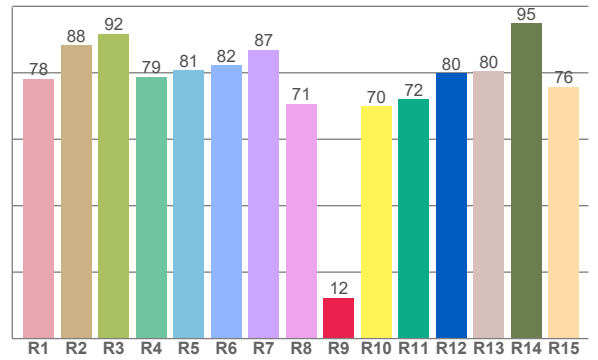
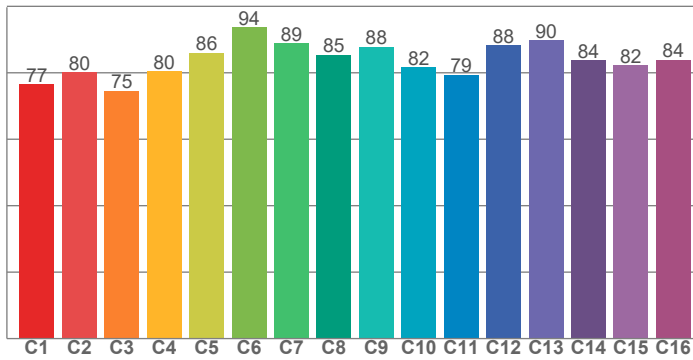

CRI R values, only R1-R8 are used to calculate final CRI value

R1	R2	R3	R4	R5	R6	R7	R8	R9	R10	R11	R12	R13	R14	R15
78,2	88,3	91,7	78,8	80,9	82,2	87,0	70,7	12,3	69,9	72,1	79,9	80,4	95,0	75,8

TM30 C values, 16 binned values out of total of 99 C values

C1	C2	C3	C4	C5	C6	C7	C8	C9	C10	C11	C12	C13	C14	C15	C16
76,5	80,1	74,5	80,4	86,0	93,7	88,8	85,5	87,8	81,7	79,4	88,2	89,7	83,8	82,2	83,9

CQS Q values

Q1	Q2	Q3	Q4	Q5	Q6	Q7	Q8	Q9	Q10	Q11	Q12	Q13	Q14	Q15
86,4	97,5	81,0	71,5	74,9	76,5	78,7	88,2	95,6	83,3	73,3	71,7	72,6	69,5	76,3

CQS: 78,1

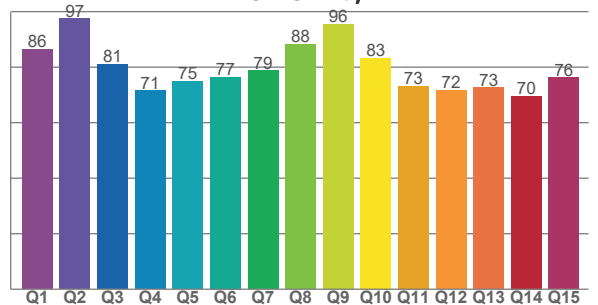

COLOR PARAMETERS

Color temperature	Color rendering index	Red component	Color fidelity	Color gamut	Color quality scale	Television lighting index	Color coordinate cie 1931	Color coordinate cie 1931	Color deviation from black body
CCT	CRI	CRI R9	TM30 Rf	TM30 Rg	CQS	TLCI	x	y	Δuv
6546 K	82,2	12,3	83,8	93,8	78,1	63	0,313	0,320	-0,0048

TM30 DETAILS

Rf 83,8
Fidelity index Rf

Rg 93,8
Gammut index

Hue Bin	R _f	Graphic shifts (%)	
		Chroma	Hue
1	77	-13%	0%
2	80	-10%	8%
3	75	-5%	14%
4	80	3%	12%
5	86	7%	6%
6	94	2%	-3%
7	89	-6%	-4%
8	85	-8%	-2%
9	88	-9%	5%
10	82	-5%	11%
11	79	0%	11%
12	88	4%	6%
13	90	7%	-2%
14	84	3%	-9%
15	82	-3%	-17%
16	84	-7%	-6%

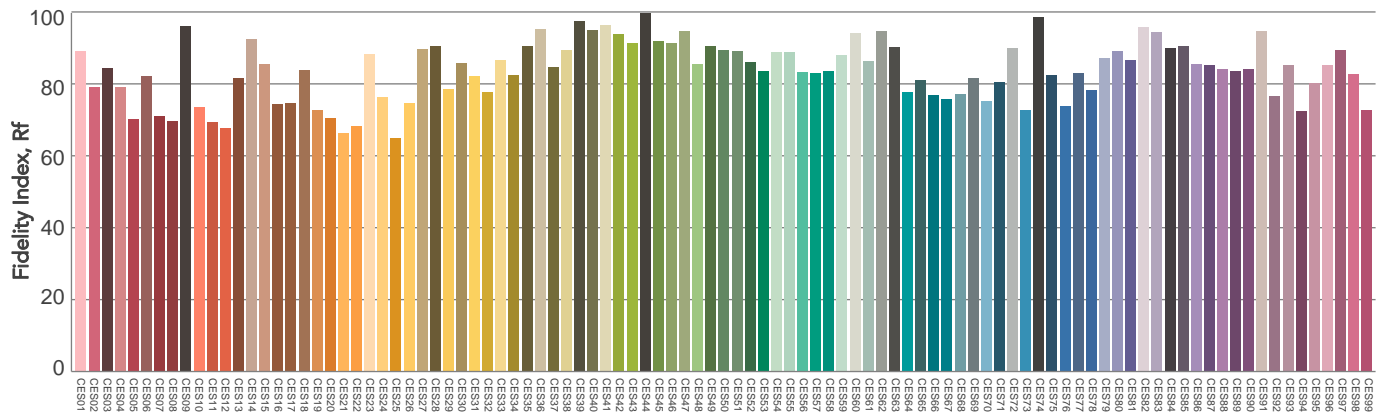
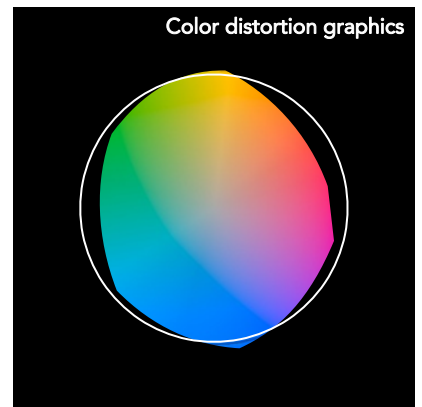
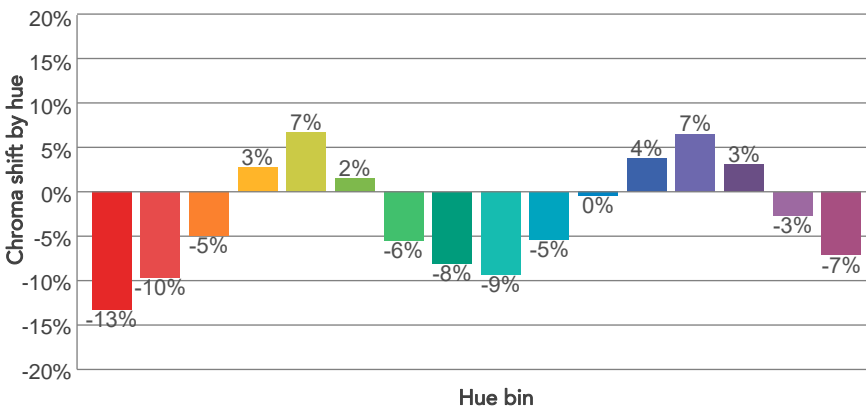
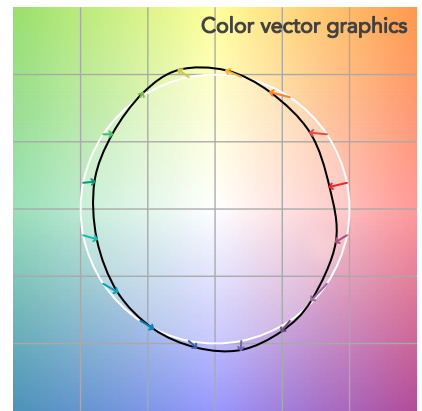
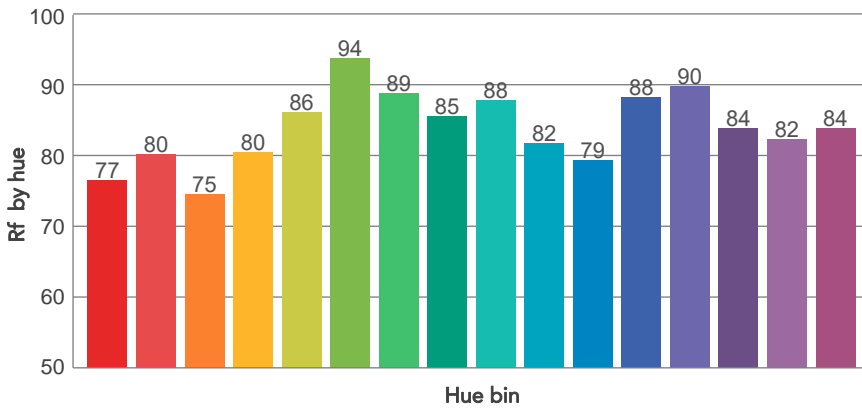
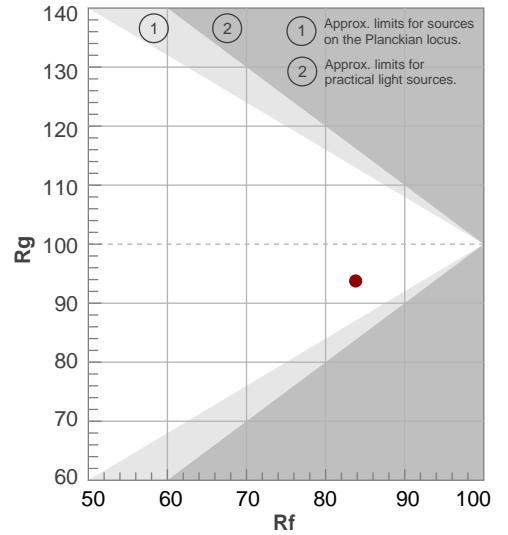

Color Evaluation Sample

BEAM DETAILS



Beam angle 50%	Field angle 10%	Cut off angle 2,5%	Intensity ratio in 120° cone	Intensity ratio in 90° cone
2,6°	2,7°	2,9°	88,8%	84,7%

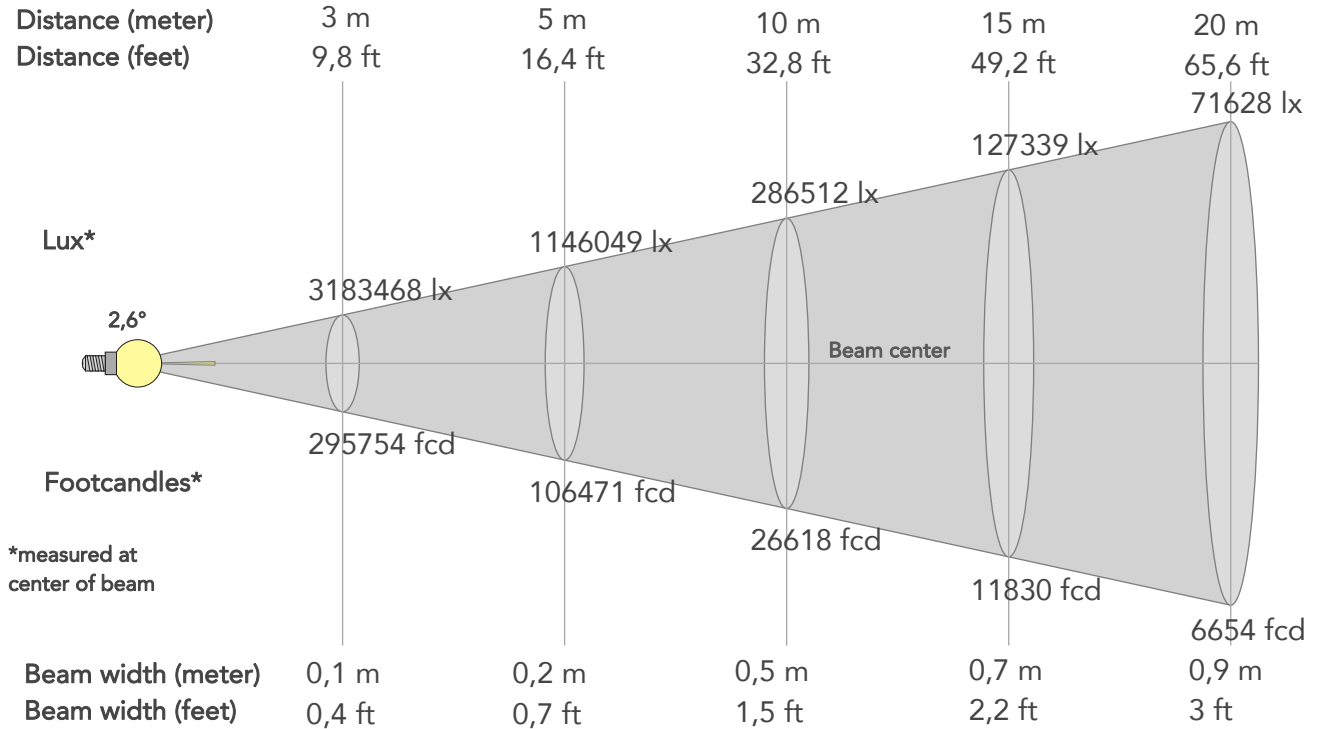

BEAM INTENSITIES AND WIDTHS

Distance	1m	2m	3m	4m	5m	7,5m	10m	15m	20m	25m	30m	40m	50m
Distance	3,3ft	6,6ft	9,8ft	13,1ft	16,4ft	24,6ft	32,8ft	49,2ft	65,6ft	82ft	98,4ft	131,2ft	164ft
Lux	28651215lx	7162804lx	3183468lx	1790701lx	1146049lx	509355lx	286512lx	127339lx	71628lx	45842lx	31835lx	17907lx	11460lx
Footcand.	2661785fcd	665446fcd	295754fcd	166362fcd	106471fcd	47321fcd	26618fcd	11830fcd	6654fcd	4259fcd	2958fcd	1664fcd	1065fcd
Beam wid.	0m	0,1m	0,1m	0,2m	0,2m	0,3m	0,5m	0,7m	0,9m	1,1m	1,4m	1,8m	2,3m
Beam wid.	0,1ft	0,3ft	0,4ft	0,6ft	0,7ft	1,1ft	1,5ft	2,2ft	3ft	3,7ft	4,5ft	6ft	7,4ft

LINEAR DISTRIBUTION DIAGRAM

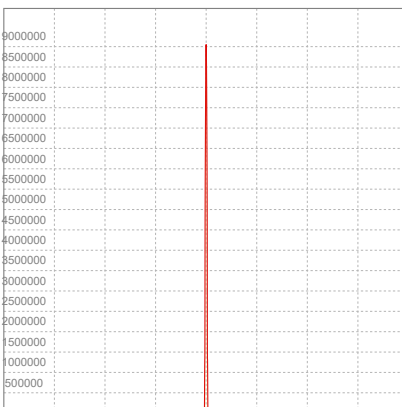

ELECTRICAL SPECIFICATIONS

Input voltage	Input current	Input power	Effeciency
221V	2,33A	495,9W	65lm/W
Power Fc			
0,96			

ISO CANDELA DIAGRAM

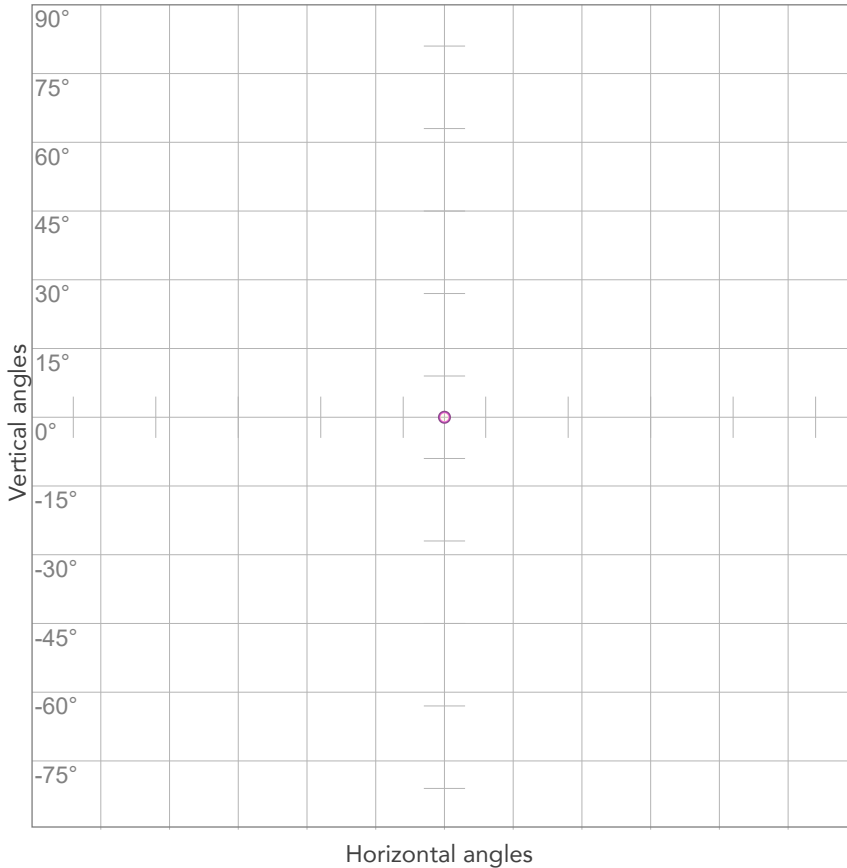

10%	2865121 cd
20%	5730243 cd
30%	8595364 cd
40%	11460486 cd
50%	14325607 cd
60%	17190729 cd
70%	20055850 cd
80%	22920972 cd

Conditions:
 Number of c-planes: 2
 Candela at center: 28651215 cd

ISO LUX DIAGRAM

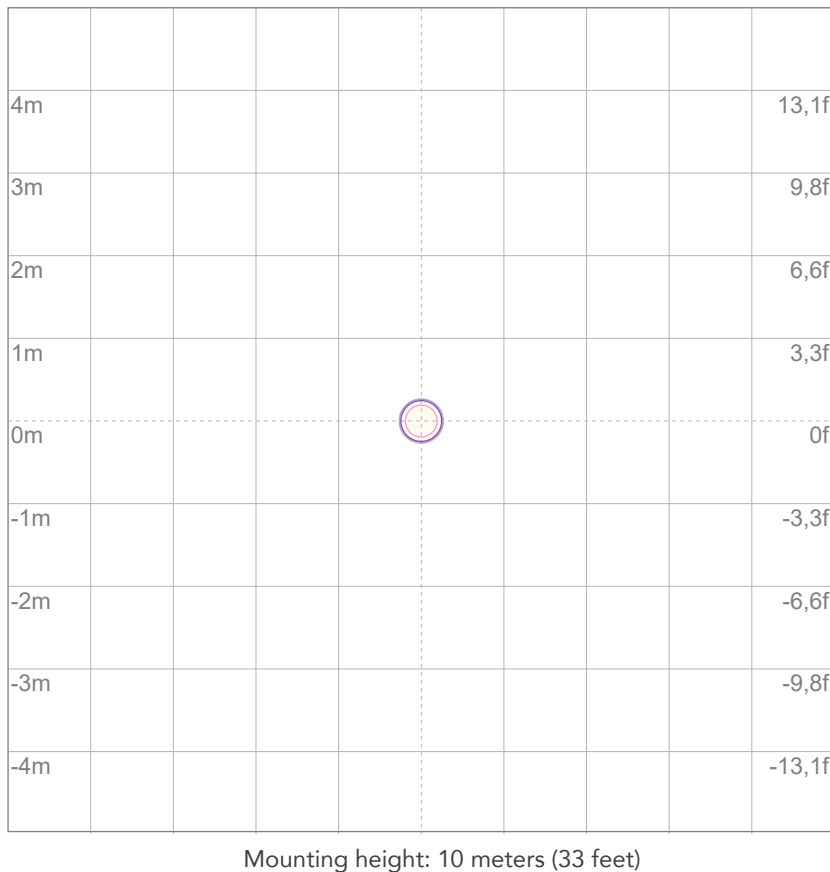

3%	8595 lx
5%	14,3K lx
10%	28,7K lx
30%	86,0K lx
50%	143K lx

Conditions:
 Number of c-planes: 2
 Lux at center: 287K lx

Lux distribution on a surface when lamp is mounted at 10 meters from the surface.