

Photometric Test Report



ArcSpot XLFC

IP66 Spot featuring 11'600 lumen
with 61 x 4W RGB + Warm White source,
15° Lens

CONTENTS

Table of contents	2
Testing process	3
Color preset Full on	4
Color preset Red	7
Color preset Green	10
Color preset Blue	13
Color preset White	16
Color preset 2800K	21
Color preset 3200K	26
Color preset 4000K	31
Color preset 5600K	36
Color preset 6000K	41

TESTING PROCESS

Prolights has its own optical testing laboratory in order to provide accurate photometric reports for its lighting products. The testing laboratory contains certain variety of precise lighting measurement systems that ensure an optimal reading of all the characteristic parameters of the lighting devices. All measurements are made at a controlled room temperature of 20°C without any external light sources. This photometric report is obtained through the data measured by a high precision measurement system and analyzed by a dedicate software.

Prolights measurement instrument

Prolights measurement instrument is a complete measurement system for any light source. It's equipped with two-axis goniometer, that enables to measure the full 3D distribution field of the light source. This instrument measures the light intensity, the beam angle and the most significative colors parameters, like color temperature, spectral distribution, CRI, CQS, TM-30 with a very high accuracy rate.

Please Note: All measurements are made with light source at operating temperature. Before starting the measurement, the instrument analyzes the process of the light source during the heating phase. The measuring process of all the parameters begins only when the light emission is stable, that is with a variation of less than 0.5% in a 15 minutes time frame.

Prolights measurement software

The software provides user friendly interface for the operator who does the measurements, and it also analyzes and processes all the collected data by the instrument. With this software it is possible to see the measured data in real-time and it is possible to examine all the measured data and graphics afterwards as well. All information is collected in a specific Prolights template, and the software creates also IES and LDT files, which are widely used to transfer the photometric data, and to develop lighting system.

Additionally, the fixtures are rechecked using various hand-held instruments like Sekonic C-700 and Gossen Mavospec Base, this is done to ensure, that the data in the photometric report are as accurate as possible.



Total lumen output:

11061 lm

Peak candela output:

121063 cd

PRODUCT NAME:

ARCSPOTXLFC

MEASURAMENT CONDITIONS:

Beam angle:

15Deg Optic

Target:

Full On

Operator:

Salvatore Giglio

Date and time:

04/11/2024 17:26:35

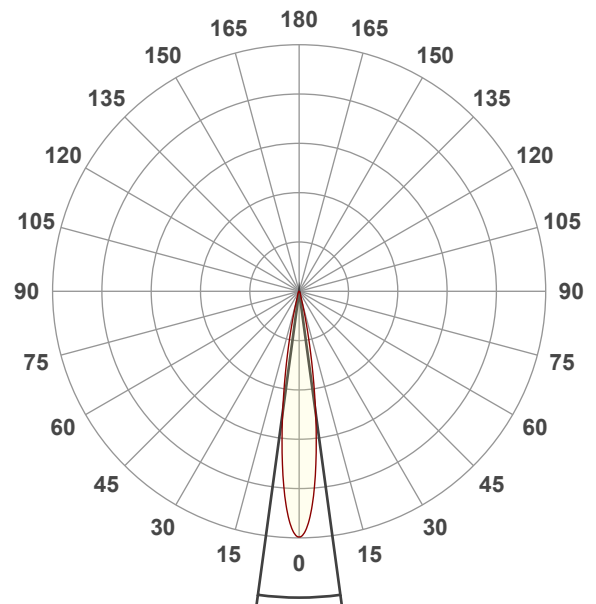

Beam angle 50%: 15,5°

Field angle 10%: 26,7°

Cut off angle 2.5%: 36,3°

Spectra

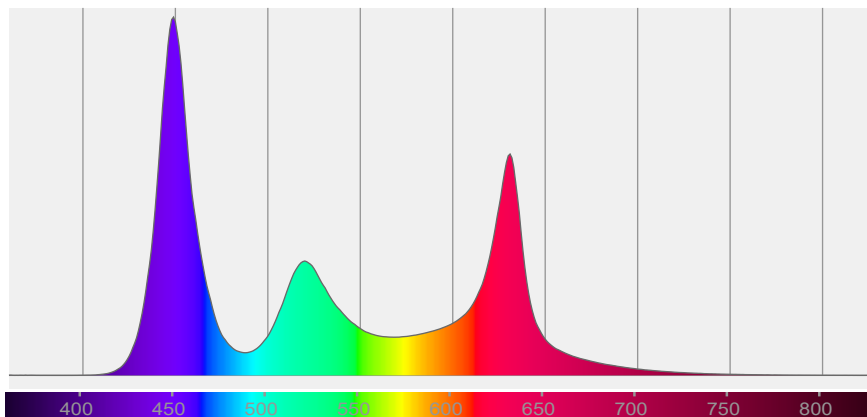

BEAM DETAILS



Beam angle 50%	Field angle 10%	Cut off angle 2,5%	Intensity ratio in 120° cone	Intensity ratio in 90° cone
15,5°	26,7°	36,3°	99,3%	97,0%

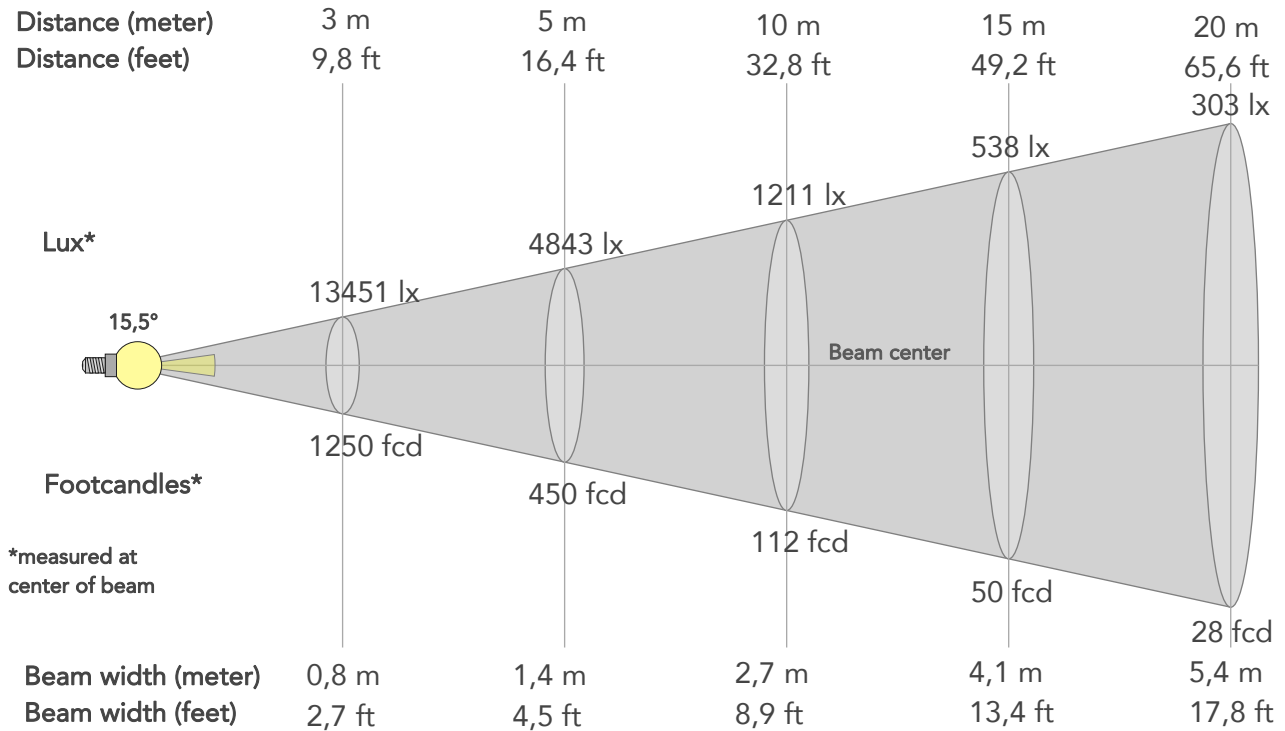

BEAM INTENSITIES AND WIDTHS

Distance	1m	2m	3m	4m	5m	7,5m	10m	15m	20m	25m	30m	40m	50m
Distance	3,3ft	6,6ft	9,8ft	13,1ft	16,4ft	24,6ft	32,8ft	49,2ft	65,6ft	82ft	98,4ft	131,2ft	164ft
Lux	121063lx	30266lx	13451lx	7566lx	4843lx	2152lx	1211lx	538lx	303lx	194lx	135lx	76lx	48lx
Footcand.	11247fcd	2812fcd	1250fcd	703fcd	450fcd	200fcd	112fcd	50fcd	28fcd	18fcd	12fcd	7fcd	4fcd
Beam wid.	0,3m	0,5m	0,8m	1,1m	1,4m	2m	2,7m	4,1m	5,4m	6,8m	8,2m	10,9m	13,6m
Beam wid.	0,9ft	1,8ft	2,7ft	3,6ft	4,5ft	6,7ft	8,9ft	13,4ft	17,8ft	22,3ft	26,7ft	35,7ft	44,6ft

LINEAR DISTRIBUTION DIAGRAM

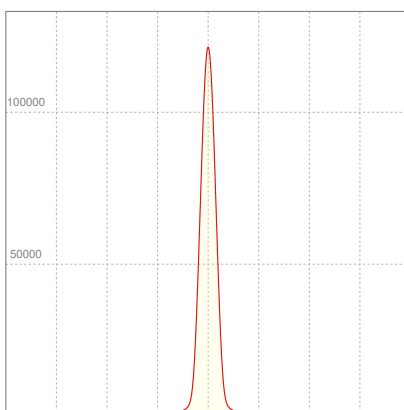

ELECTRICAL SPECIFICATIONS

Input voltage	Input current	Input power	Power FC	Efficiency
226V	1,01A	215,4W	0,94	51lm/W

ISO DIAGRAMS

ISO CANDELA DIAGRAM

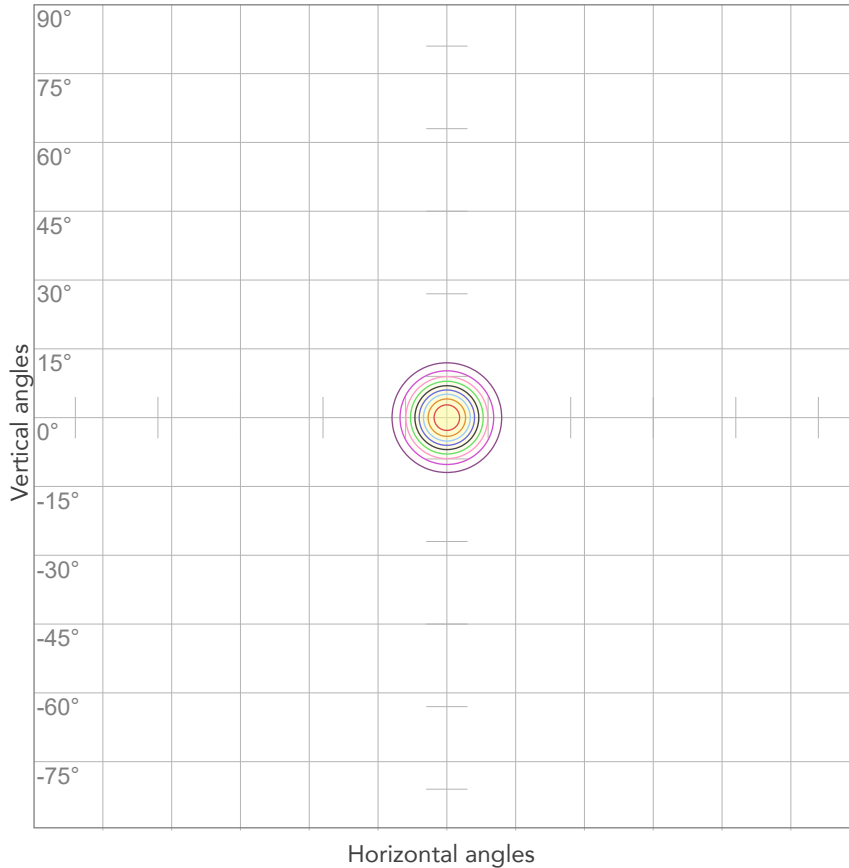

10%	12106 cd
20%	24213 cd
30%	36319 cd
40%	48425 cd
50%	60532 cd
60%	72638 cd
70%	84744 cd
80%	96850 cd

Conditions:

Number of c-planes: 2

Candela at center: 121063 cd

ISO LUX DIAGRAM

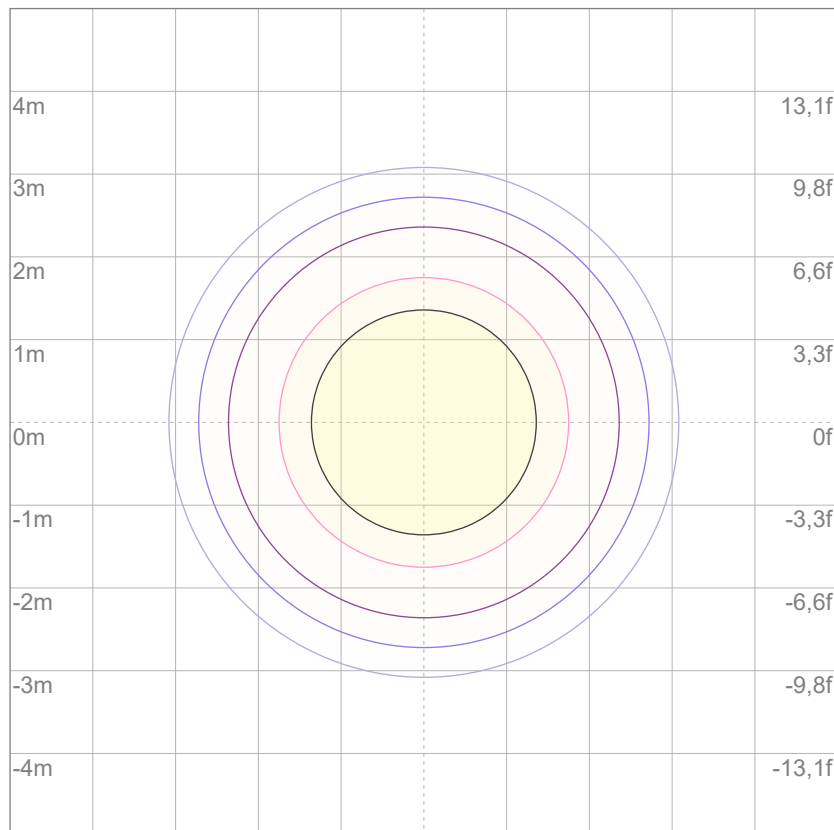

Mounting height: 10 meters (33 feet)

3%	36,3 lx
5%	60,5 lx
10%	121 lx
30%	363 lx
50%	605 lx

Conditions:

Number of c-planes: 2

Lux at center: 1211 lx

Lux distribution on a surface when lamp is mounted at 10 meters from the surface.



Total lumen output:

3542 lm

Peak candela output:

38590 cd

PRODUCT NAME:

ARCSPOTXLFC

MEASUREMENT CONDITIONS:

Beam angle:

15Deg Optic

Target:

Red

Operator:

Salvatore Giglio

Date and time:

04/11/2024 17:39:55

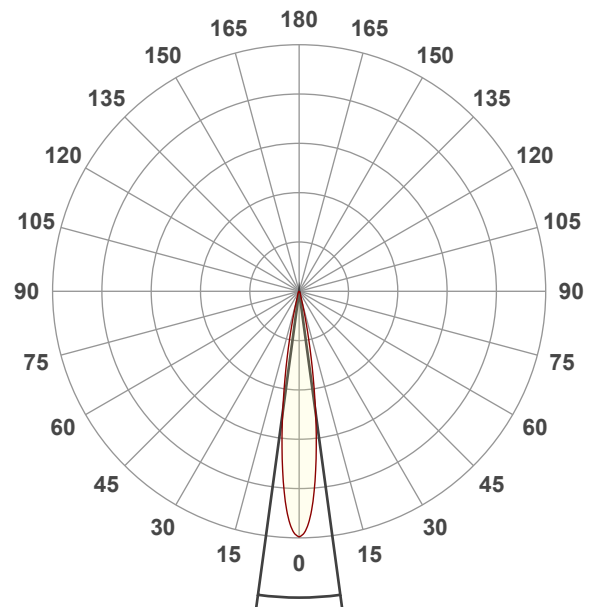

Beam angle 50%: 15,5°

Field angle 10%: 26,4°

Cut off angle 2.5%: 36,2°

Spectra

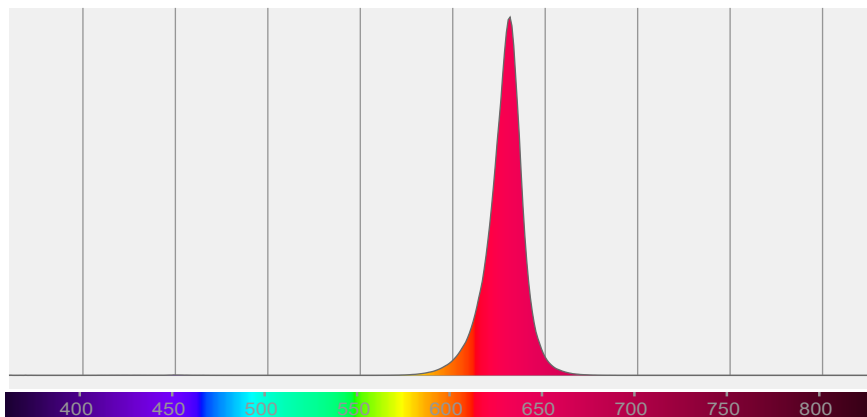

BEAM DETAILS



Beam angle 50%	Field angle 10%	Cut off angle 2,5%	Intensity ratio in 120° cone	Intensity ratio in 90° cone
15,5°	26,4°	36,2°	98,7%	95,9%

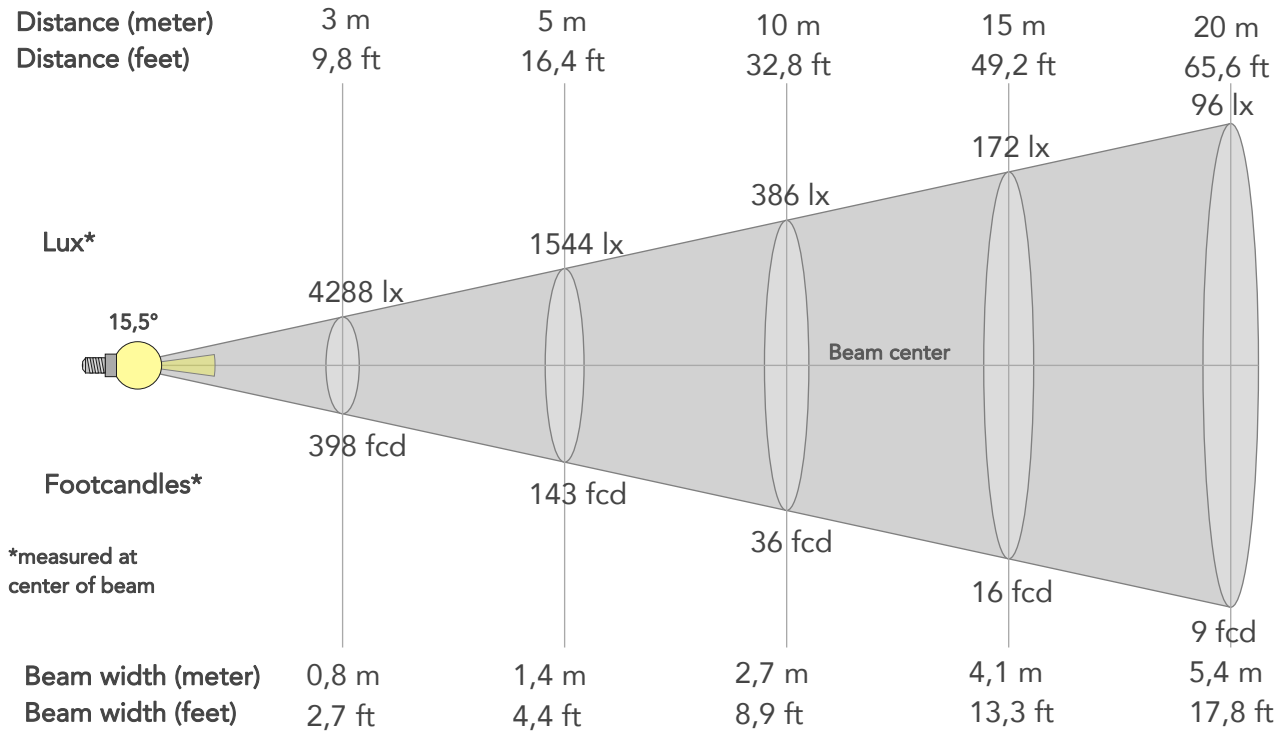

BEAM INTENSITIES AND WIDTHS

Distance	1m	2m	3m	4m	5m	7,5m	10m	15m	20m	25m	30m	40m	50m
Distance	3,3ft	6,6ft	9,8ft	13,1ft	16,4ft	24,6ft	32,8ft	49,2ft	65,6ft	82ft	98,4ft	131,2ft	164ft
Lux	38590lx	9647lx	4288lx	2412lx	1544lx	686lx	386lx	172lx	96lx	62lx	43lx	24lx	15lx
Footcand.	3585fcd	896fcd	398fcd	224fcd	143fcd	64fcd	36fcd	16fcd	9fcd	6fcd	4fcd	2fcd	1fcd
Beam wid.	0,3m	0,5m	0,8m	1,1m	1,4m	2m	2,7m	4,1m	5,4m	6,8m	8,1m	10,9m	13,6m
Beam wid.	0,9ft	1,8ft	2,7ft	3,6ft	4,4ft	6,7ft	8,9ft	13,3ft	17,8ft	22,2ft	26,7ft	35,6ft	44,5ft

LINEAR DISTRIBUTION DIAGRAM

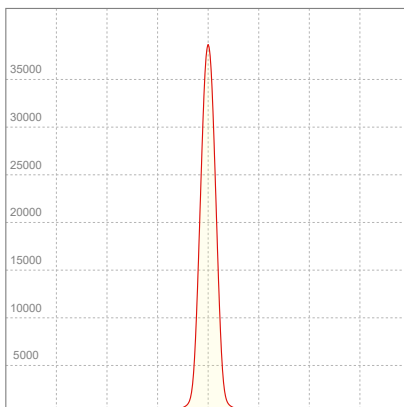

ELECTRICAL SPECIFICATIONS

Input voltage	Input current	Input power	Power FC	Efficiency
226V	0,477A	81,3W	0,75	44lm/W

ISO DIAGRAMS

ISO CANDELA DIAGRAM

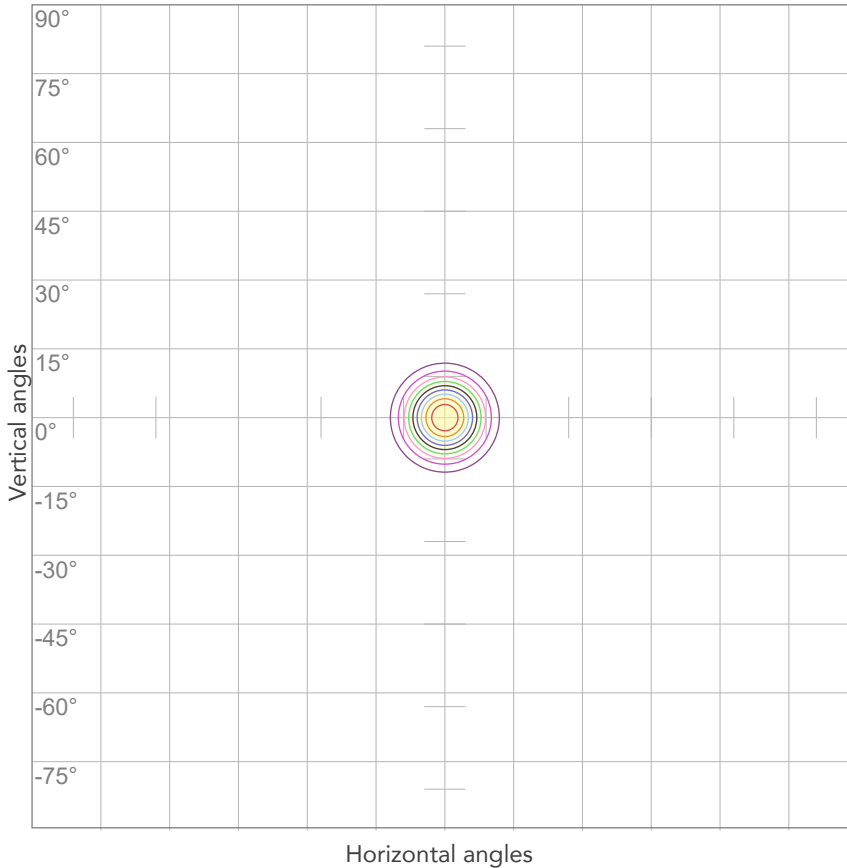

10%	3859 cd
20%	7718 cd
30%	11577 cd
40%	15436 cd
50%	19295 cd
60%	23154 cd
70%	27013 cd
80%	30872 cd

Conditions:

Number of c-planes: 2

Candela at center: 38590 cd

ISO LUX DIAGRAM

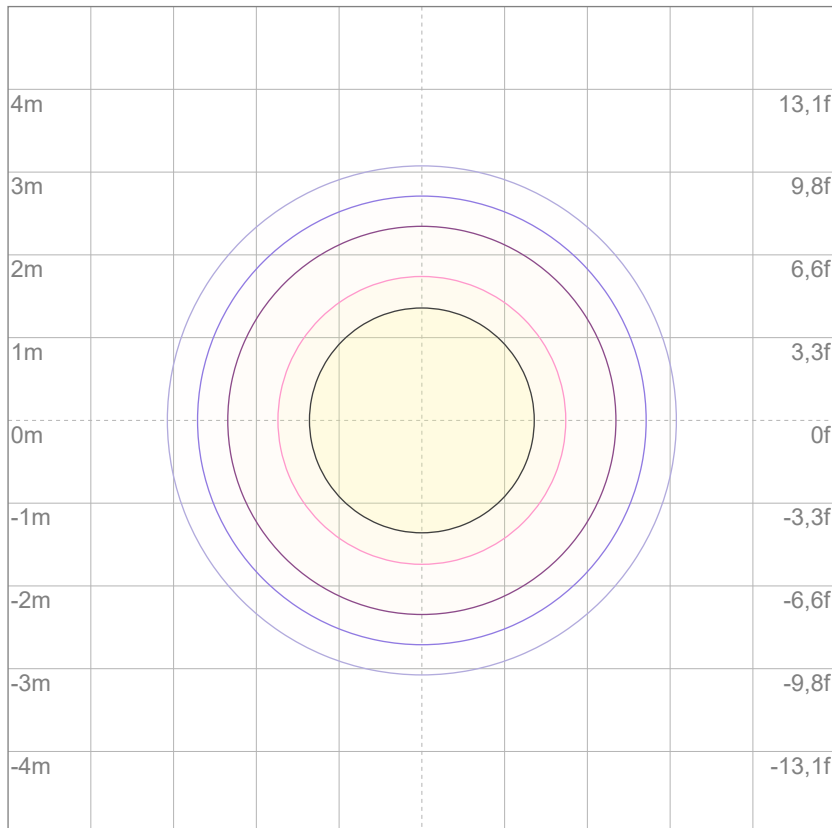

3%	11,6 lx
5%	19,3 lx
10%	38,6 lx
30%	116 lx
50%	193 lx

Conditions:

Number of c-planes: 2

Lux at center: 386 lx

Lux distribution on a surface when lamp is mounted at 10 meters from the surface.

Mounting height: 10 meters (33 feet)



Total lumen output:

7467 lm

Peak candela output:

80172 cd

PRODUCT NAME:

ARCSPOTXLFC

MEASURAMENT CONDITIONS:

Beam angle:

15Deg Optic

Target:

Green

Operator:

Salvatore Giglio

Date and time:

04/11/2024 17:41:28

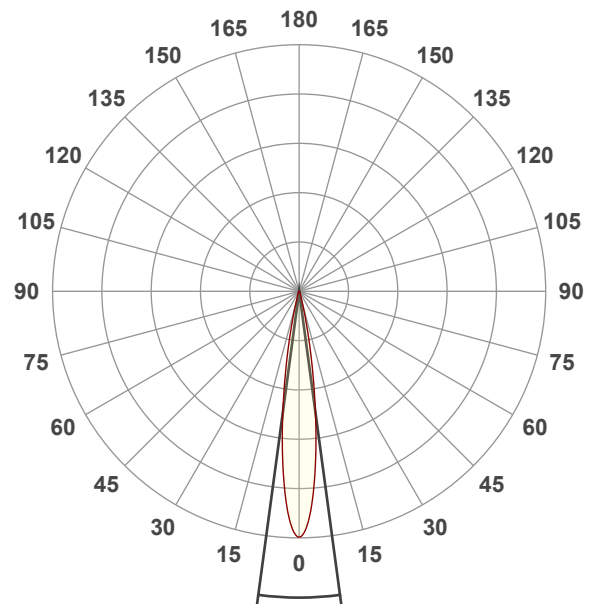

Beam angle 50%: 15,3°

Field angle 10%: 26,8°

Cut off angle 2.5%: 36,5°

Spectra

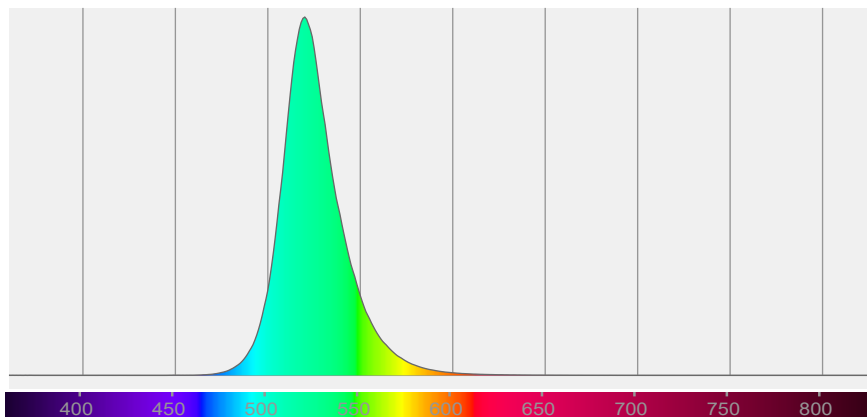

BEAM DETAILS



Beam angle 50%	Field angle 10%	Cut off angle 2,5%	Intensity ratio in 120° cone	Intensity ratio in 90° cone
15,3°	26,8°	36,5°	98,5%	95,5%

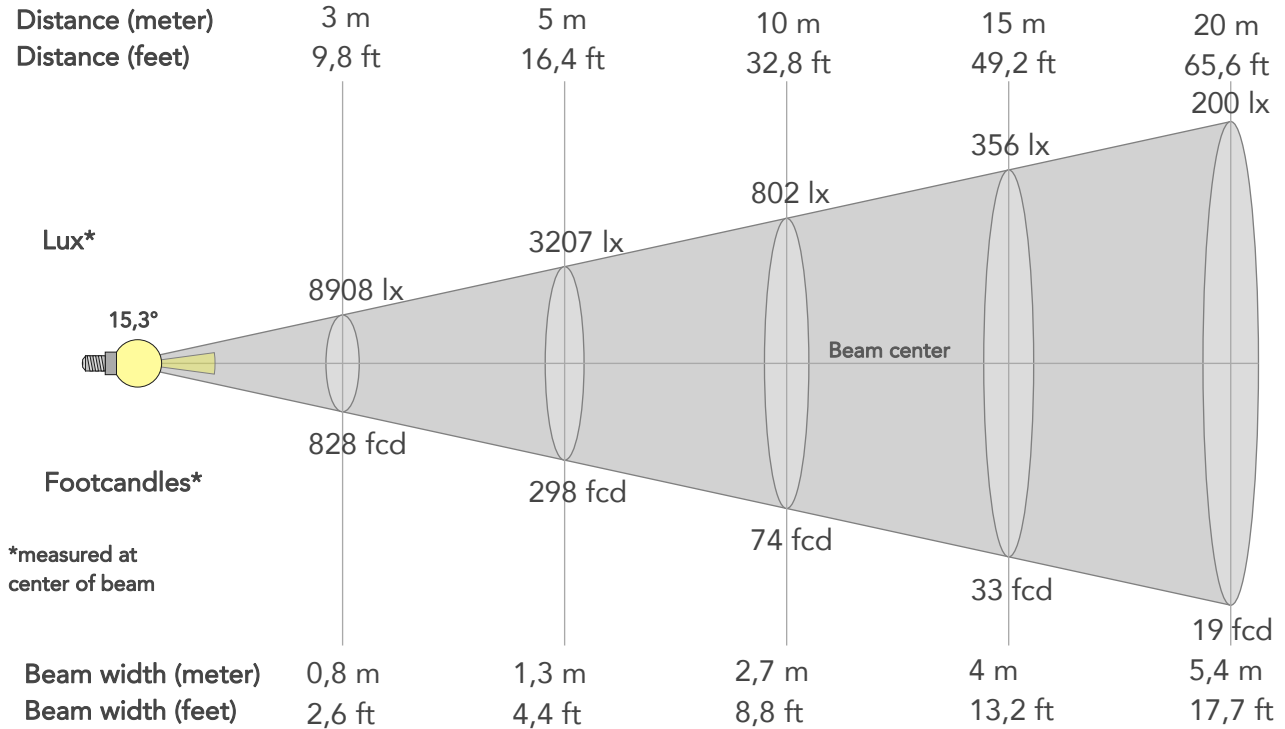

BEAM INTENSITIES AND WIDTHS

Distance	1m	2m	3m	4m	5m	7,5m	10m	15m	20m	25m	30m	40m	50m
Distance	3,3ft	6,6ft	9,8ft	13,1ft	16,4ft	24,6ft	32,8ft	49,2ft	65,6ft	82ft	98,4ft	131,2ft	164ft
Lux	80172lx	20043lx	8908lx	5011lx	3207lx	1425lx	802lx	356lx	200lx	128lx	89lx	50lx	32lx
Footcand.	7448fcd	1862fcd	828fcd	466fcd	298fcd	132fcd	74fcd	33fcd	19fcd	12fcd	8fcd	5fcd	3fcd
Beam wid.	0,3m	0,5m	0,8m	1,1m	1,3m	2m	2,7m	4m	5,4m	6,7m	8,1m	10,8m	13,5m
Beam wid.	0,9ft	1,8ft	2,6ft	3,5ft	4,4ft	6,6ft	8,8ft	13,2ft	17,7ft	22,1ft	26,5ft	35,3ft	44,1ft

LINEAR DISTRIBUTION DIAGRAM

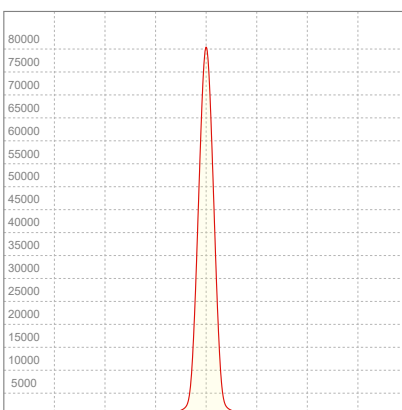

ELECTRICAL SPECIFICATIONS

Input voltage	Input current	Input power	Power FC	Efficiency
226V	0,553A	101,9W	0,82	73lm/W

ISO DIAGRAMS

ISO CANDELA DIAGRAM

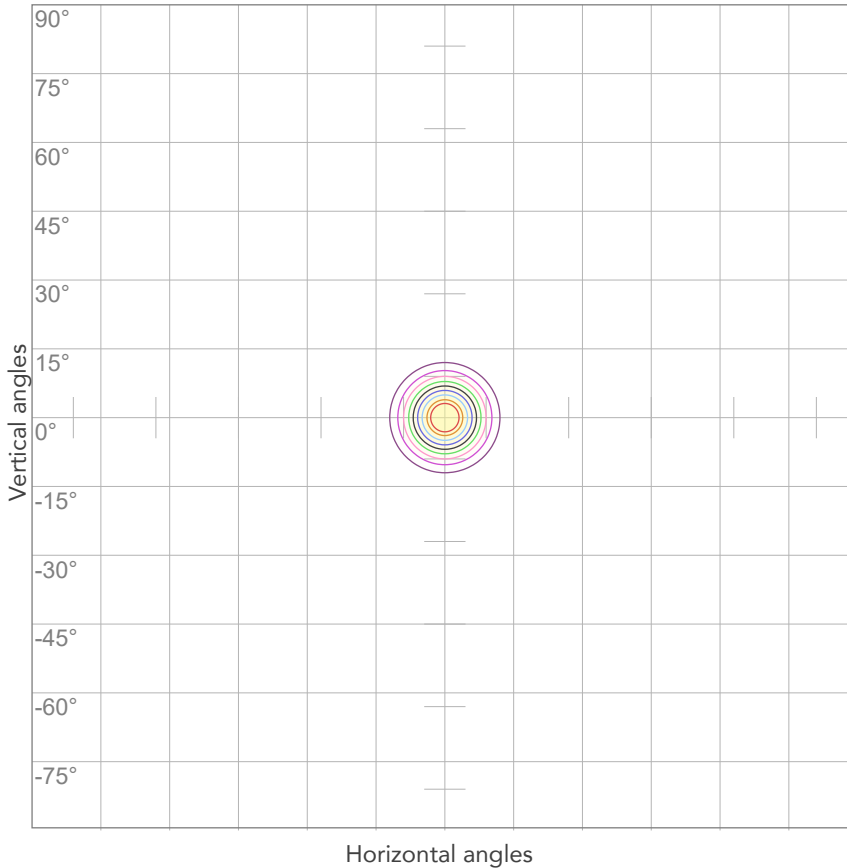

10%	8017 cd
20%	16034 cd
30%	24052 cd
40%	32069 cd
50%	40086 cd
60%	48103 cd
70%	56120 cd
80%	64137 cd

Conditions:

Number of c-planes: 2

Candela at center: 80172 cd

ISO LUX DIAGRAM

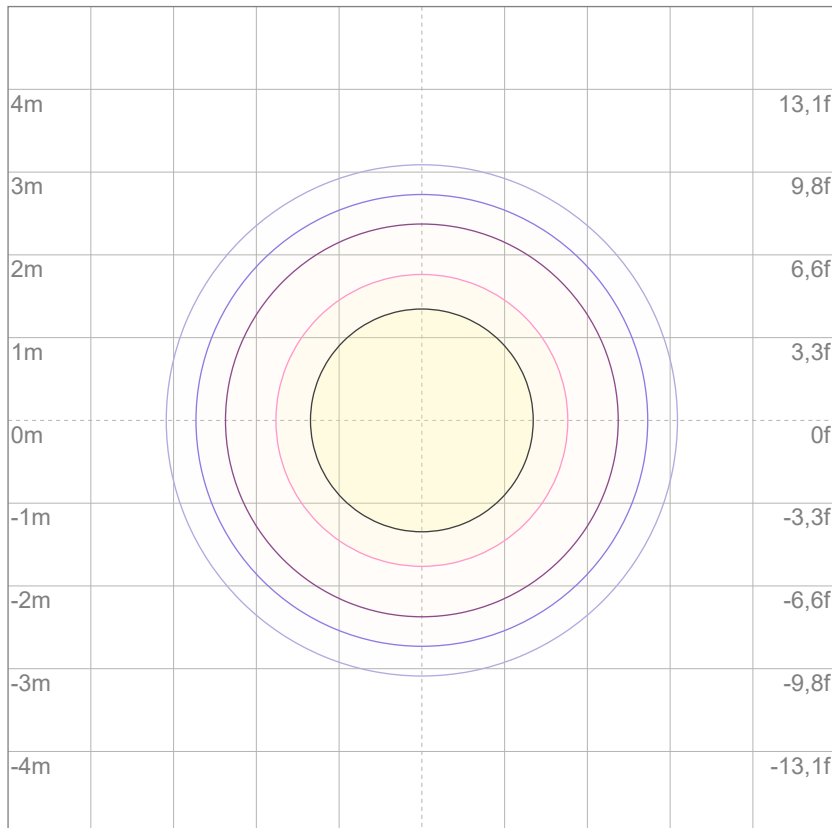

3%	24,1 lx
5%	40,1 lx
10%	80,2 lx
30%	241 lx
50%	401 lx

Conditions:

Number of c-planes: 2

Lux at center: 802 lx

Lux distribution on a surface when lamp is mounted at 10 meters from the surface.

Mounting height: 10 meters (33 feet)



Total lumen output:

1387 lm

Peak candela output:

14954 cd

PRODUCT NAME:

ARCSPOTXLFC

MEASURAMENT CONDITIONS:

Beam angle:

15Deg Optic

Target:

Blue

Operator:

Salvatore Giglio

Date and time:

04/11/2024 17:43:00

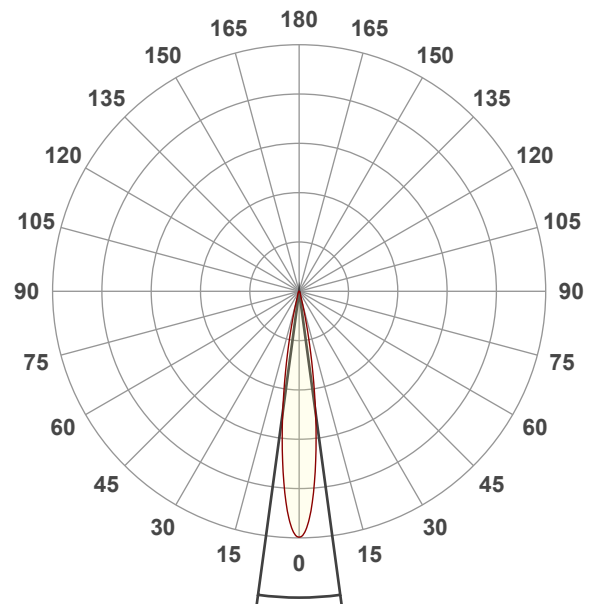

Beam angle 50%: 15,4°

Field angle 10%: 26,9°

Cut off angle 2.5%: 36,1°

Spectra

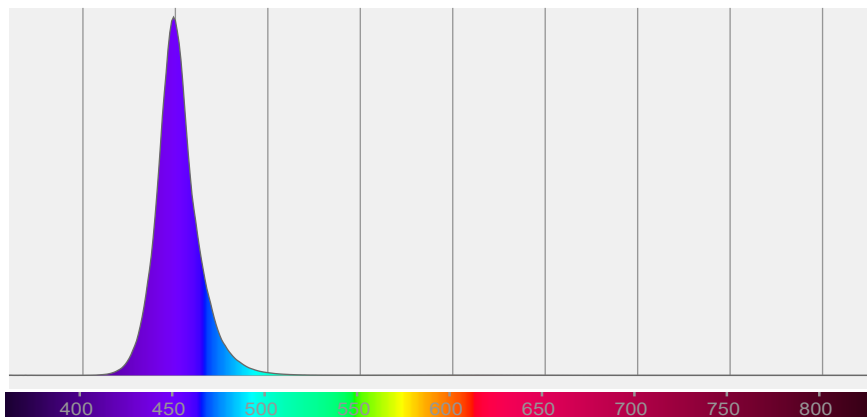

BEAM DETAILS



Beam angle 50%	Field angle 10%	Cut off angle 2,5%	Intensity ratio in 120° cone	Intensity ratio in 90° cone
15,4°	26,9°	36,1°	98,4%	95,6%

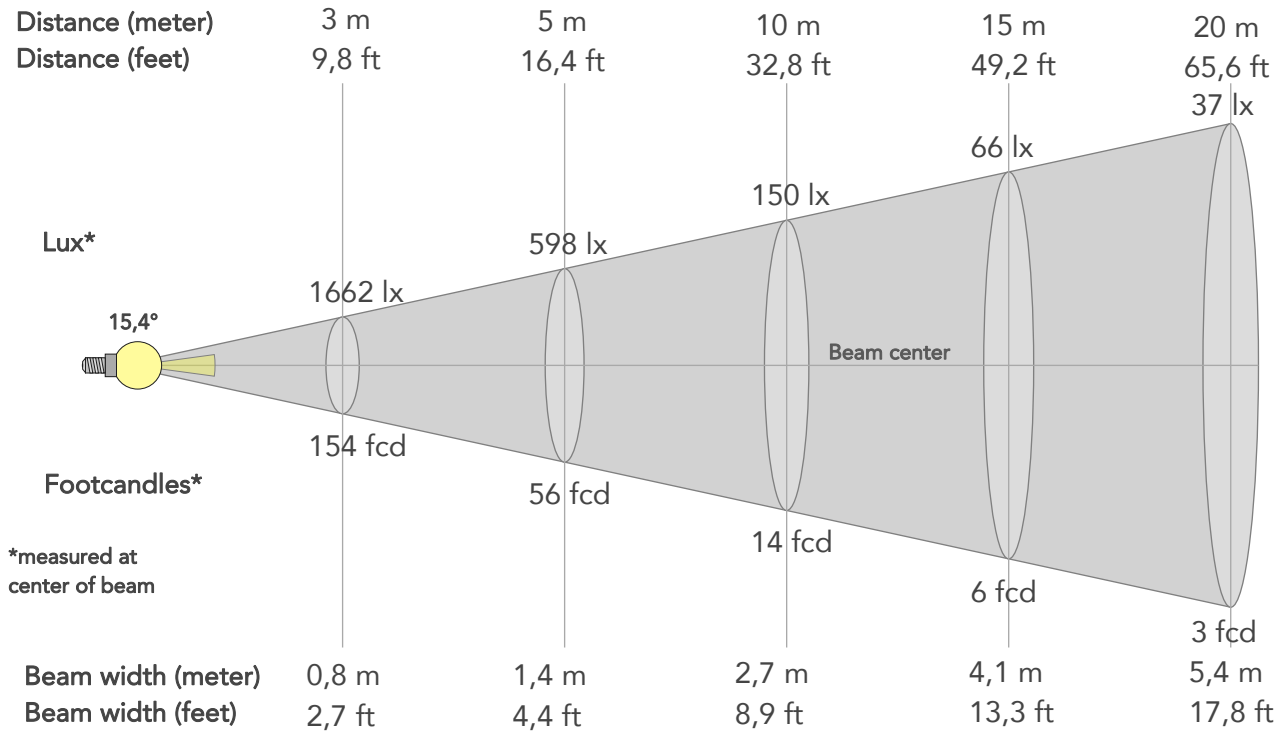

BEAM INTENSITIES AND WIDTHS

Distance	1m	2m	3m	4m	5m	7,5m	10m	15m	20m	25m	30m	40m	50m
Distance	3,3ft	6,6ft	9,8ft	13,1ft	16,4ft	24,6ft	32,8ft	49,2ft	65,6ft	82ft	98,4ft	131,2ft	164ft
Lux	14954lx	3738lx	1662lx	935lx	598lx	266lx	150lx	66lx	37lx	24lx	17lx	9lx	6lx
Footcand.	1389fcd	347fcd	154fcd	87fcd	56fcd	25fcd	14fcd	6fcd	3fcd	2fcd	2fcd	1fcd	1fcd
Beam wid.	0,3m	0,5m	0,8m	1,1m	1,4m	2m	2,7m	4,1m	5,4m	6,8m	8,1m	10,8m	13,5m
Beam wid.	0,9ft	1,8ft	2,7ft	3,5ft	4,4ft	6,7ft	8,9ft	13,3ft	17,8ft	22,2ft	26,7ft	35,5ft	44,4ft

LINEAR DISTRIBUTION DIAGRAM

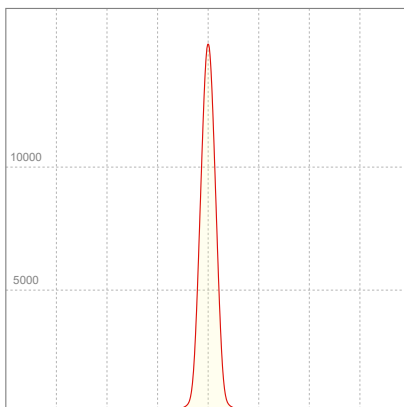

ELECTRICAL SPECIFICATIONS

Input voltage	Input current	Input power	Power FC	Efficiency
226V	0,566A	105,4W	0,82	13lm/W

ISO DIAGRAMS

ISO CANDELA DIAGRAM

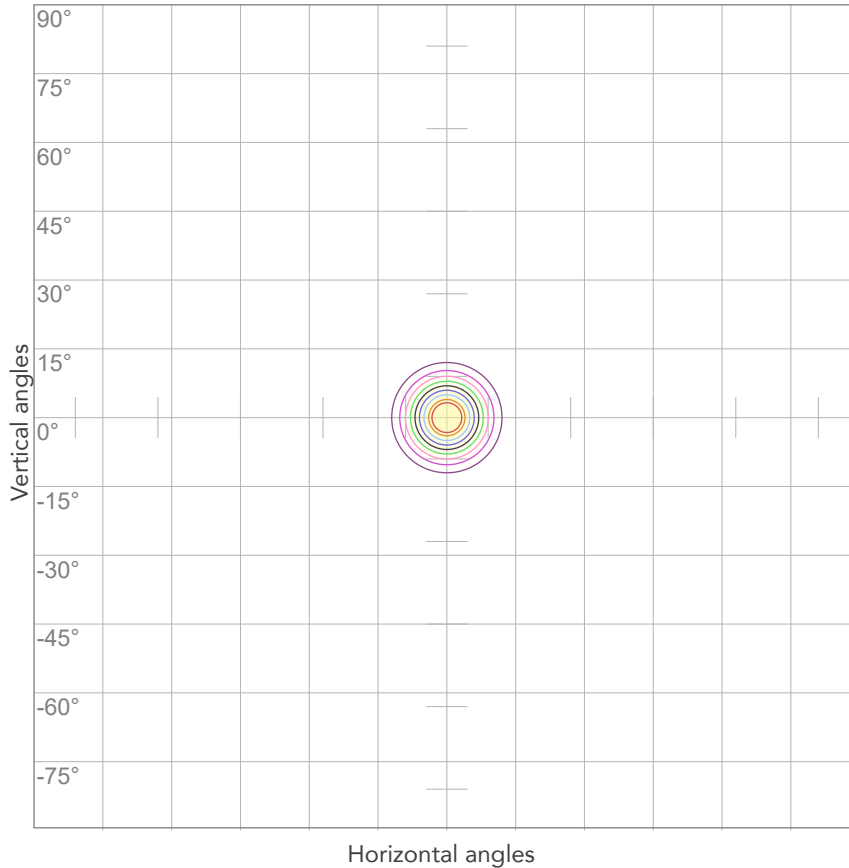

10%	1495 cd
20%	2991 cd
30%	4486 cd
40%	5981 cd
50%	7477 cd
60%	8972 cd
70%	10468 cd
80%	11963 cd

Conditions:

Number of c-planes: 2

Candela at center: 14954 cd

ISO LUX DIAGRAM

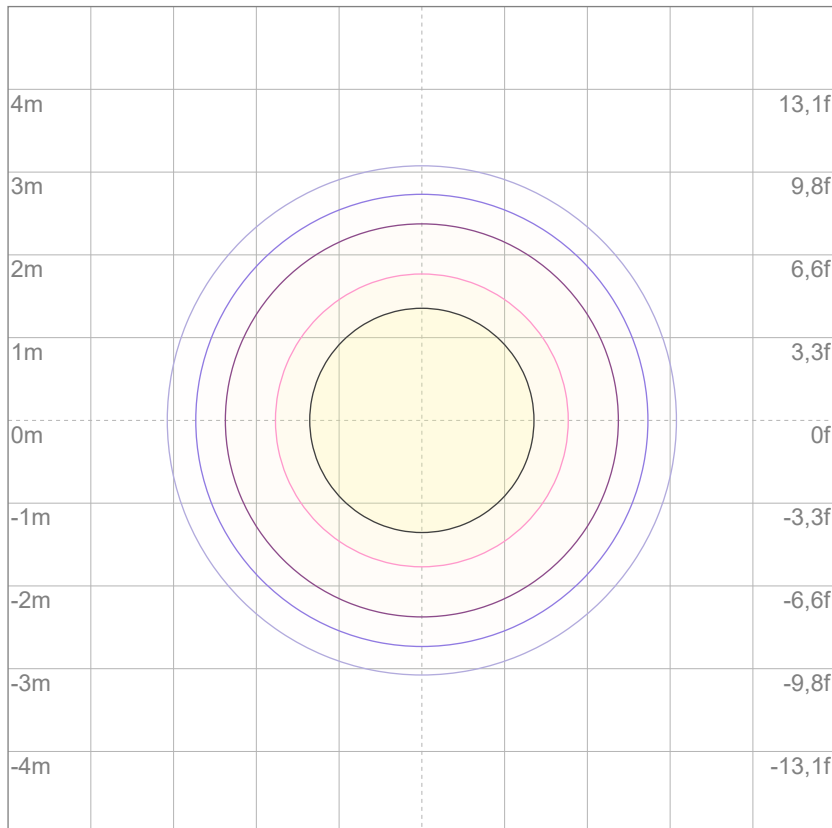

3%	4,49 lx
5%	7,48 lx
10%	15,0 lx
30%	44,9 lx
50%	74,8 lx

Conditions:

Number of c-planes: 2

Lux at center: 150 lx

Lux distribution on a surface when lamp is mounted at 10 meters from the surface.

Mounting height: 10 meters (33 feet)



Total lumen output:

9950 lm

Peak candela output:

105295 cd

Light quality:

CRI: 83,9

Color temperature:

2975 K

PRODUCT NAME:

ARCSPOTXLFC

MEASURAMENT CONDITIONS:

Beam angle:

15Deg Optic

Target:

White

Operator:

Salvatore Giglio

Date and time:

04/11/2024 17:46:42

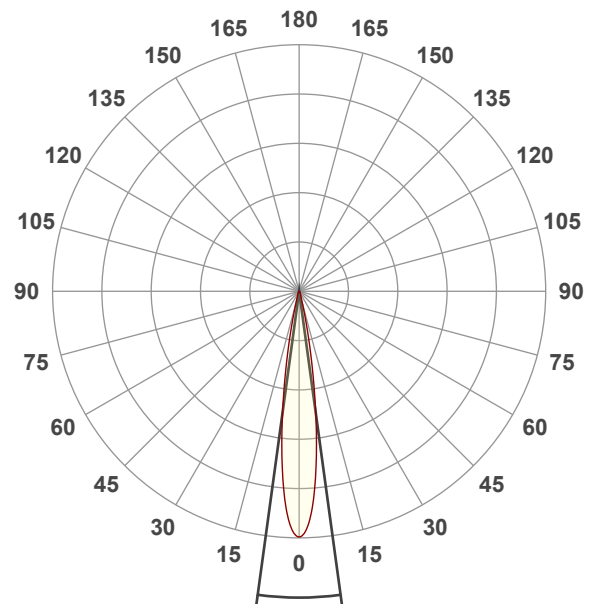

Beam angle 50%: 15,6°

Field angle 10%: 26,6°

Cut off angle 2.5%: 36,8°

Spectra

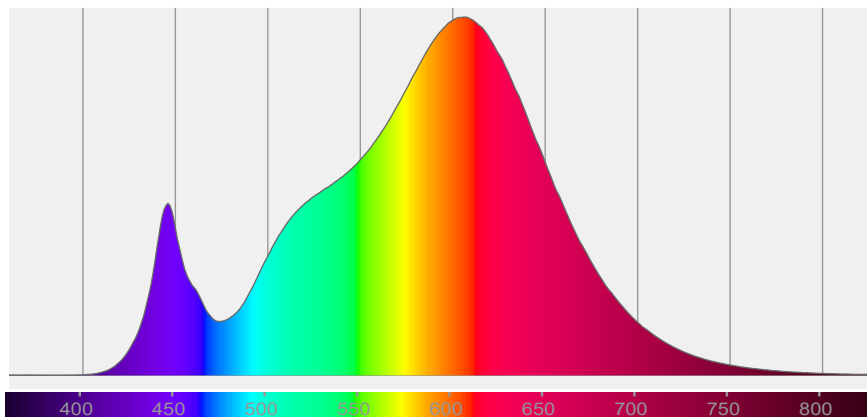

COLOR DETAILS

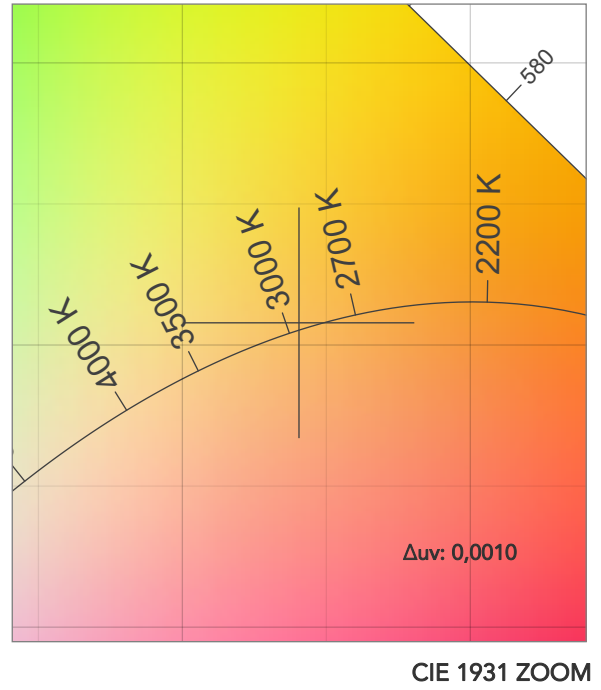
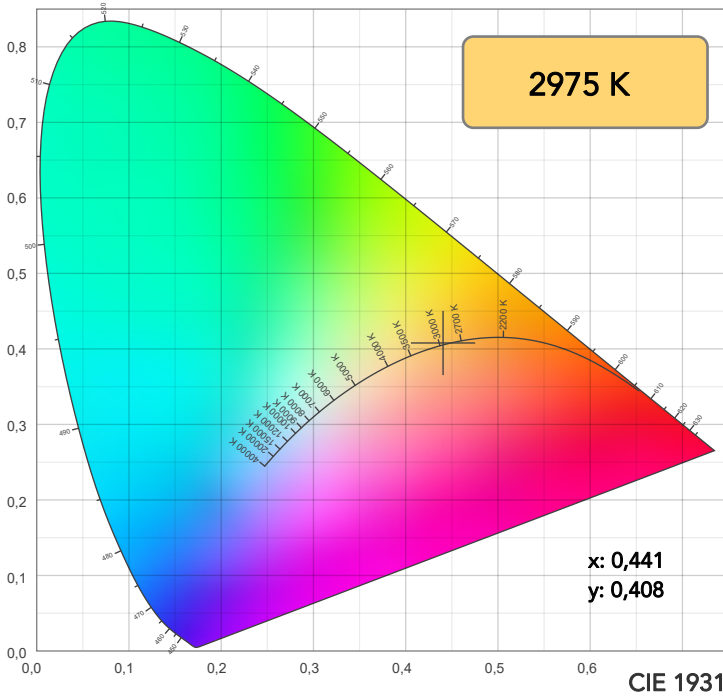

TM30: 85,7

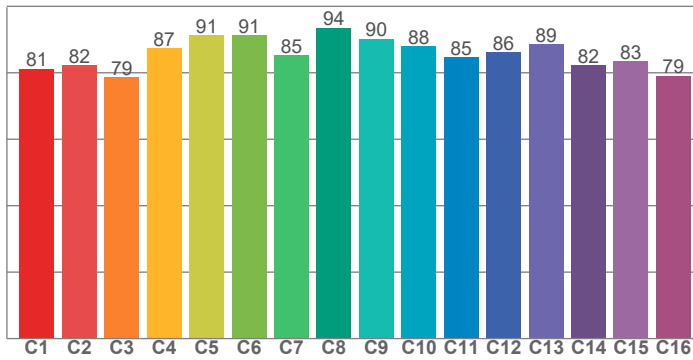

CRI: 83,9 (R1-R8)

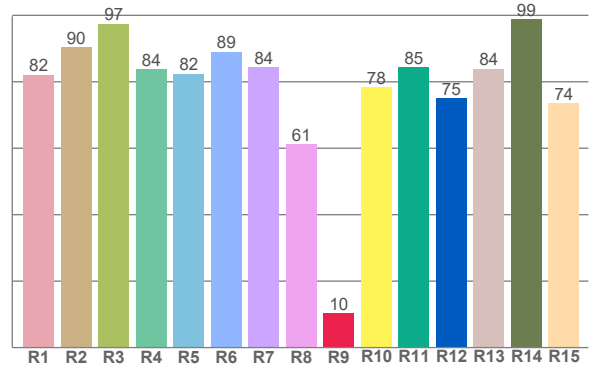

CQS: 83,2

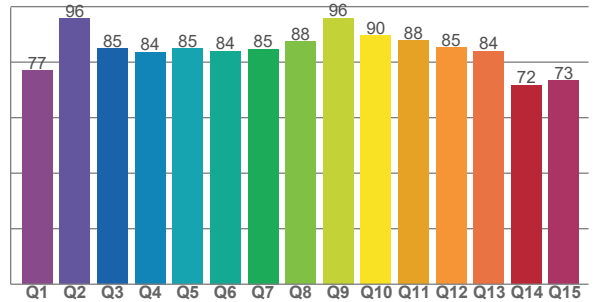

CRI R values, only R1-R8 are used to calculate final CRI value

R1	R2	R3	R4	R5	R6	R7	R8	R9	R10	R11	R12	R13	R14	R15
82,1	90,3	97,5	83,8	82,4	89,0	84,3	61,3	10,4	78,4	84,5	75,1	83,9	98,8	73,5

TM30 C values, 16 binned values out of total of 99 C values

C1	C2	C3	C4	C5	C6	C7	C8	C9	C10	C11	C12	C13	C14	C15	C16
81,2	82,3	78,7	87,4	91,2	91,4	85,3	93,6	90,3	88,0	84,6	86,2	88,6	82,2	83,4	79,1

CQS Q values

Q1	Q2	Q3	Q4	Q5	Q6	Q7	Q8	Q9	Q10	Q11	Q12	Q13	Q14	Q15
76,9	95,7	84,9	83,7	85,0	84,1	84,7	87,5	95,8	89,7	87,7	85,3	83,9	71,7	73,4

COLOR PARAMETERS

Color temperature	Color rendering index	Red component	Color fidelity	Color gamut	Color quality scale	Television lighting index	Color coordinate cie 1931	Color coordinate cie 1931	Color deviation from black body
CCT	CRI	CRI R9	TM30 Rf	TM30 Rg	CQS	TLCI	x	y	Δuv
2975 K	83,9	10,4	85,7	97,5	83,2	68	0,441	0,408	0,0010

TM30 DETAILS

Rf 85,7
Fidelity index Rf

Rg 97,5
Gammut index

Hue Bin	R _f	Graphic shifts (%)	
		Chroma	Hue
1	81	-11%	-2%
2	82	-8%	7%
3	79	-3%	11%
4	87	3%	8%
5	91	5%	5%
6	91	5%	-2%
7	85	0%	-9%
8	94	-2%	-3%
9	90	-6%	-1%
10	88	-6%	5%
11	85	-2%	10%
12	86	5%	3%
13	89	5%	-6%
14	82	5%	-14%
15	83	-1%	-10%
16	79	-8%	-15%

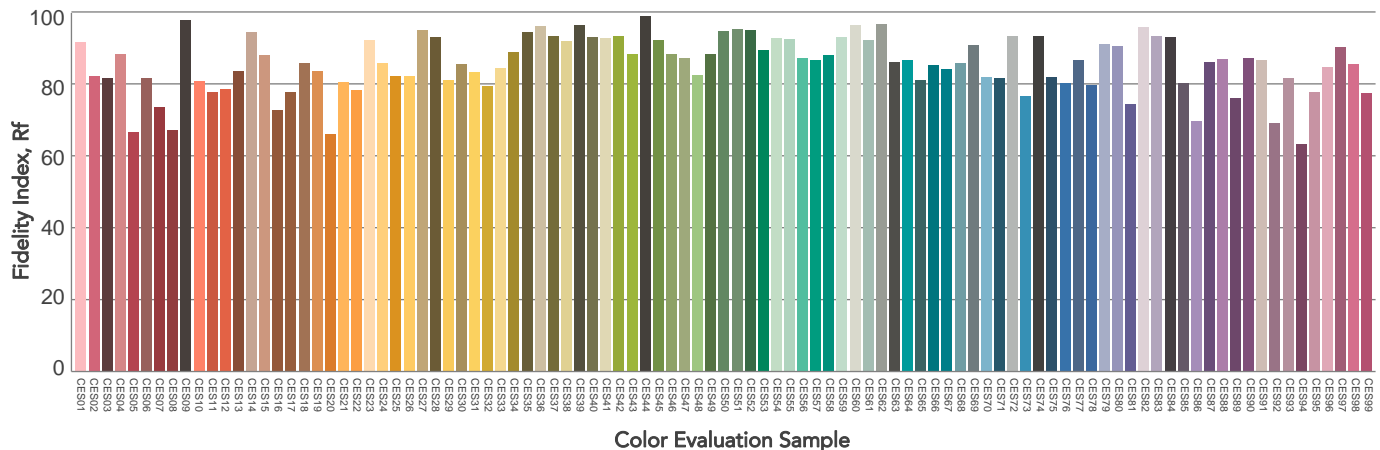
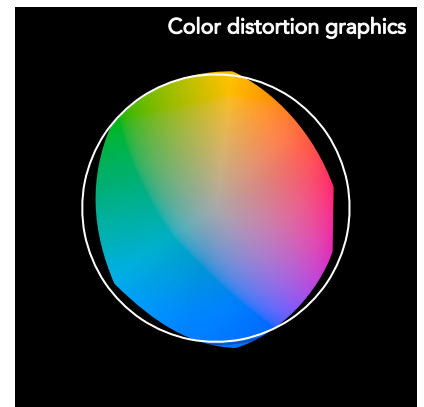
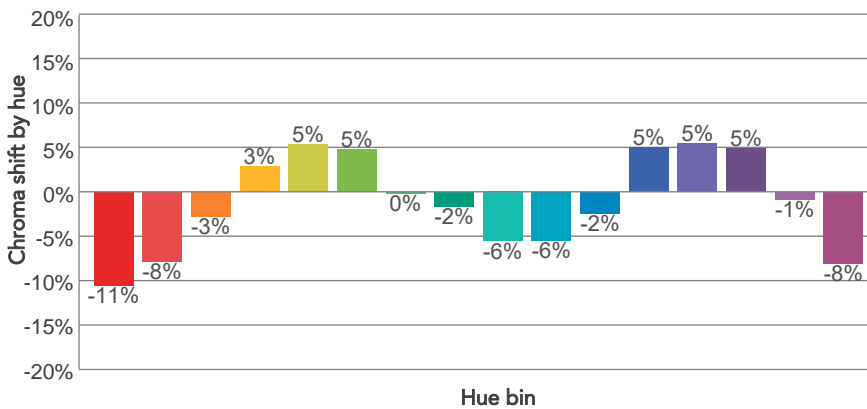
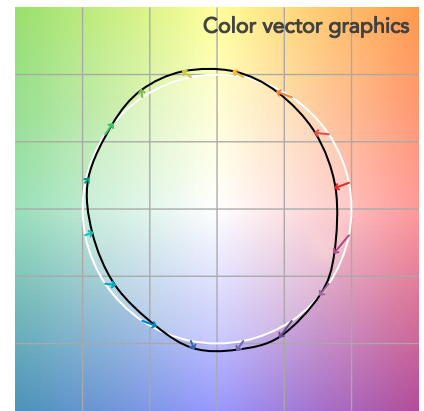
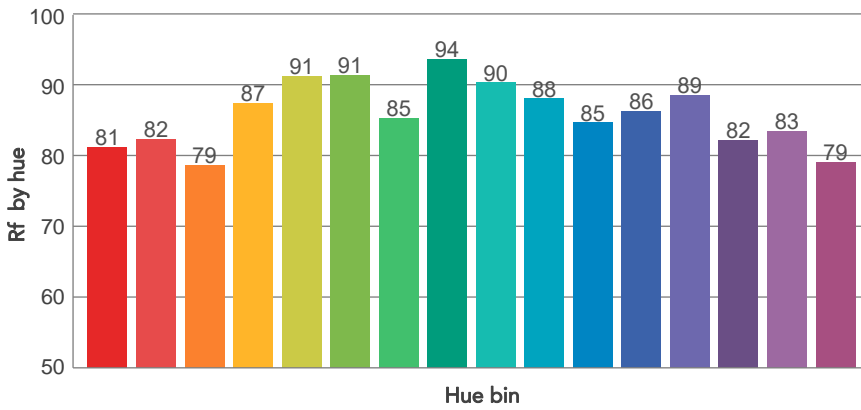
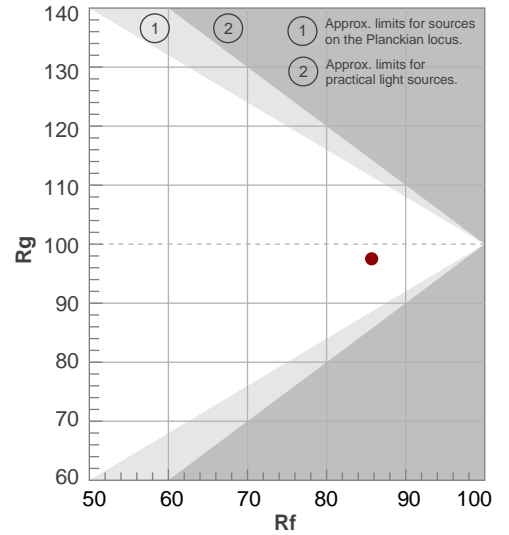

BEAM DETAILS



Beam angle 50%	Field angle 10%	Cut off angle 2,5%	Intensity ratio in 120° cone	Intensity ratio in 90° cone
15,6°	26,6°	36,8°	98,3%	95,2%

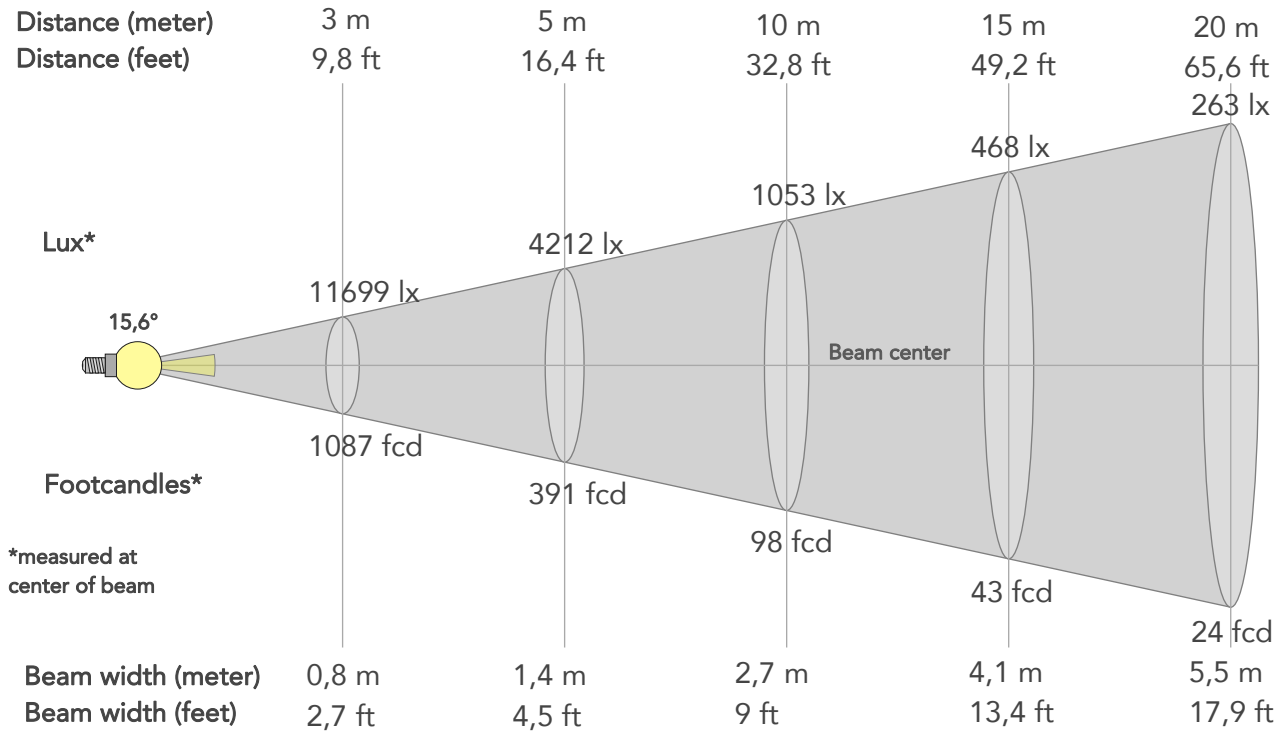

BEAM INTENSITIES AND WIDTHS

Distance	1m	2m	3m	4m	5m	7,5m	10m	15m	20m	25m	30m	40m	50m
Distance	3,3ft	6,6ft	9,8ft	13,1ft	16,4ft	24,6ft	32,8ft	49,2ft	65,6ft	82ft	98,4ft	131,2ft	164ft
Lux	105295lx	26324lx	11699lx	6581lx	4212lx	1872lx	1053lx	468lx	263lx	168lx	117lx	66lx	42lx
Footcand.	9782fcd	2446fcd	1087fcd	611fcd	391fcd	174fcd	98fcd	43fcd	24fcd	16fcd	11fcd	6fcd	4fcd
Beam wid.	0,3m	0,5m	0,8m	1,1m	1,4m	2m	2,7m	4,1m	5,5m	6,8m	8,2m	10,9m	13,7m
Beam wid.	0,9ft	1,8ft	2,7ft	3,6ft	4,5ft	6,7ft	9ft	13,4ft	17,9ft	22,4ft	26,9ft	35,8ft	44,8ft

LINEAR DISTRIBUTION DIAGRAM

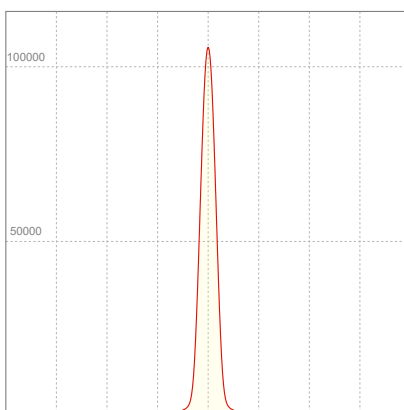

ELECTRICAL SPECIFICATIONS

Input voltage	Input current	Input power	Power FC	Efficiency
227V	0,681A	136,2W	0,88	73lm/W

ISO DIAGRAMS

ISO CANDELA DIAGRAM

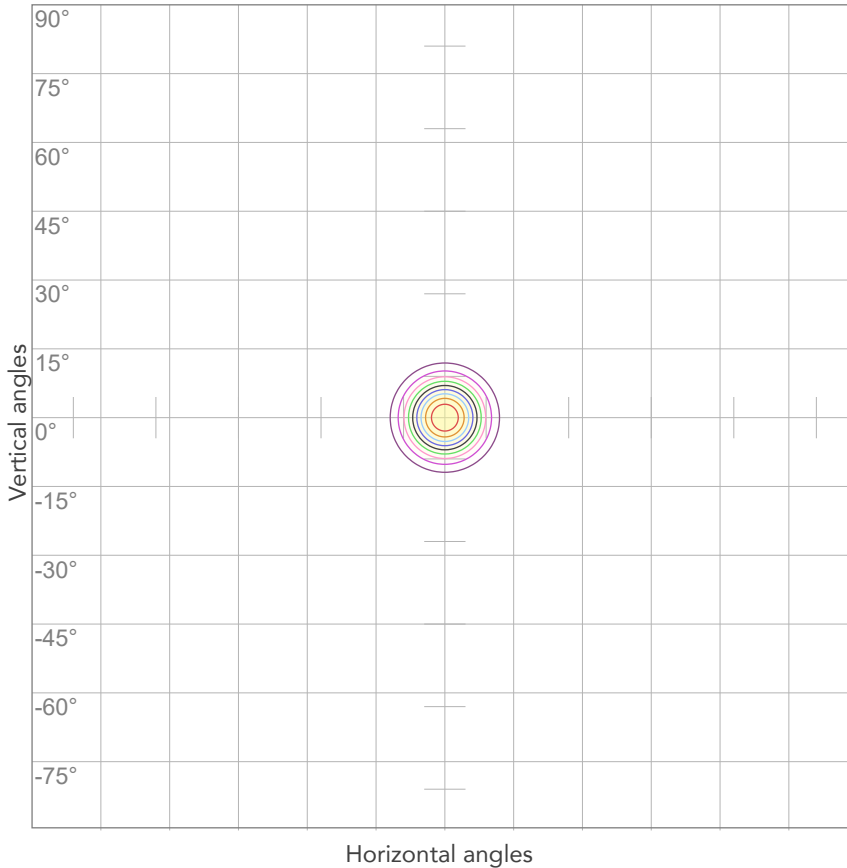

10%	10530 cd
20%	21059 cd
30%	31589 cd
40%	42118 cd
50%	52648 cd
60%	63177 cd
70%	73707 cd
80%	84236 cd

Conditions:

Number of c-planes: 2

Candela at center: 105295 cd

ISO LUX DIAGRAM

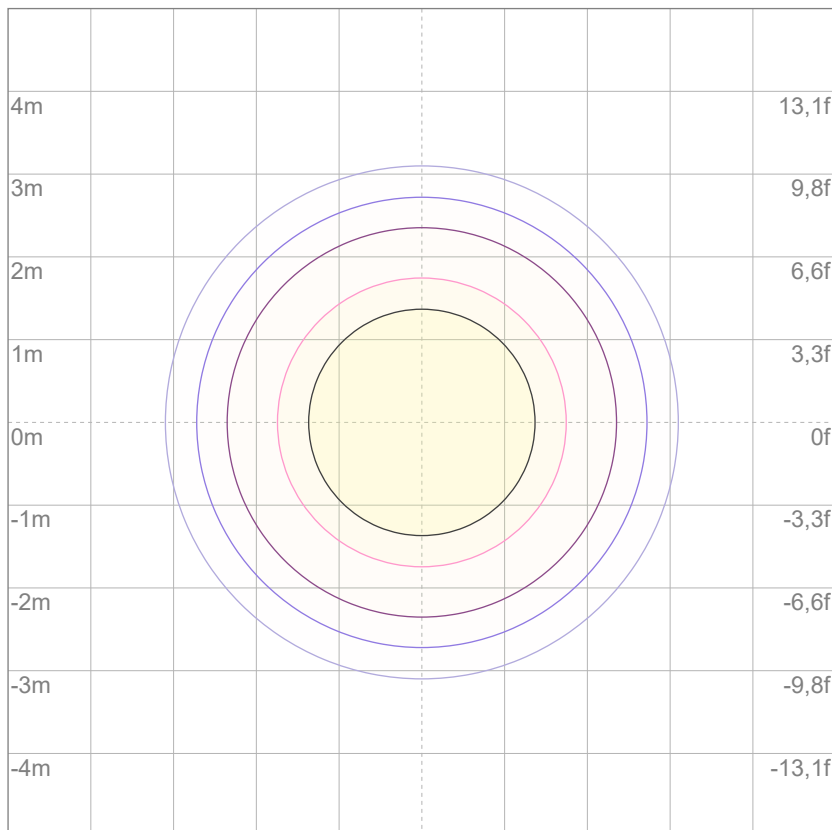

3%	31,6 lx
5%	52,6 lx
10%	105 lx
30%	316 lx
50%	526 lx

Conditions:

Number of c-planes: 2

Lux at center: 1053 lx

Lux distribution on a surface when lamp is mounted at 10 meters from the surface.

Mounting height: 10 meters (33 feet)



Total lumen output:

13358 lm

Peak candela output:

145625 cd

Light quality:

CRI: 84,7

Color temperature:

2830 K

PRODUCT NAME:

ARCSPOTXLFC

MEASURAMENT CONDITIONS:

Beam angle:

15Deg Optic

Target:

2800K

Operator:

Salvatore Giglio

Date and time:

04/11/2024 18:03:17

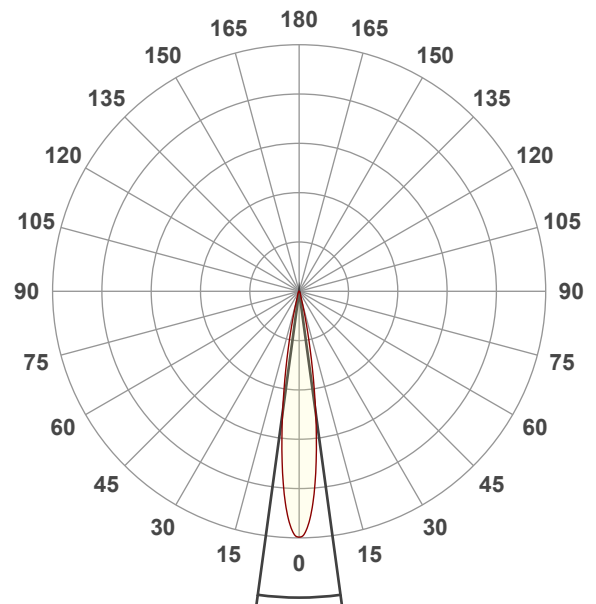

Beam angle 50%: 15,5°

Field angle 10%: 26,6°

Cut off angle 2.5%: 36,3°

Spectra

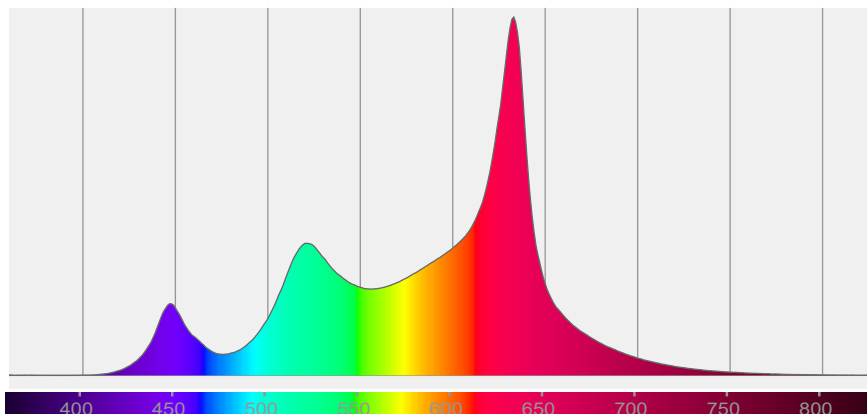

COLOR DETAILS

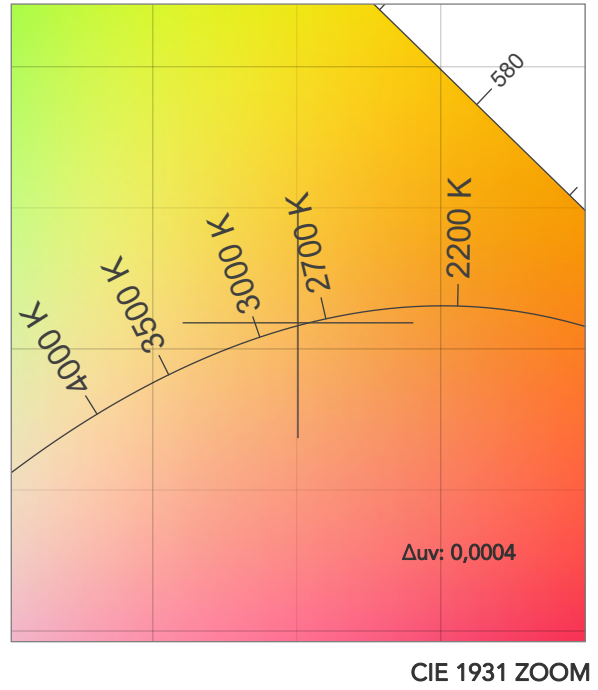
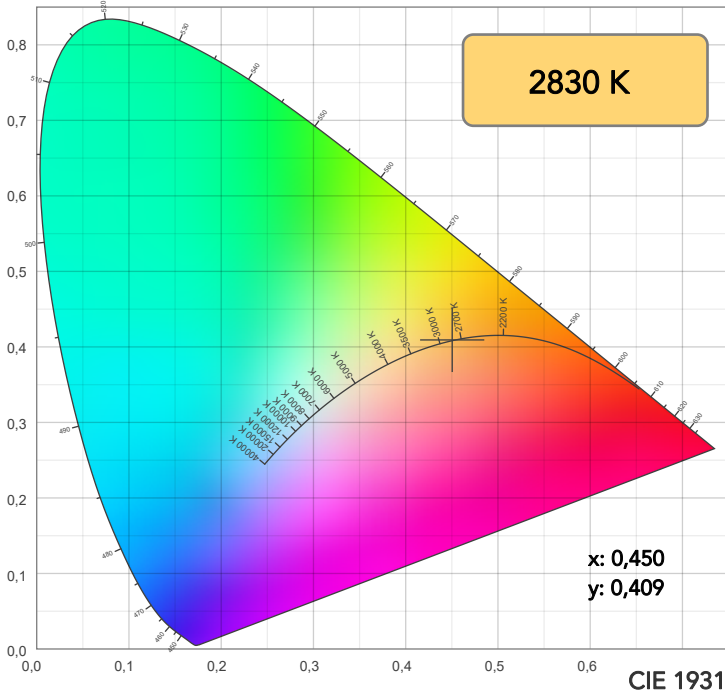

TM30: 88,3

CRI: 84,7 (R1-R8)

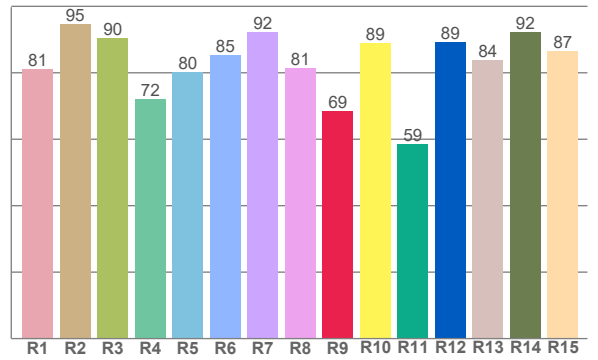
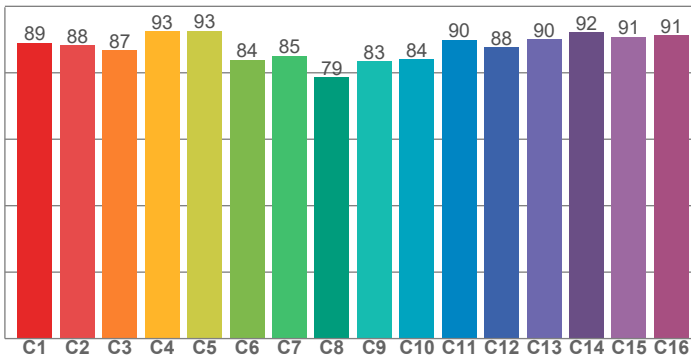

CRI R values, only R1-R8 are used to calculate final CRI value

R1	R2	R3	R4	R5	R6	R7	R8	R9	R10	R11	R12	R13	R14	R15
81,0	94,7	90,5	72,0	80,3	85,3	92,2	81,4	68,5	88,9	58,6	89,2	83,7	92,3	86,6

TM30 C values, 16 binned values out of total of 99 C values

C1	C2	C3	C4	C5	C6	C7	C8	C9	C10	C11	C12	C13	C14	C15	C16
89,0	88,3	86,7	92,5	92,6	83,9	85,1	78,7	83,5	84,0	89,9	87,7	90,1	92,2	90,8	91,2

CQS Q values

Q1	Q2	Q3	Q4	Q5	Q6	Q7	Q8	Q9	Q10	Q11	Q12	Q13	Q14	Q15
96,6	94,8	93,5	80,6	77,1	78,0	93,8	90,0	93,7	93,3	83,5	82,4	84,9	93,1	94,7

CQS: 86,6

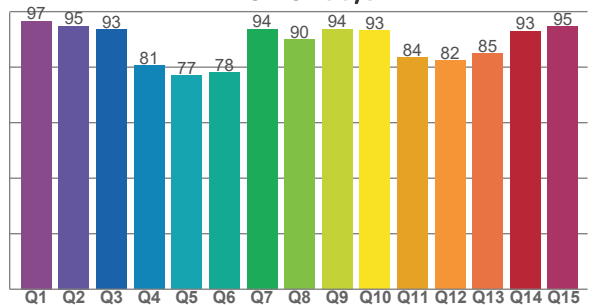

COLOR PARAMETERS

Color temperature	Color rendering index	Red component	Color fidelity	Color gamut	Color quality scale	Television lighting index	Color coordinate cie 1931	Color coordinate cie 1931	Color deviation from black body
CCT	CRI	CRI R9	TM30 Rf	TM30 Rg	CQS	TLCI	x	y	Δuv
2830 K	84,7	68,5	88,3	108,4	86,6	68	0,450	0,409	0,0004

TM30 DETAILS

Rf 88,3
Fidelity index Rf

Rg 108,4
Gammut index

Hue Bin	R _f	Graphic shifts (%)	
		Chroma	Hue
1	89	4%	-2%
2	88	4%	-4%
3	87	3%	-5%
4	93	1%	-3%
5	93	3%	4%
6	84	8%	7%
7	85	10%	1%
8	79	13%	-4%
9	83	7%	-7%
10	84	3%	-10%
11	90	0%	-7%
12	88	2%	-7%
13	90	2%	-7%
14	92	1%	-2%
15	91	4%	1%
16	91	5%	-4%

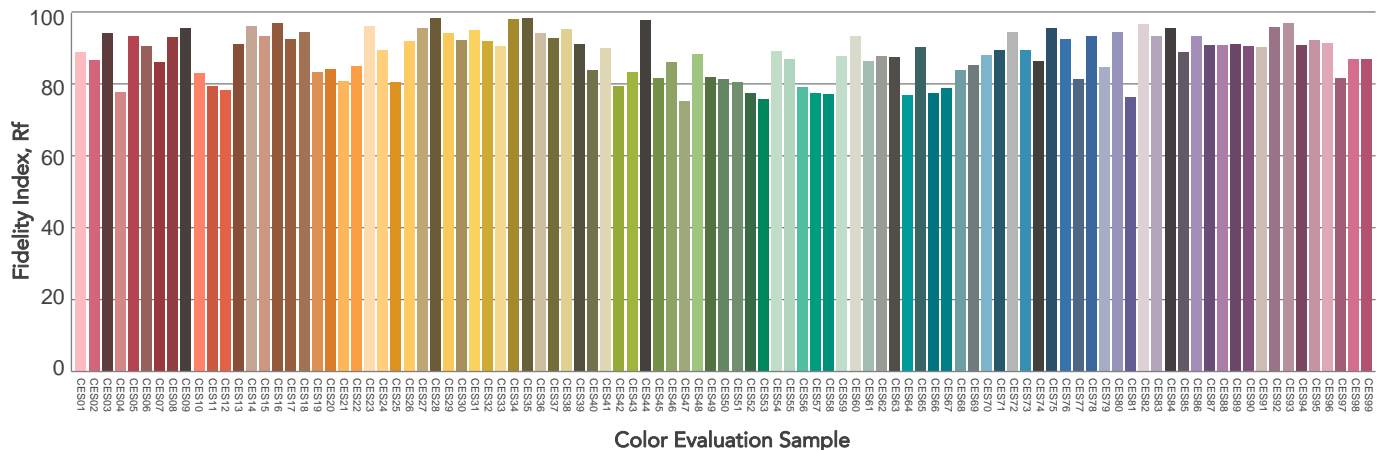
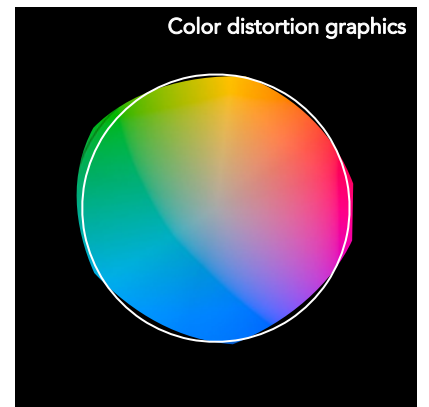
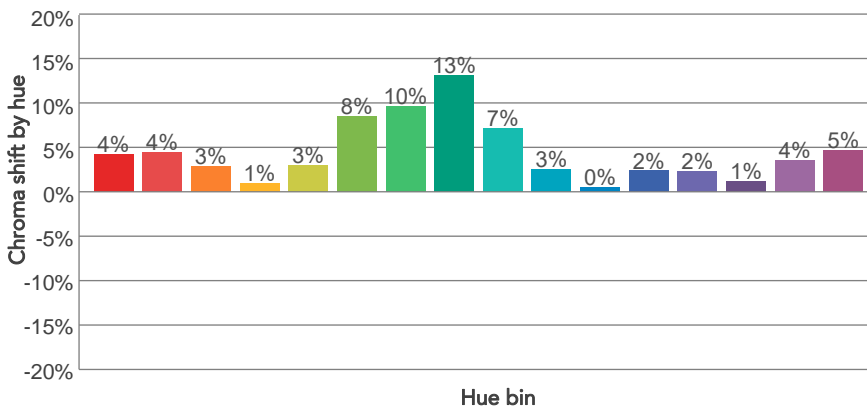
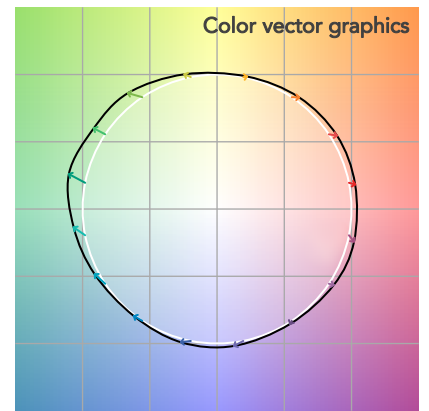
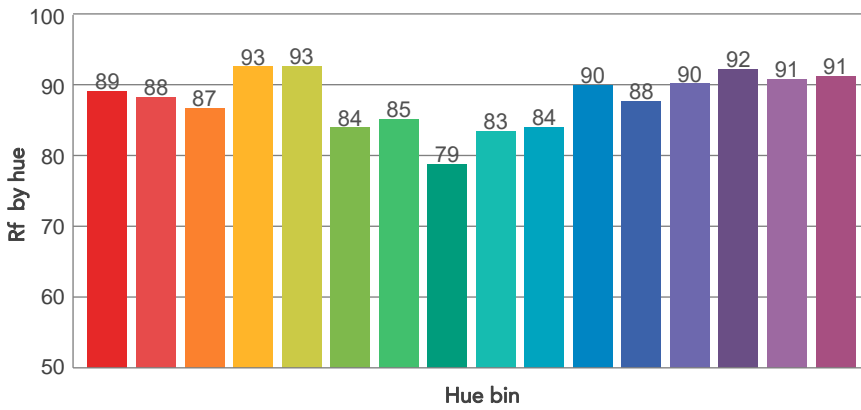
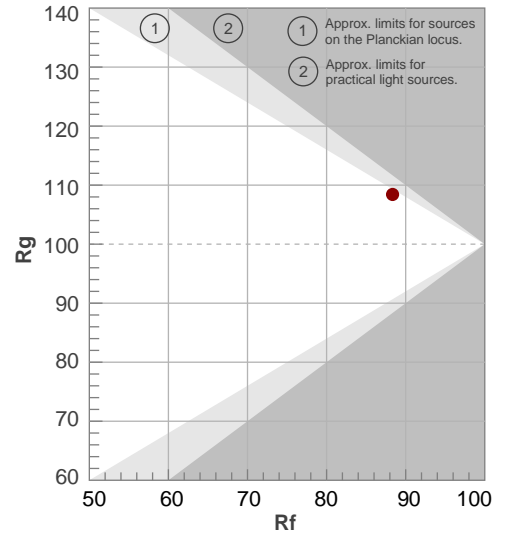

BEAM DETAILS



Beam angle 50%	Field angle 10%	Cut off angle 2,5%	Intensity ratio in 120° cone	Intensity ratio in 90° cone
15,5°	26,6°	36,3°	99,2%	96,8%

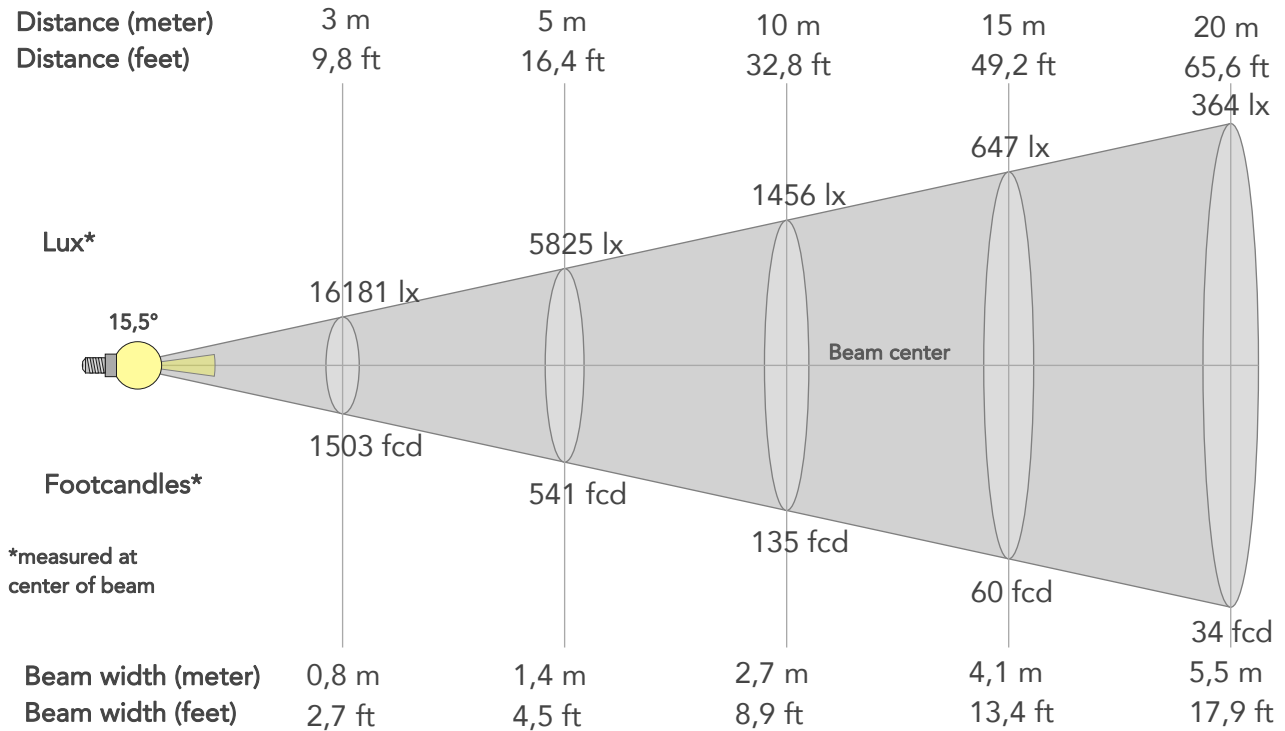

BEAM INTENSITIES AND WIDTHS

Distance	1m	2m	3m	4m	5m	7,5m	10m	15m	20m	25m	30m	40m	50m
Distance	3,3ft	6,6ft	9,8ft	13,1ft	16,4ft	24,6ft	32,8ft	49,2ft	65,6ft	82ft	98,4ft	131,2ft	164ft
Lux	145625lx	36406lx	16181lx	9102lx	5825lx	2589lx	1456lx	647lx	364lx	233lx	162lx	91lx	58lx
Footcand.	13529fcd	3382fcd	1503fcd	846fcd	541fcd	241fcd	135fcd	60fcd	34fcd	22fcd	15fcd	8fcd	5fcd
Beam wid.	0,3m	0,5m	0,8m	1,1m	1,4m	2m	2,7m	4,1m	5,5m	6,8m	8,2m	10,9m	13,6m
Beam wid.	0,9ft	1,8ft	2,7ft	3,6ft	4,5ft	6,7ft	8,9ft	13,4ft	17,9ft	22,4ft	26,8ft	35,8ft	44,7ft

LINEAR DISTRIBUTION DIAGRAM

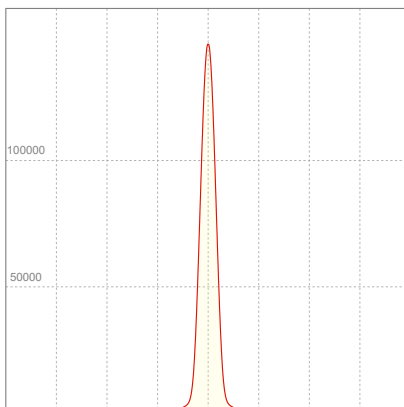

ELECTRICAL SPECIFICATIONS

Input voltage	Input current	Input power	Power FC	Efficiency
226V	0,984A	209,9W	0,95	64lm/W

ISO DIAGRAMS

ISO CANDELA DIAGRAM

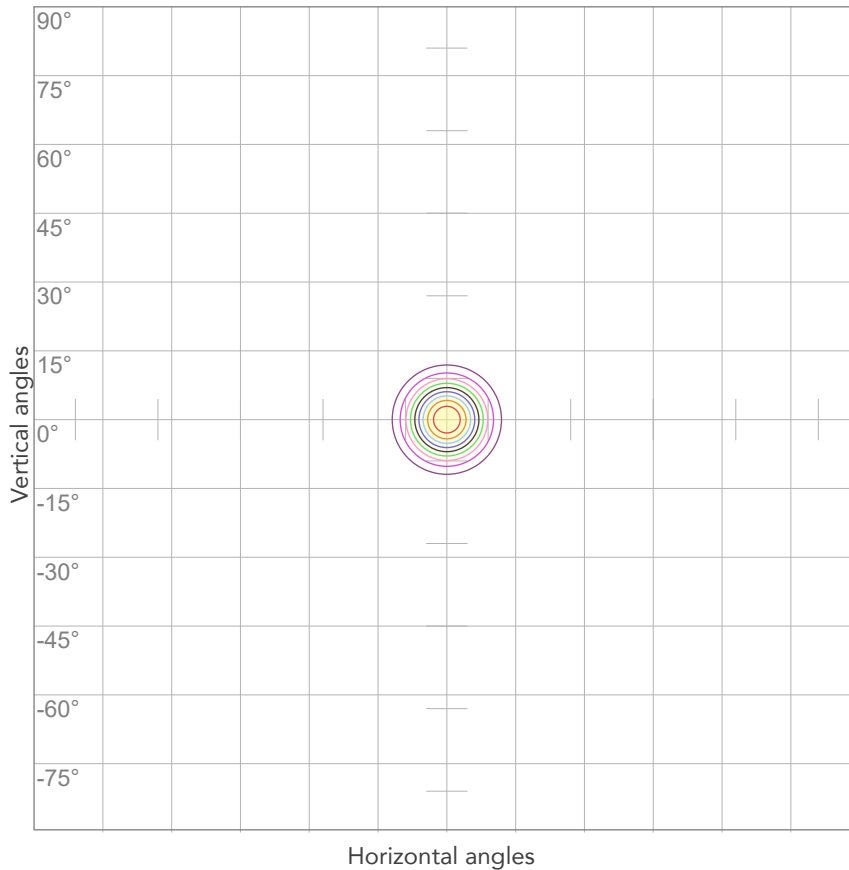

10%	14563 cd
20%	29125 cd
30%	43688 cd
40%	58250 cd
50%	72813 cd
60%	87375 cd
70%	101938 cd
80%	116500 cd

Conditions:

Number of c-planes: 2

Candela at center: 145625 cd

ISO LUX DIAGRAM

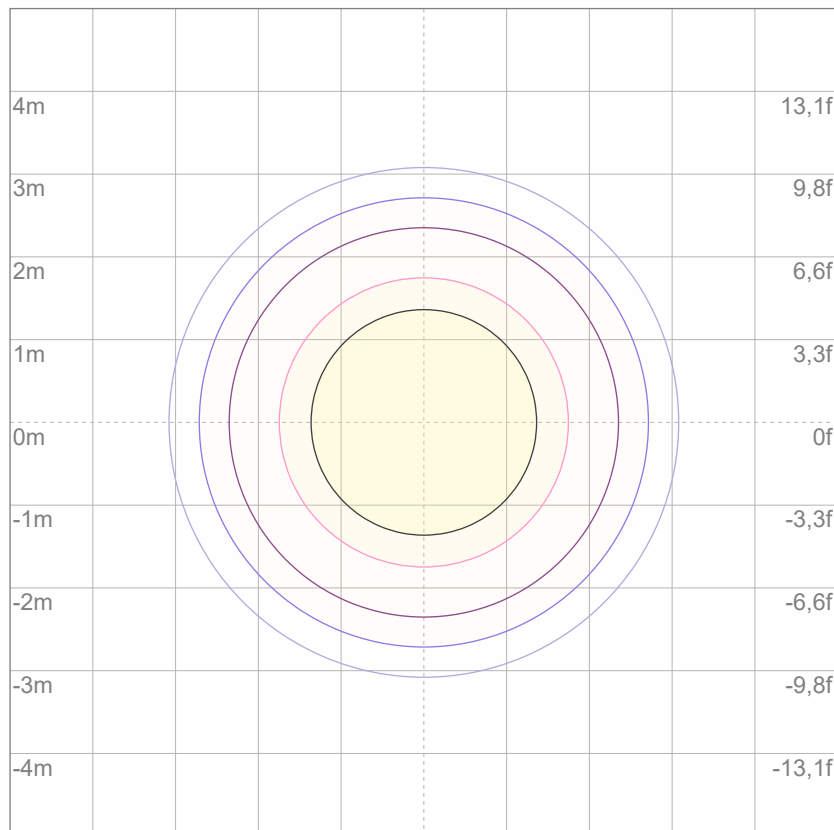

3%	43,7 lx
5%	72,8 lx
10%	146 lx
30%	437 lx
50%	728 lx

Conditions:

Number of c-planes: 2

Lux at center: 1456 lx

Lux distribution on a surface when lamp is mounted at 10 meters from the surface.

Mounting height: 10 meters (33 feet)



Total lumen output:

14069 lm

Peak candela output:

152371 cd

Light quality:

CRI: 83,7

Color temperature:

3261 K

PRODUCT NAME:

ARCSPOTXLFC

MEASUREMENT CONDITIONS:

Beam angle:

15Deg Optic

Target:

3200K

Operator:

Salvatore Giglio

Date and time:

04/11/2024 17:49:42

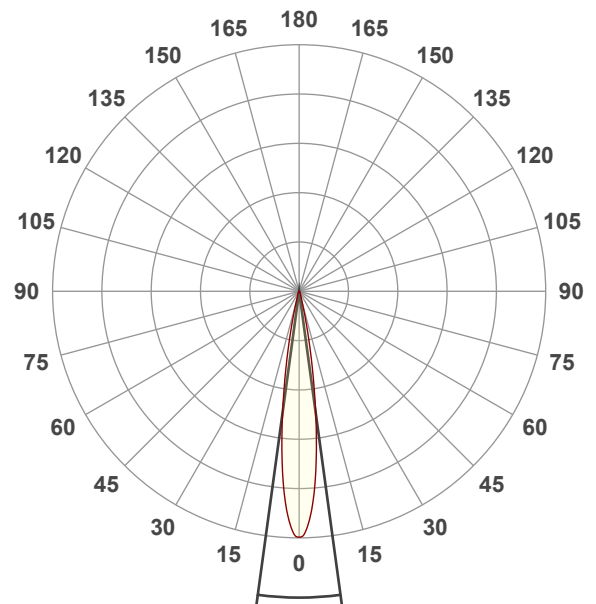

Beam angle 50%: 15,5°

Field angle 10%: 26,7°

Cut off angle 2.5%: 36,5°

Spectra

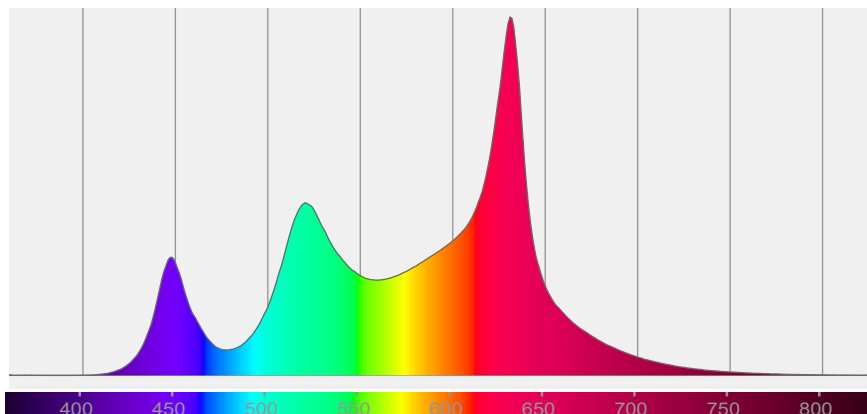

COLOR DETAILS

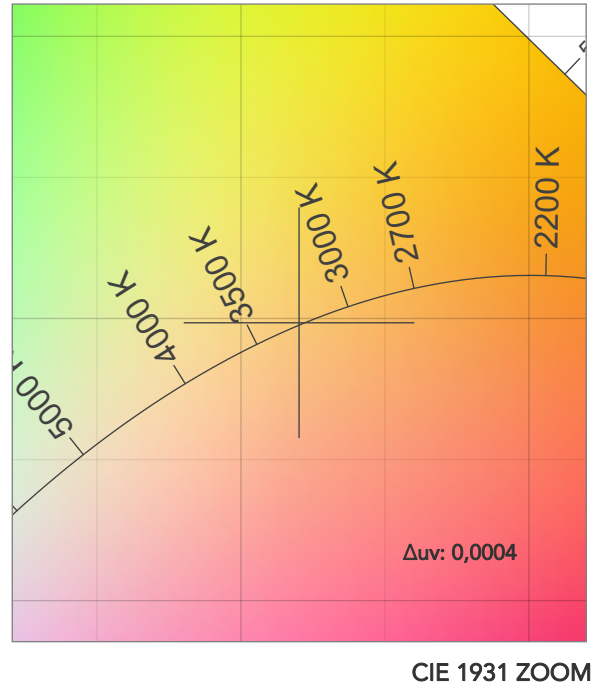
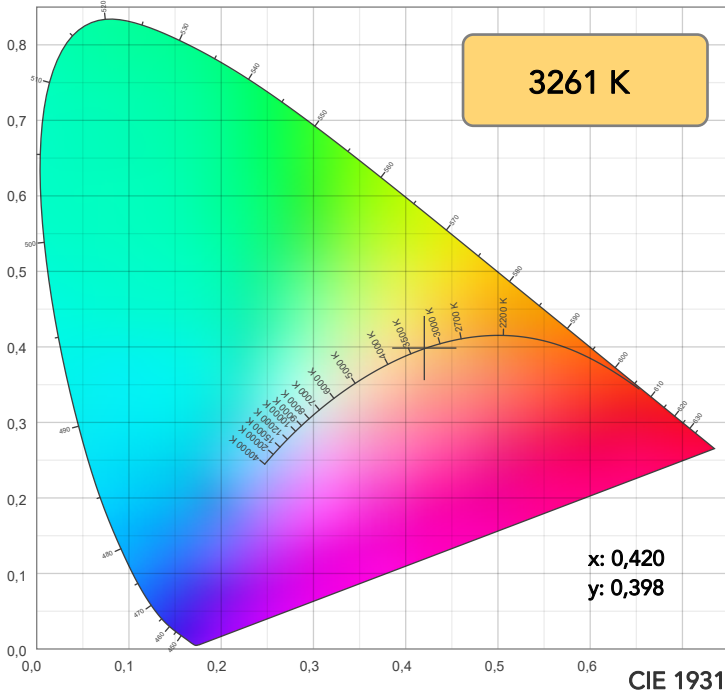

TM30: 88,1

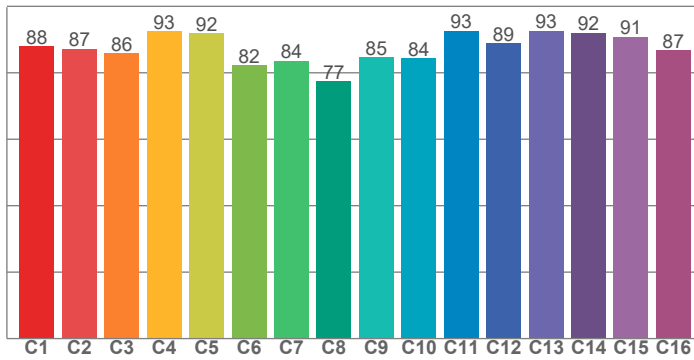

CRI: 83,7 (R1-R8)

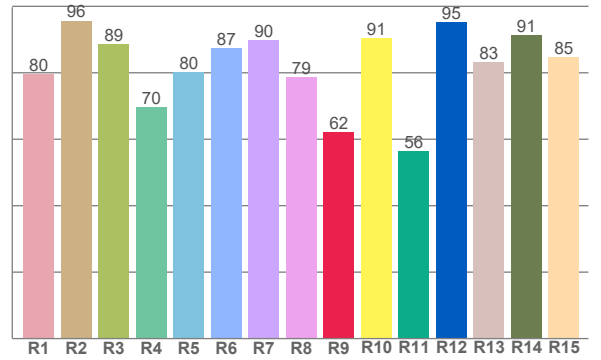

CRI R values, only R1-R8 are used to calculate final CRI value

R1	R2	R3	R4	R5	R6	R7	R8	R9	R10	R11	R12	R13	R14	R15
79,6	95,7	88,5	69,6	80,1	87,4	89,7	78,6	62,2	90,5	56,3	95,1	83,2	91,3	84,6

TM30 C values, 16 binned values out of total of 99 C values

C1	C2	C3	C4	C5	C6	C7	C8	C9	C10	C11	C12	C13	C14	C15	C16
87,9	87,2	85,8	92,5	91,9	82,2	83,6	77,5	84,7	84,4	92,6	88,9	92,6	92,1	90,9	86,7

CQS Q values

Q1	Q2	Q3	Q4	Q5	Q6	Q7	Q8	Q9	Q10	Q11	Q12	Q13	Q14	Q15
97,2	97,2	96,7	82,1	77,2	78,1	94,2	89,9	93,7	95,5	83,4	81,7	84,3	93,4	94,9

CQS: 87,0

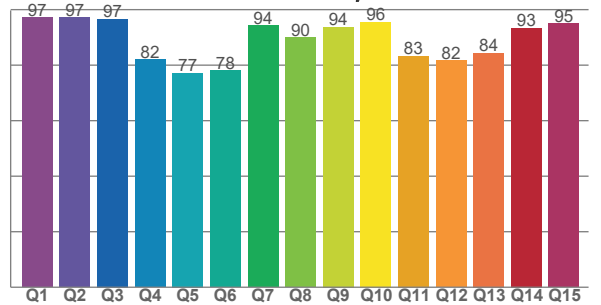

COLOR PARAMETERS

Color temperature	Color rendering index	Red component	Color fidelity	Color gamut	Color quality scale	Television lighting index	Color coordinate cie 1931	Color coordinate cie 1931	Color deviation from black body
CCT	CRI	CRI R9	TM30 Rf	TM30 Rg	CQS	TLCI	x	y	Δuv
3261 K	83,7	62,2	88,1	109,9	87,0	65	0,420	0,398	0,0004

TM30 DETAILS

Rf 88,1
Fidelity index Rf

Rg 109,9
Gammut index

Hue Bin	R _f	Graphic shifts (%)	
		Chroma	Hue
1	88	5%	-2%
2	87	5%	-4%
3	86	3%	-5%
4	93	1%	-2%
5	92	3%	4%
6	82	9%	7%
7	84	10%	1%
8	77	13%	-5%
9	85	8%	-7%
10	84	2%	-9%
11	93	0%	-4%
12	89	4%	-5%
13	93	3%	-4%
14	92	3%	0%
15	91	5%	2%
16	87	8%	-5%

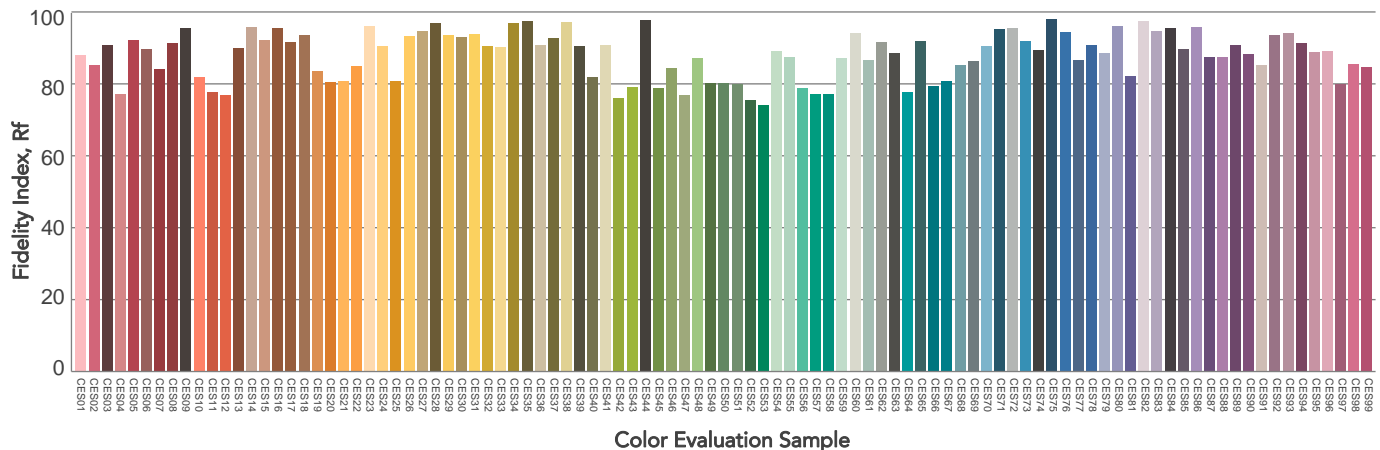
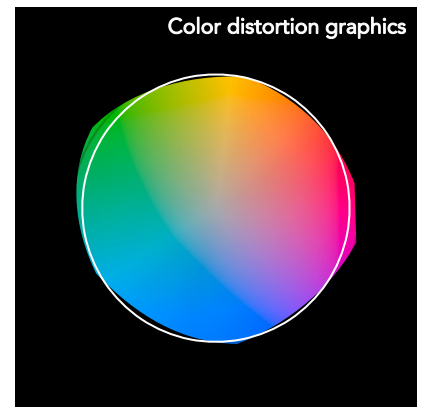
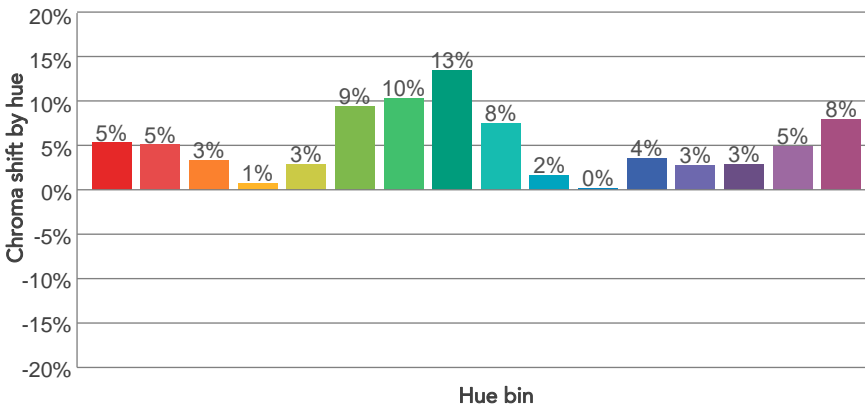
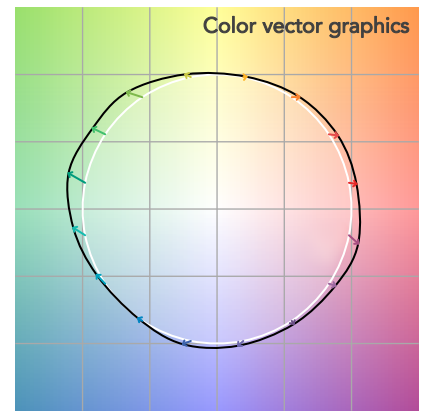
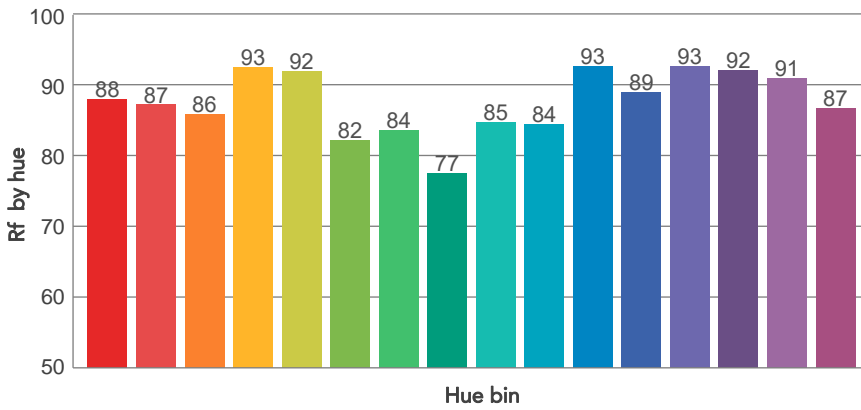
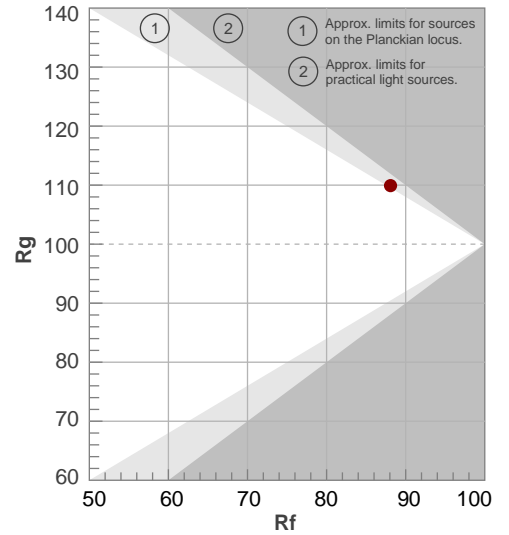

BEAM DETAILS



Beam angle 50%	Field angle 10%	Cut off angle 2,5%	Intensity ratio in 120° cone	Intensity ratio in 90° cone
15,5°	26,7°	36,5°	99,1%	96,5%

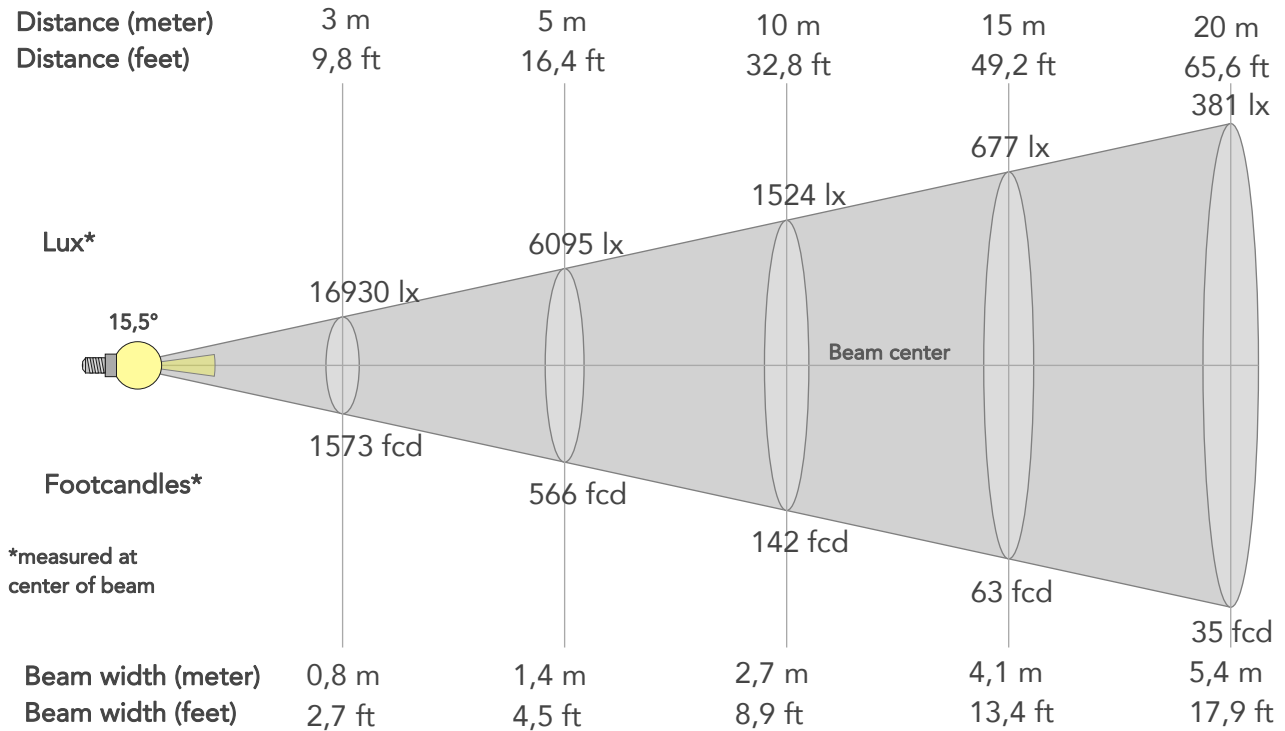

BEAM INTENSITIES AND WIDTHS

Distance	1m	2m	3m	4m	5m	7,5m	10m	15m	20m	25m	30m	40m	50m
Distance	3,3ft	6,6ft	9,8ft	13,1ft	16,4ft	24,6ft	32,8ft	49,2ft	65,6ft	82ft	98,4ft	131,2ft	164ft
Lux	152371lx	38093lx	16930lx	9523lx	6095lx	2709lx	1524lx	677lx	381lx	244lx	169lx	95lx	61lx
Footcand.	14156fcd	3539fcd	1573fcd	885fcd	566fcd	252fcd	142fcd	63fcd	35fcd	23fcd	16fcd	9fcd	6fcd
Beam wid.	0,3m	0,5m	0,8m	1,1m	1,4m	2m	2,7m	4,1m	5,4m	6,8m	8,2m	10,9m	13,6m
Beam wid.	0,9ft	1,8ft	2,7ft	3,6ft	4,5ft	6,7ft	8,9ft	13,4ft	17,9ft	22,3ft	26,8ft	35,7ft	44,7ft

LINEAR DISTRIBUTION DIAGRAM

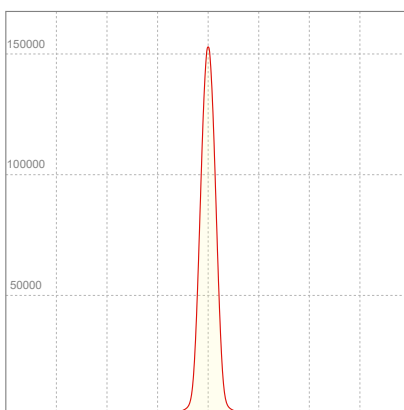

ELECTRICAL SPECIFICATIONS

Input voltage	Input current	Input power	Power FC	Efficiency
226V	1,01A	216,4W	0,95	65lm/W

ISO DIAGRAMS

ISO CANDELA DIAGRAM

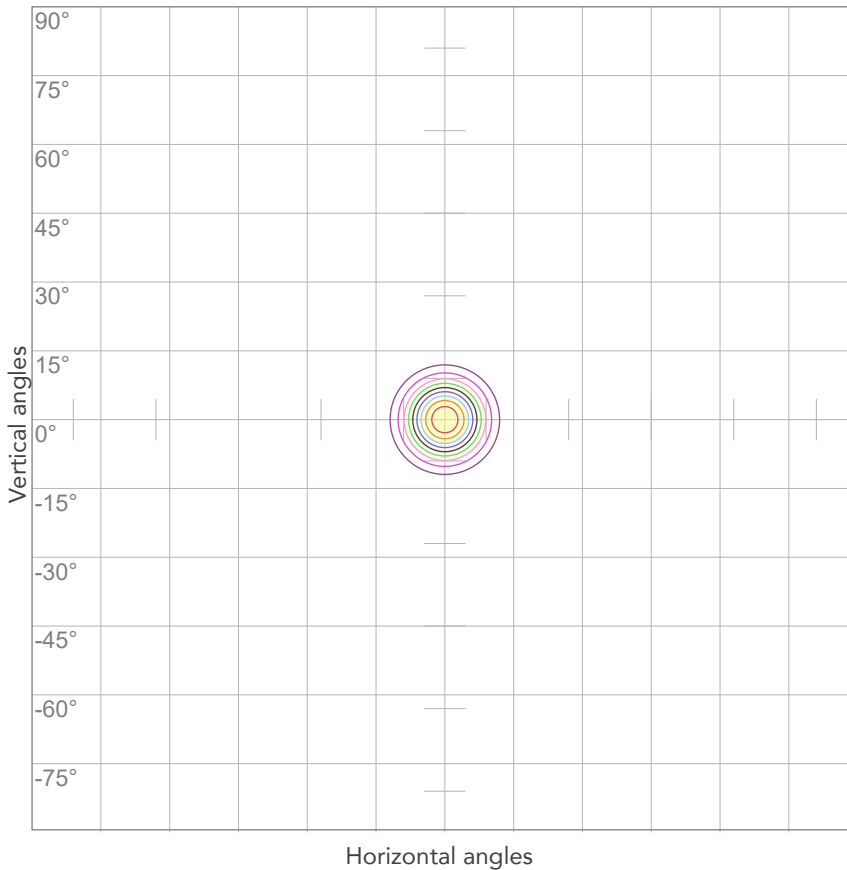

10%	15237 cd
20%	30474 cd
30%	45711 cd
40%	60948 cd
50%	76185 cd
60%	91423 cd
70%	106660 cd
80%	121897 cd

Conditions:

Number of c-planes: 2

Candela at center: 152371 cd

ISO LUX DIAGRAM

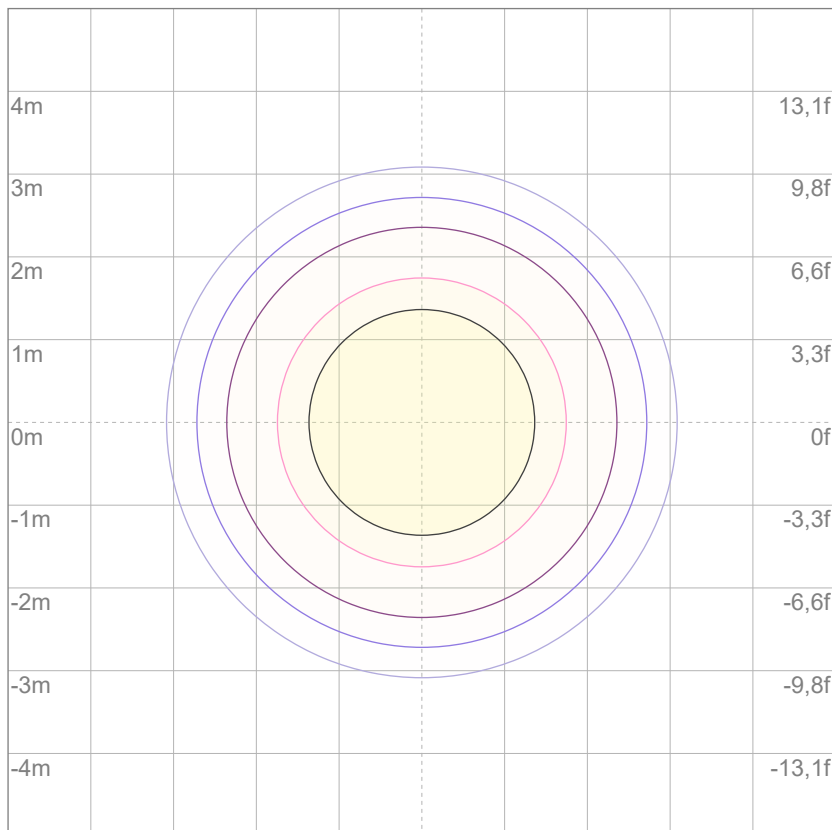

3%	45,7 lx
5%	76,2 lx
10%	152 lx
30%	457 lx
50%	762 lx

Conditions:

Number of c-planes: 2

Lux at center: 1524 lx

Lux distribution on a surface when lamp is mounted at 10 meters from the surface.

Mounting height: 10 meters (33 feet)



Total lumen output:

13637 lm

Peak candela output:

148555 cd

Light quality:

CRI: 85,5

Color temperature:

4075 K

PRODUCT NAME:

ARCSPOTXLFC

MEASURAMENT CONDITIONS:

Beam angle:

15Deg Optic

Target:

4000K

Operator:

Salvatore Giglio

Date and time:

04/11/2024 17:57:57

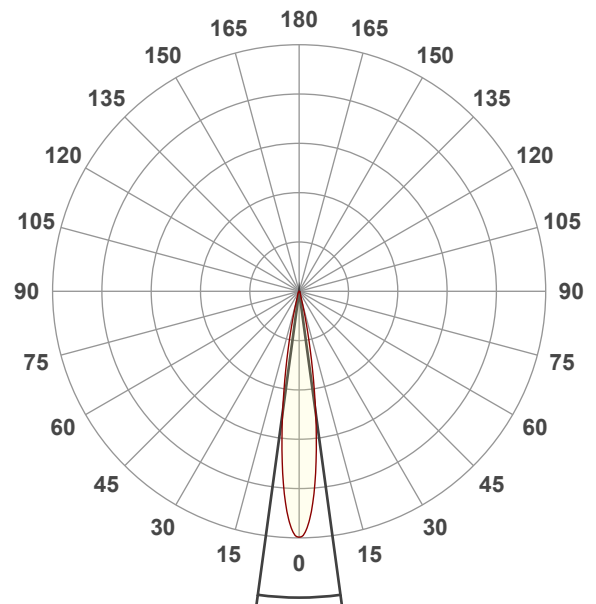

Beam angle 50%: 15,5°

Field angle 10%: 26,7°

Cut off angle 2.5%: 36,4°

Spectra

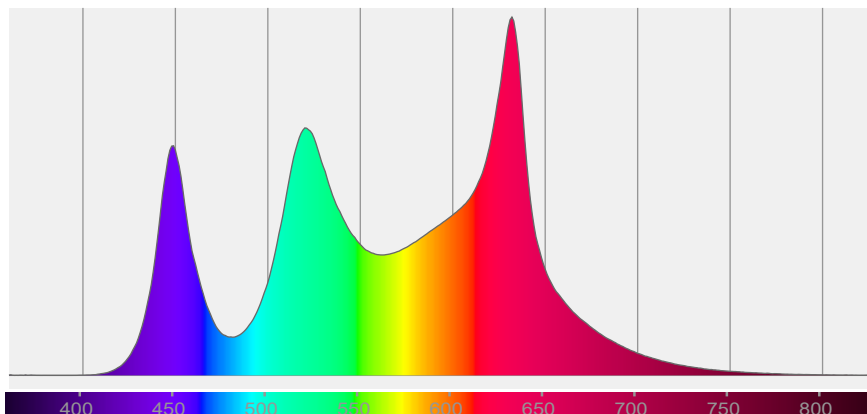

COLOR DETAILS

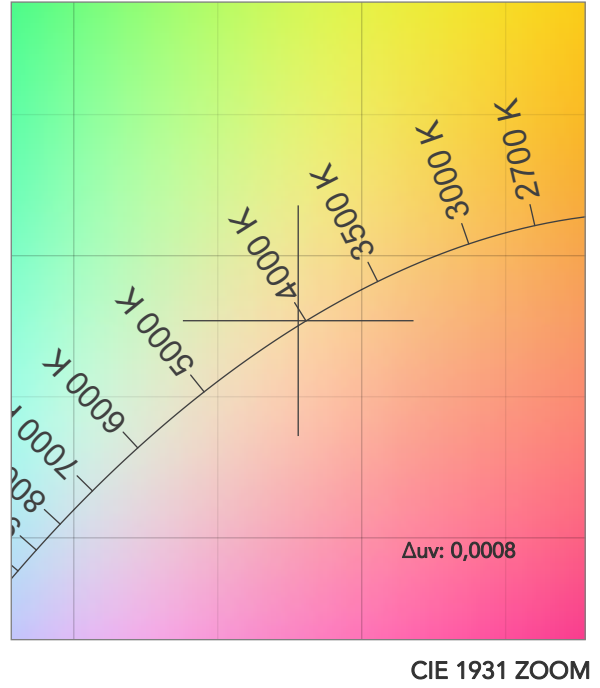
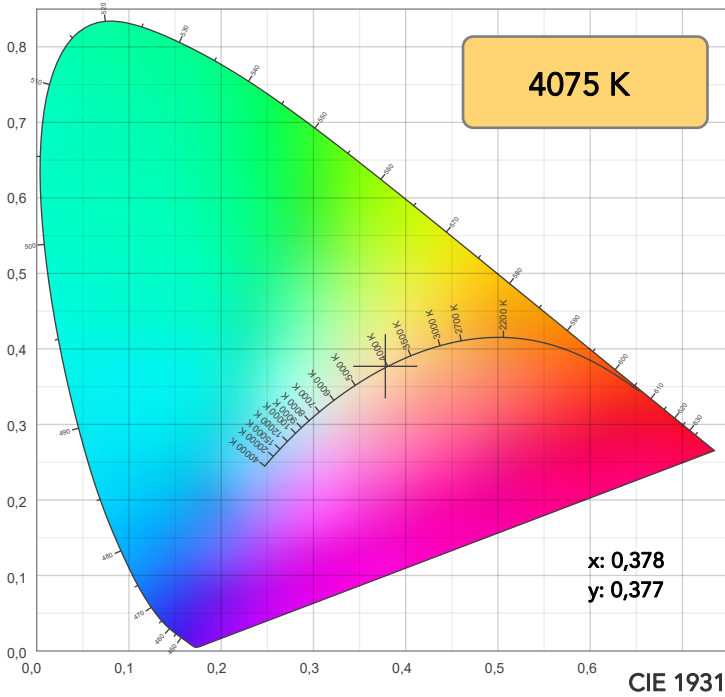

TM30: 88,9

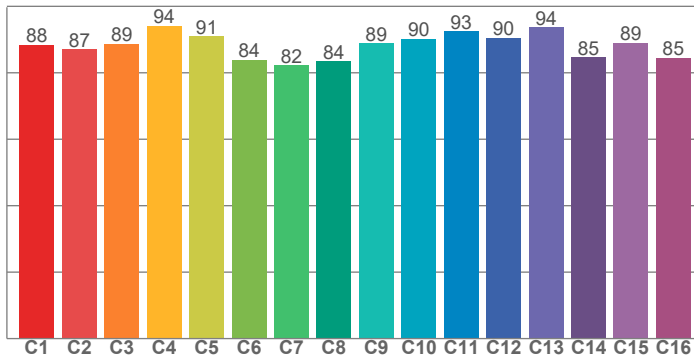

CRI: 85,5 (R1-R8)

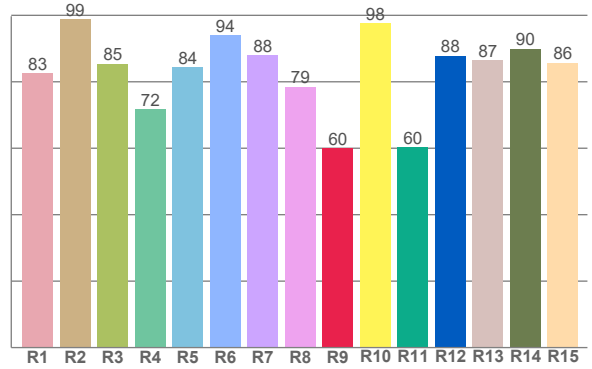

CQS: 89,5

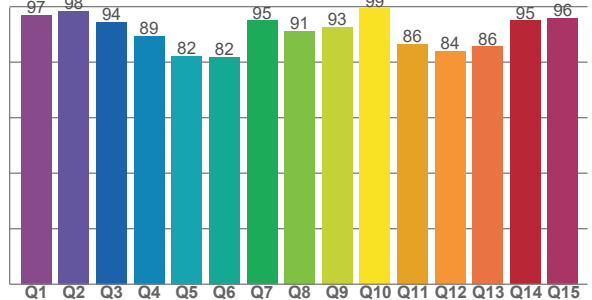

CRI R values, only R1-R8 are used to calculate final CRI value

R1	R2	R3	R4	R5	R6	R7	R8	R9	R10	R11	R12	R13	R14	R15
82,5	98,8	85,4	71,9	84,4	94,0	88,0	78,5	59,9	97,6	60,2	87,8	86,6	90,0	85,8

TM30 C values, 16 binned values out of total of 99 C values

C1	C2	C3	C4	C5	C6	C7	C8	C9	C10	C11	C12	C13	C14	C15	C16
88,4	87,1	88,7	94,1	90,9	83,9	82,2	83,5	88,8	90,2	92,5	90,5	93,8	84,7	89,0	84,6

CQS Q values

Q1	Q2	Q3	Q4	Q5	Q6	Q7	Q8	Q9	Q10	Q11	Q12	Q13	Q14	Q15
97,0	98,5	94,4	89,5	82,2	81,9	95,1	91,3	92,6	99,4	86,5	83,9	85,6	95,0	95,9

COLOR PARAMETERS

Color temperature	Color rendering index	Red component	Color fidelity	Color gamut	Color quality scale	Television lighting index	Color coordinate cie 1931	Color coordinate cie 1931	Color deviation from black body
CCT	CRI	CRI R9	TM30 Rf	TM30 Rg	CQS	TLCI	x	y	Δuv
4075 K	85,5	59,9	88,9	109,8	89,5	70	0,378	0,377	0,0008

TM30 DETAILS

Rf 88,9
Fidelity index Rf

Rg 109,8
Gammut index

Hue Bin	R _f	Graphic shifts (%)	
		Chroma	Hue
1	88	6%	-2%
2	87	5%	-5%
3	89	3%	-3%
4	94	0%	-1%
5	91	2%	4%
6	84	9%	7%
7	82	12%	1%
8	84	9%	-2%
9	89	6%	-5%
10	90	-1%	-6%
11	93	1%	2%
12	90	3%	3%
13	94	4%	1%
14	85	4%	8%
15	89	7%	1%
16	85	9%	-4%

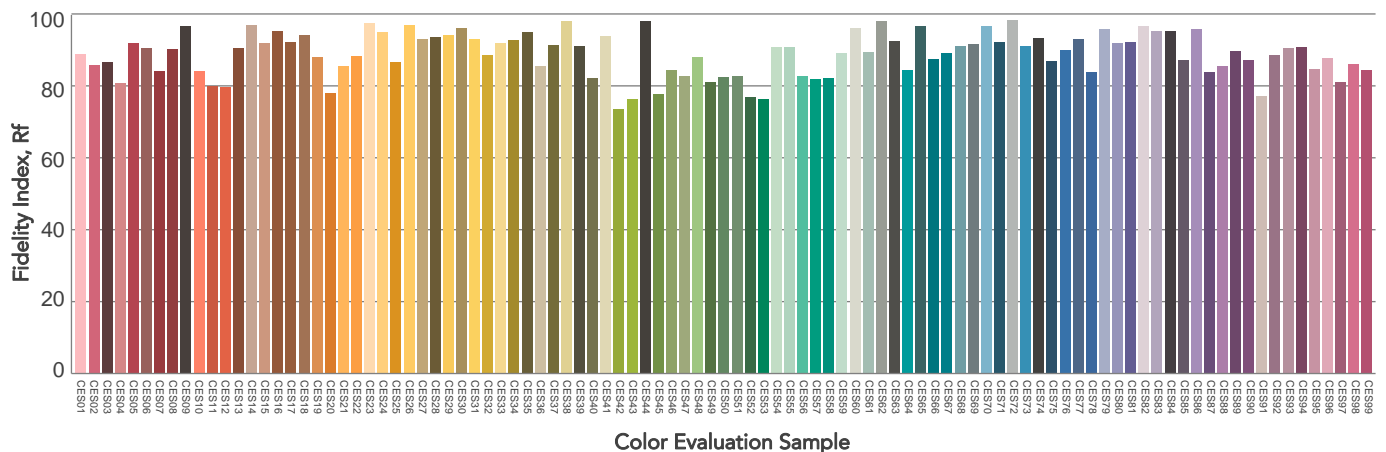
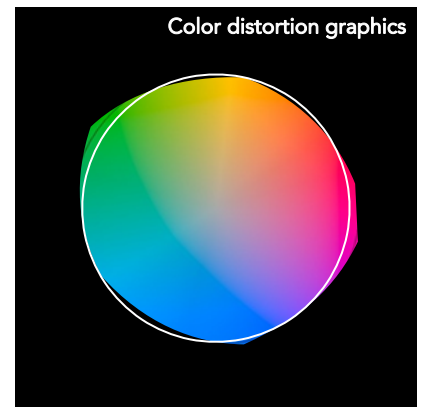
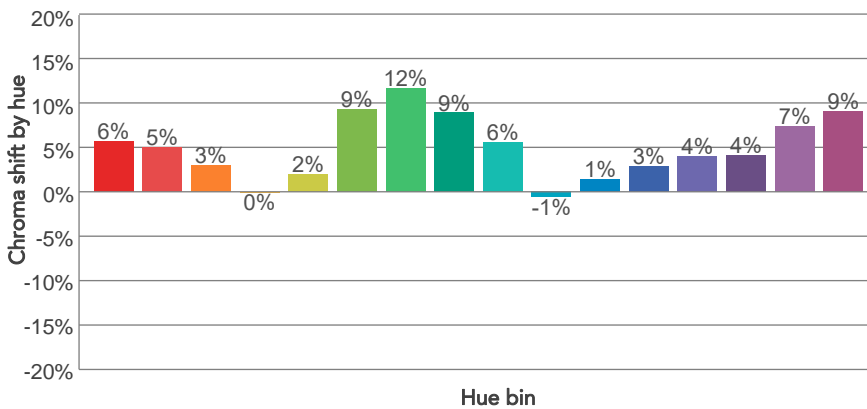
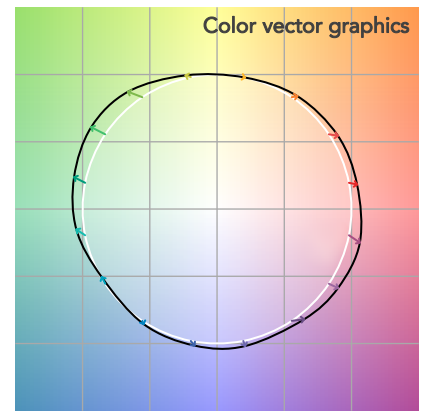
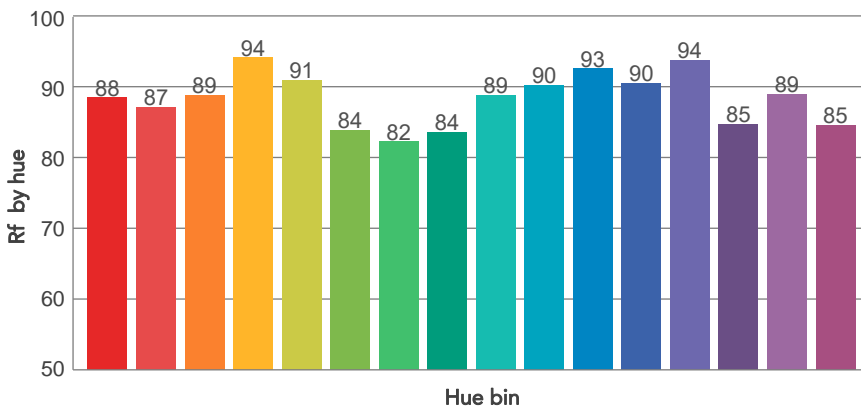
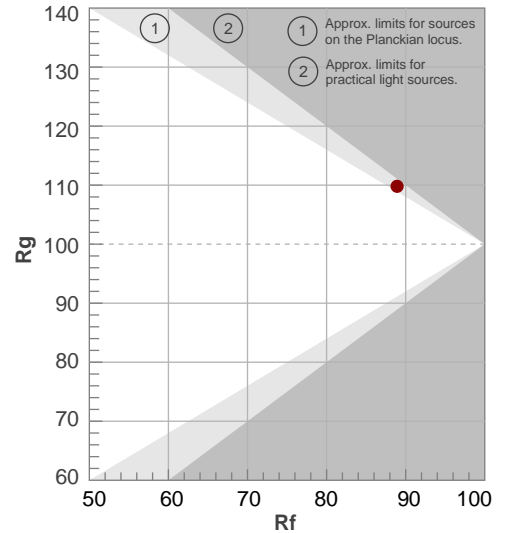

BEAM DETAILS



Beam angle 50%	Field angle 10%	Cut off angle 2,5%	Intensity ratio in 120° cone	Intensity ratio in 90° cone
15,5°	26,7°	36,4°	99,2%	96,8%

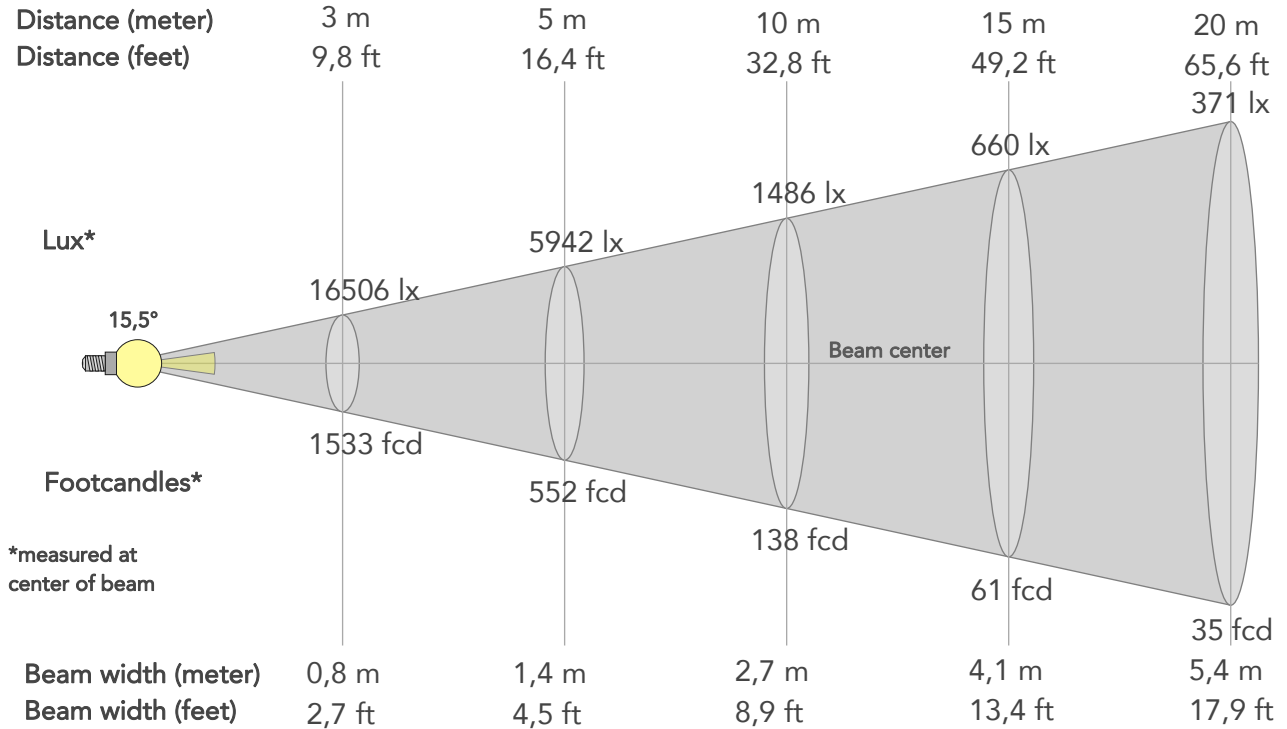

BEAM INTENSITIES AND WIDTHS

Distance	1m	2m	3m	4m	5m	7,5m	10m	15m	20m	25m	30m	40m	50m
Distance	3,3ft	6,6ft	9,8ft	13,1ft	16,4ft	24,6ft	32,8ft	49,2ft	65,6ft	82ft	98,4ft	131,2ft	164ft
Lux	14855lx	37139lx	16506lx	9285lx	5942lx	2641lx	1486lx	660lx	371lx	238lx	165lx	93lx	59lx
Footcand.	13801fcd	3450fcd	1533fcd	863fcd	552fcd	245fcd	138fcd	61fcd	35fcd	22fcd	15fcd	9fcd	6fcd
Beam wid.	0,3m	0,5m	0,8m	1,1m	1,4m	2m	2,7m	4,1m	5,4m	6,8m	8,2m	10,9m	13,6m
Beam wid.	0,9ft	1,8ft	2,7ft	3,6ft	4,5ft	6,7ft	8,9ft	13,4ft	17,9ft	22,3ft	26,8ft	35,7ft	44,7ft

LINEAR DISTRIBUTION DIAGRAM

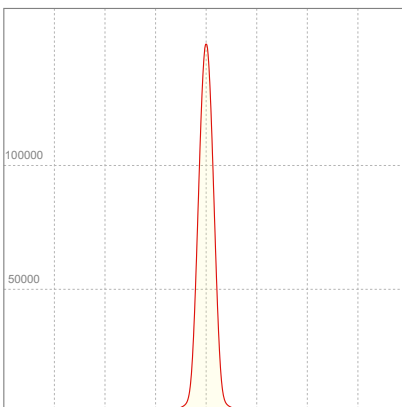

ELECTRICAL SPECIFICATIONS

Input voltage	Input current	Input power	Power FC	Efficiency
226V	1,00A	213,9W	0,95	64lm/W

ISO DIAGRAMS

ISO CANDELA DIAGRAM

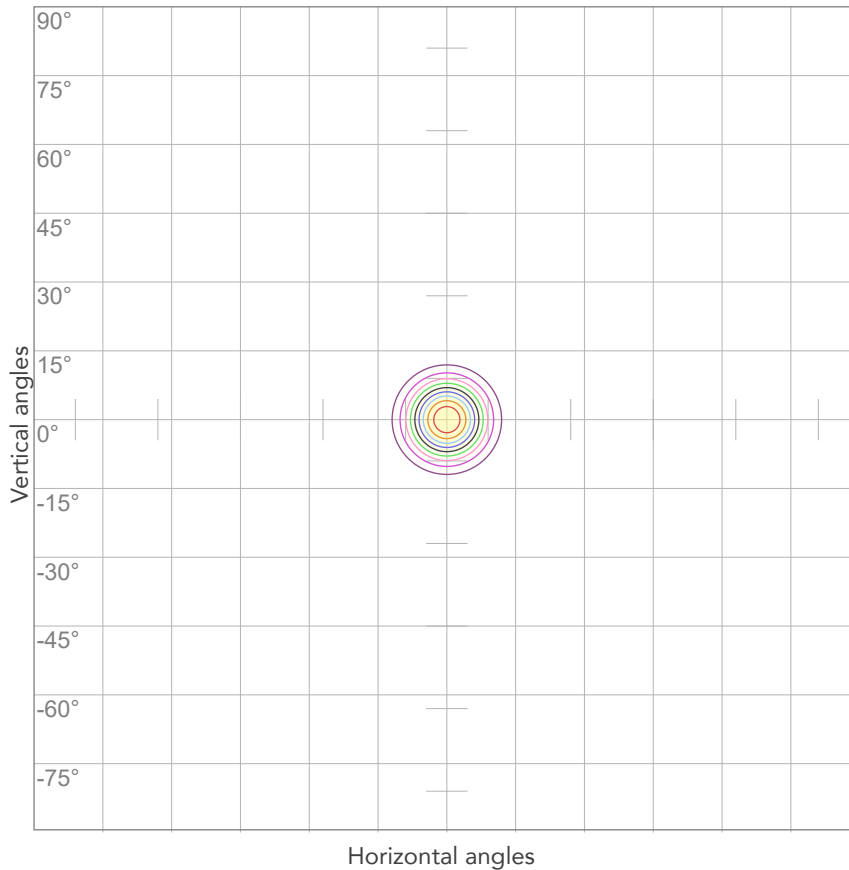

10%	14856 cd
20%	29711 cd
30%	44567 cd
40%	59422 cd
50%	74278 cd
60%	89133 cd
70%	103989 cd
80%	118844 cd

Conditions:

Number of c-planes: 2

Candela at center: 148555 cd

ISO LUX DIAGRAM

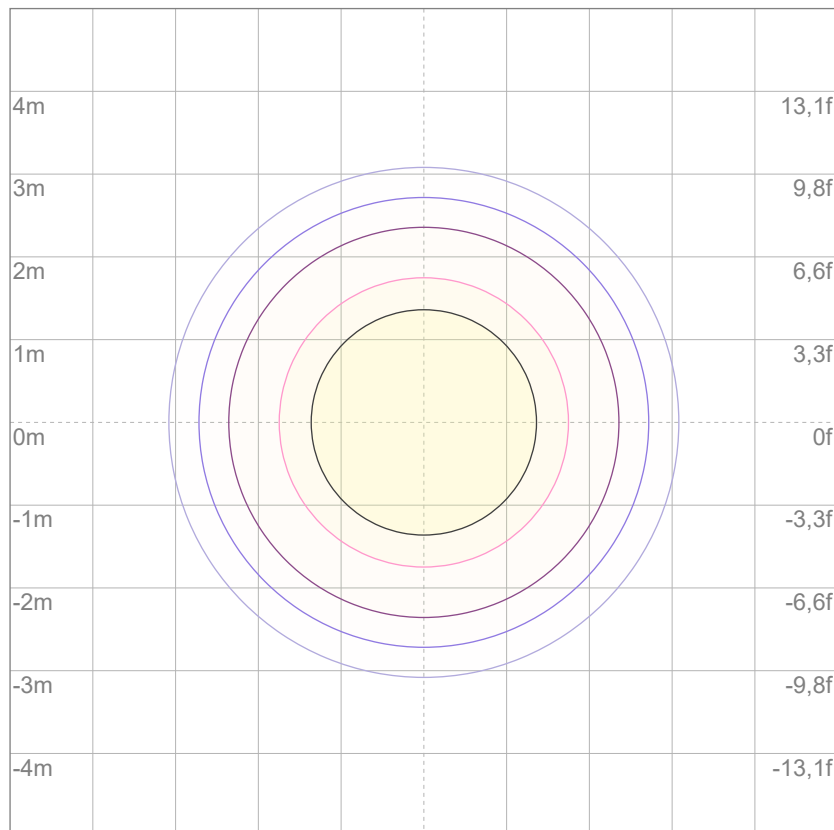

3%	44,6 lx
5%	74,3 lx
10%	149 lx
30%	446 lx
50%	743 lx

Conditions:

Number of c-planes: 2

Lux at center: 1486 lx

Lux distribution on a surface when lamp is mounted at 10 meters from the surface.

Mounting height: 10 meters (33 feet)



Total lumen output:

13531 lm

Peak candela output:

145816 cd

Light quality:

CRI: 87,0

Color temperature:

5685 K

PRODUCT NAME:

ARCSPOTXLFC

MEASURAMENT CONDITIONS:

Beam angle:

15Deg Optic

Target:

5600K

Operator:

Salvatore Giglio

Date and time:

04/11/2024 17:54:44

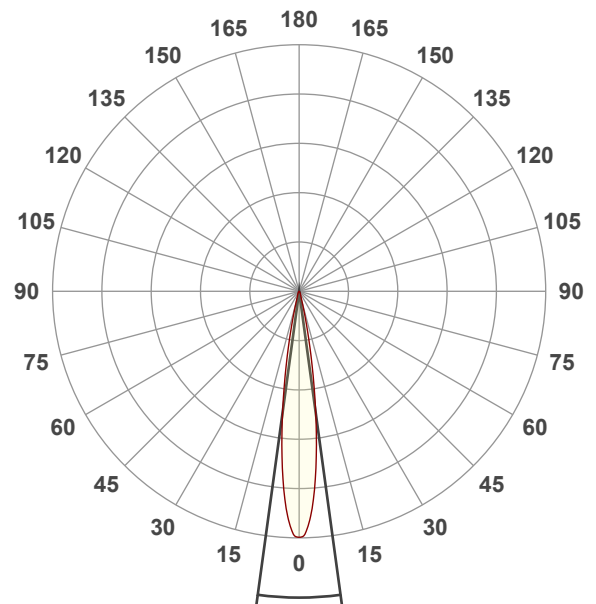

Beam angle 50%: 15,5°

Field angle 10%: 26,7°

Cut off angle 2.5%: 36,5°

Spectra

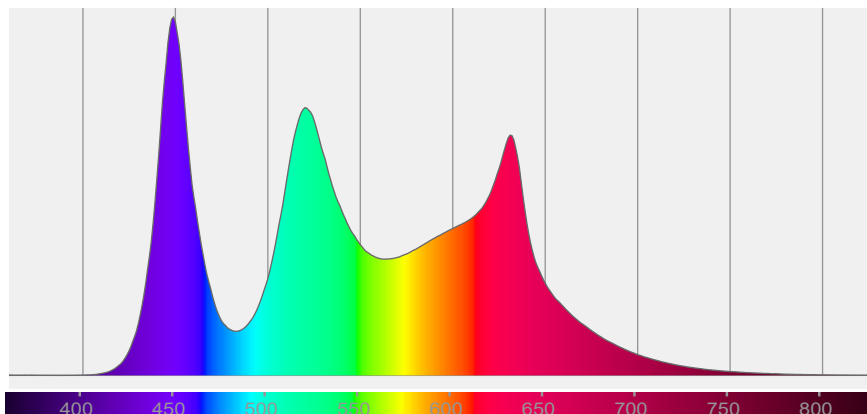

COLOR DETAILS

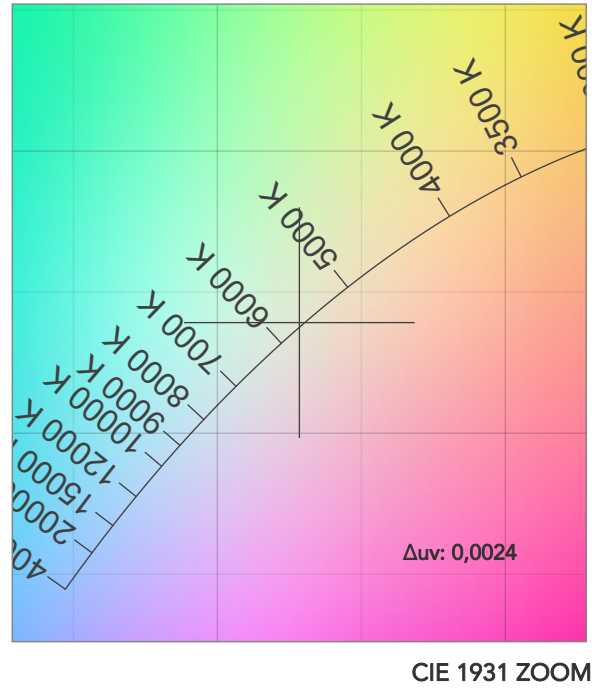
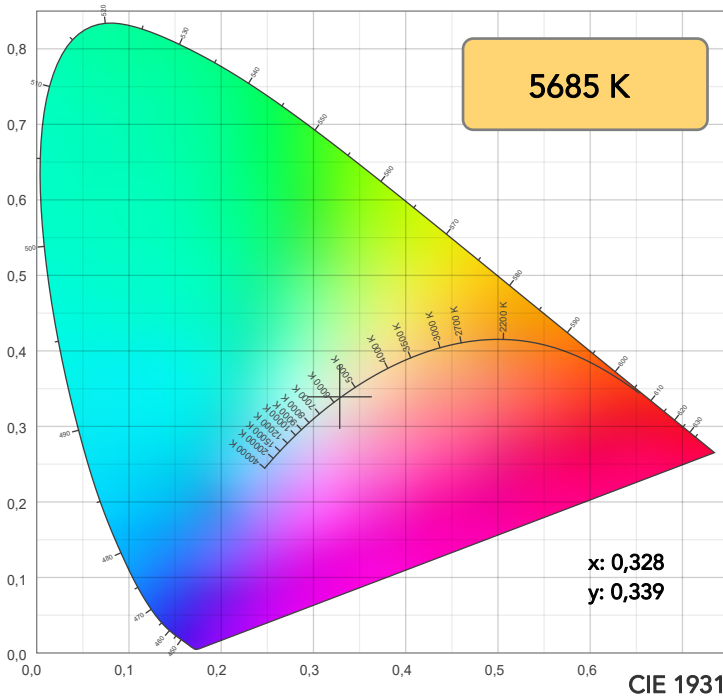

TM30: 88,4

CRI: 87,0 (R1-R8)

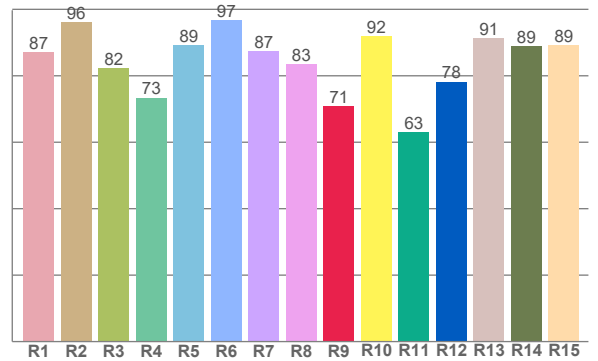
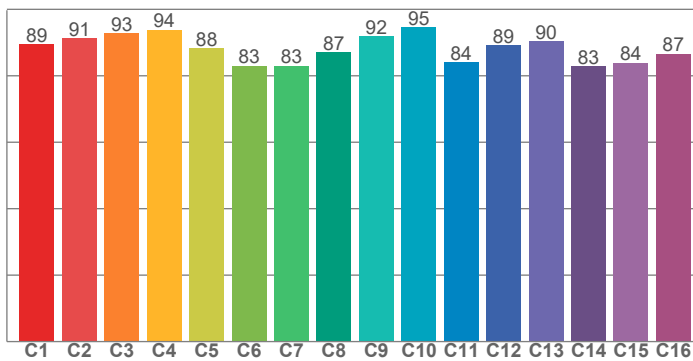

CRI R values, only R1-R8 are used to calculate final CRI value

R1	R2	R3	R4	R5	R6	R7	R8	R9	R10	R11	R12	R13	R14	R15
87,1	96,2	82,4	73,4	89,3	96,7	87,4	83,5	70,8	92,0	62,9	78,2	91,2	88,8	89,2

TM30 C values, 16 binned values out of total of 99 C values

C1	C2	C3	C4	C5	C6	C7	C8	C9	C10	C11	C12	C13	C14	C15	C16
89,4	91,3	92,8	93,8	88,3	83,0	83,0	87,0	91,9	94,5	84,1	89,2	90,4	82,9	83,9	86,6

CQS Q values

Q1	Q2	Q3	Q4	Q5	Q6	Q7	Q8	Q9	Q10	Q11	Q12	Q13	Q14	Q15
98,8	94,9	85,5	96,7	86,6	83,8	94,6	92,3	89,4	93,2	93,7	90,7	90,6	96,1	97,6

CQS: 91,2

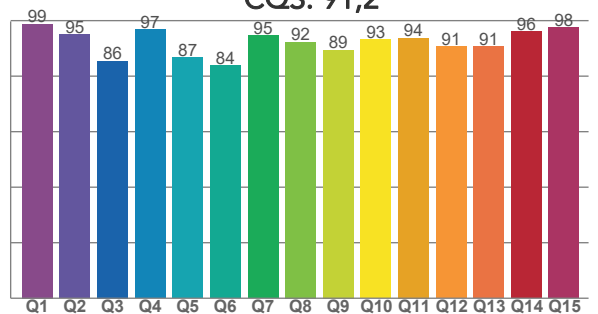

COLOR PARAMETERS

Color temperature	Color rendering index	Red component	Color fidelity	Color gamut	Color quality scale	Television lighting index	Color coordinate cie 1931	Color coordinate cie 1931	Color deviation from black body
CCT	CRI	CRI R9	TM30 Rf	TM30 Rg	CQS	TLCI	x	y	Δuv
5685 K	87,0	70,8	88,4	110,2	91,2	78	0,328	0,339	0,0024

TM30 DETAILS

Rf 88,4
Fidelity index Rf

Rg 110,2
Gammut index

Hue Bin	R _f	Graphic shifts (%)	
		Chroma	Hue
1	89	4%	-2%
2	91	4%	-2%
3	93	3%	0%
4	94	1%	3%
5	88	3%	5%
6	83	11%	6%
7	83	11%	0%
8	87	6%	-3%
9	92	1%	-4%
10	95	-2%	-1%
11	84	0%	10%
12	89	2%	7%
13	90	6%	6%
14	83	7%	8%
15	84	15%	-1%
16	87	8%	-1%

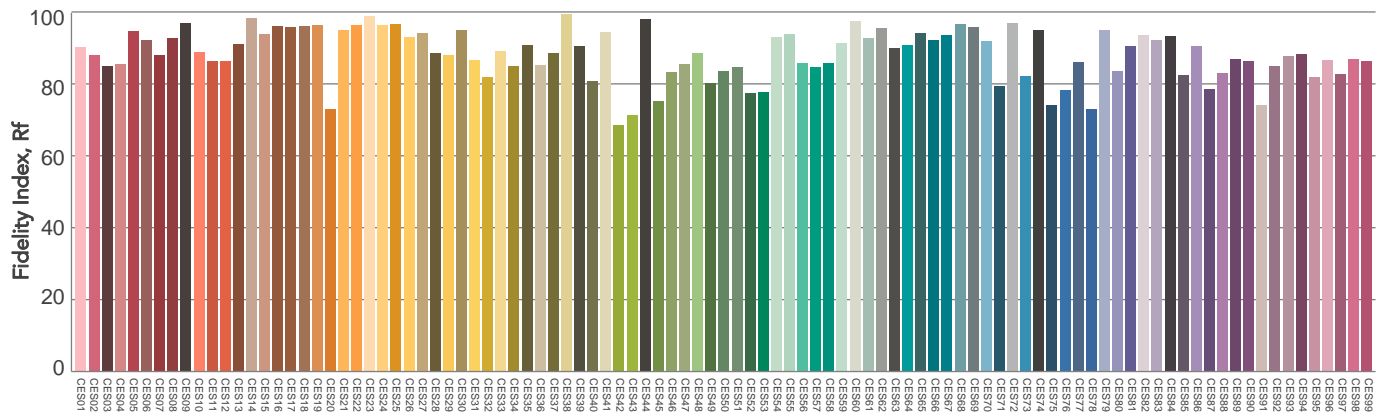
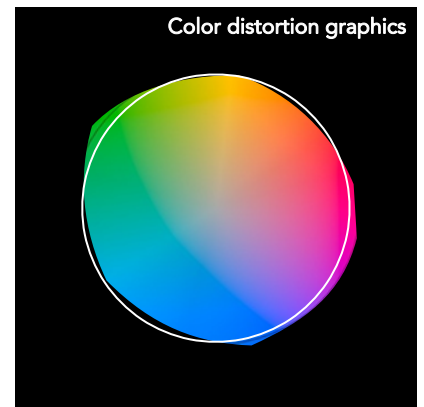
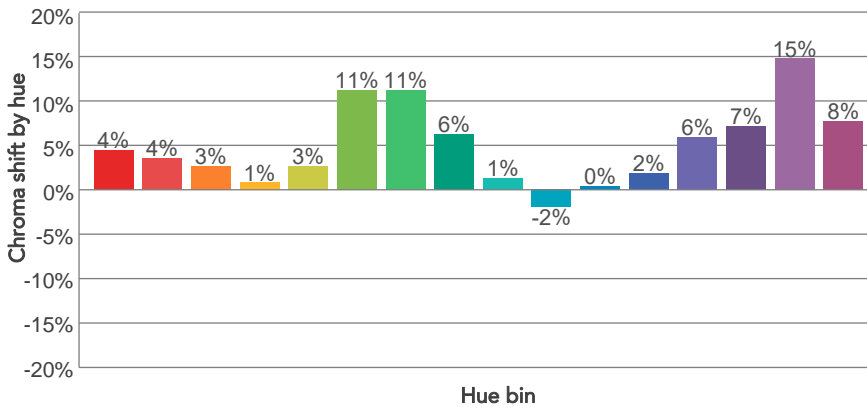
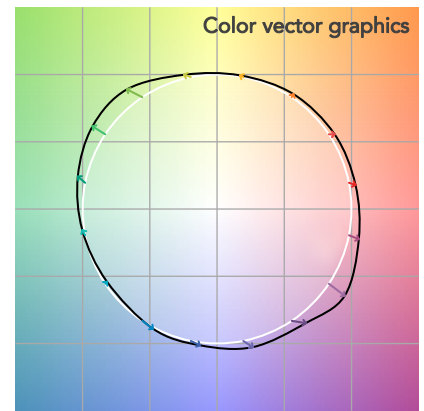
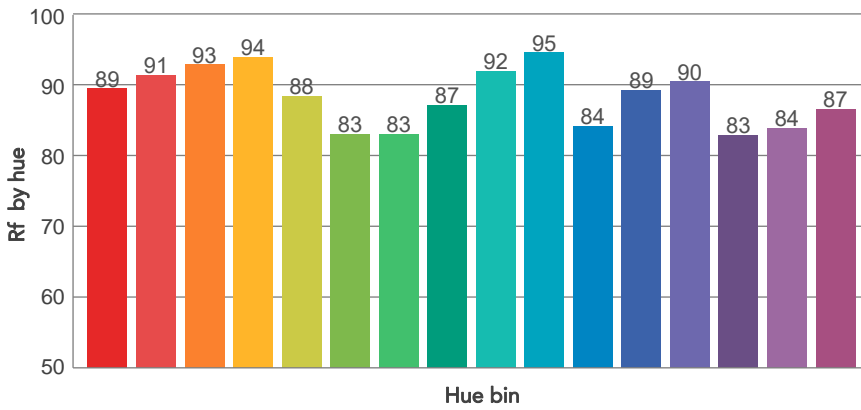
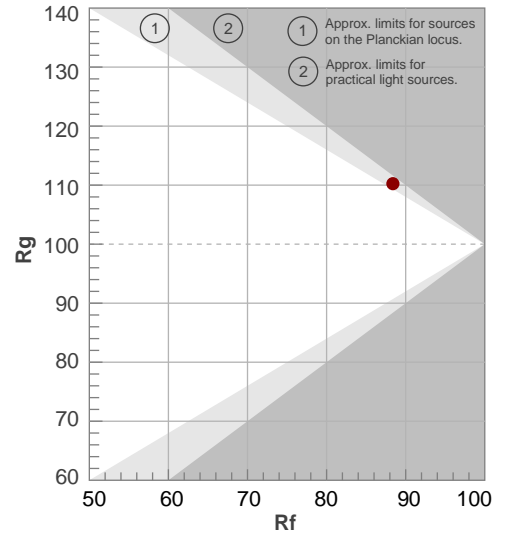

BEAM DETAILS



Beam angle 50%	Field angle 10%	Cut off angle 2,5%	Intensity ratio in 120° cone	Intensity ratio in 90° cone
15,5°	26,7°	36,5°	99,1%	96,5%

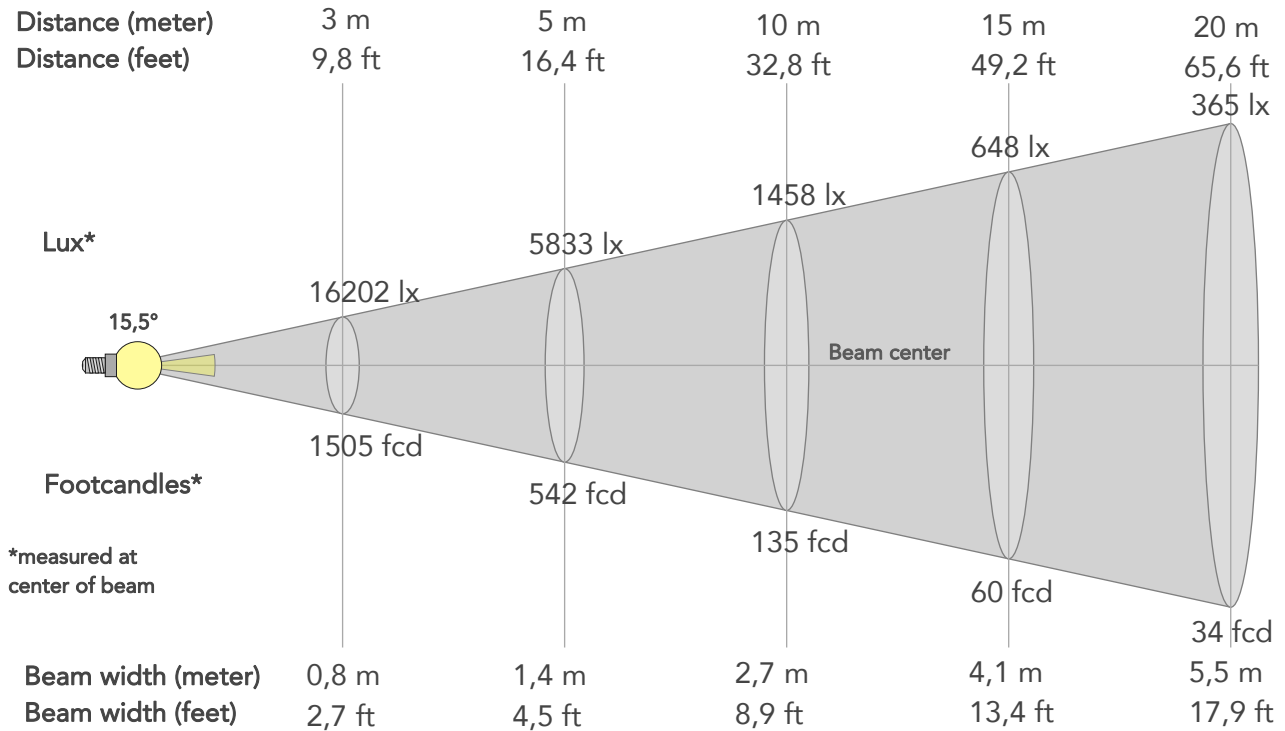

BEAM INTENSITIES AND WIDTHS

Distance	1m	2m	3m	4m	5m	7,5m	10m	15m	20m	25m	30m	40m	50m
Distance	3,3ft	6,6ft	9,8ft	13,1ft	16,4ft	24,6ft	32,8ft	49,2ft	65,6ft	82ft	98,4ft	131,2ft	164ft
Lux	145816lx	36454lx	16202lx	9113lx	5833lx	2592lx	1458lx	648lx	365lx	233lx	162lx	91lx	58lx
Footcand.	13547fcd	3387fcd	1505fcd	847fcd	542fcd	241fcd	135fcd	60fcd	34fcd	22fcd	15fcd	8fcd	5fcd
Beam wid.	0,3m	0,5m	0,8m	1,1m	1,4m	2m	2,7m	4,1m	5,5m	6,8m	8,2m	10,9m	13,6m
Beam wid.	0,9ft	1,8ft	2,7ft	3,6ft	4,5ft	6,7ft	8,9ft	13,4ft	17,9ft	22,4ft	26,8ft	35,8ft	44,7ft

LINEAR DISTRIBUTION DIAGRAM

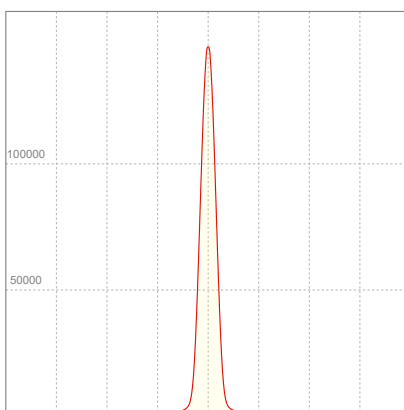

ELECTRICAL SPECIFICATIONS

Input voltage	Input current	Input power	Power FC	Efficiency
226V	1,20A	209,2W	0,77	65lm/W

ISO DIAGRAMS

ISO CANDELA DIAGRAM

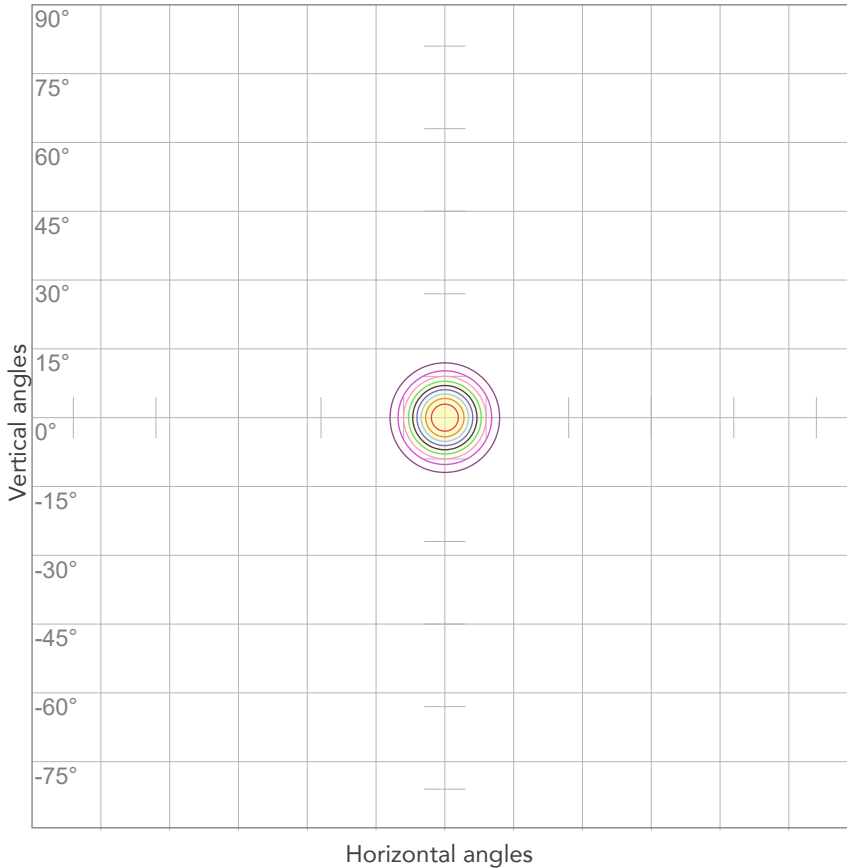

10%	14582 cd
20%	29163 cd
30%	43745 cd
40%	58326 cd
50%	72908 cd
60%	87489 cd
70%	102071 cd
80%	116653 cd

Conditions:

Number of c-planes: 2

Candela at center: 145816 cd

ISO LUX DIAGRAM

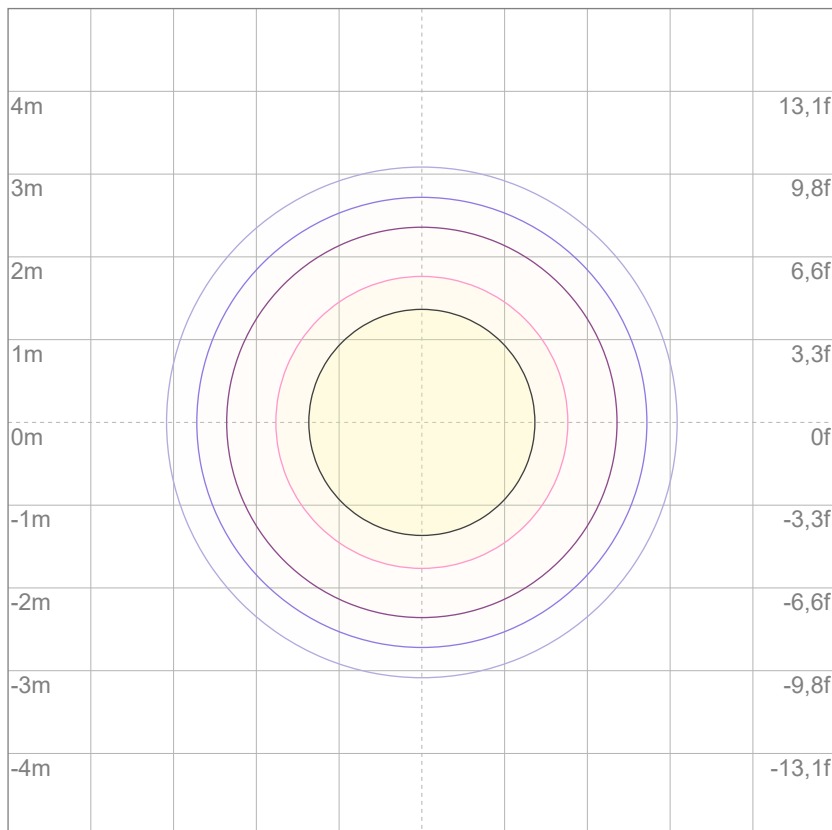

3%	43,7 lx
5%	72,9 lx
10%	146 lx
30%	437 lx
50%	729 lx

Conditions:

Number of c-planes: 2

Lux at center: 1458 lx

Lux distribution on a surface when lamp is mounted at 10 meters from the surface.

Mounting height: 10 meters (33 feet)



Total lumen output:

13210 lm

Peak candela output:

144459 cd

Light quality:

CRI: 87,5

Color temperature:

6053 K

PRODUCT NAME:

ARCSPOTXLFC

MEASURAMENT CONDITIONS:

Beam angle:

15Deg Optic

Target:

6000K

Operator:

Salvatore Giglio

Date and time:

04/11/2024 18:01:31

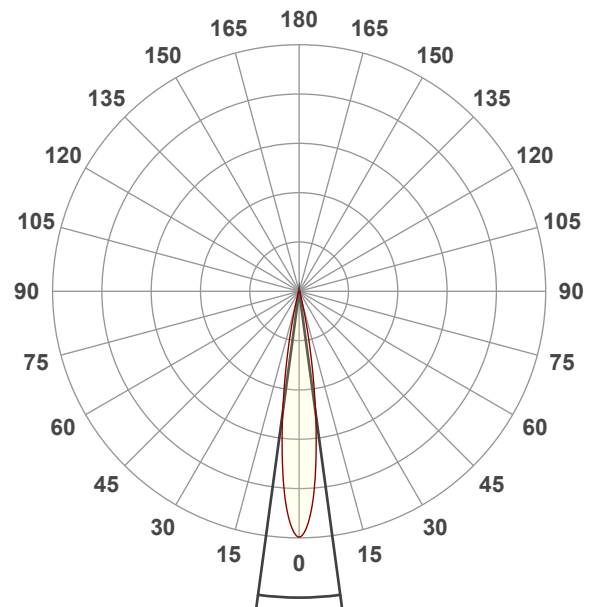

Beam angle 50%: 15,4°

Field angle 10%: 26,6°

Cut off angle 2.5%: 36,3°

Spectra

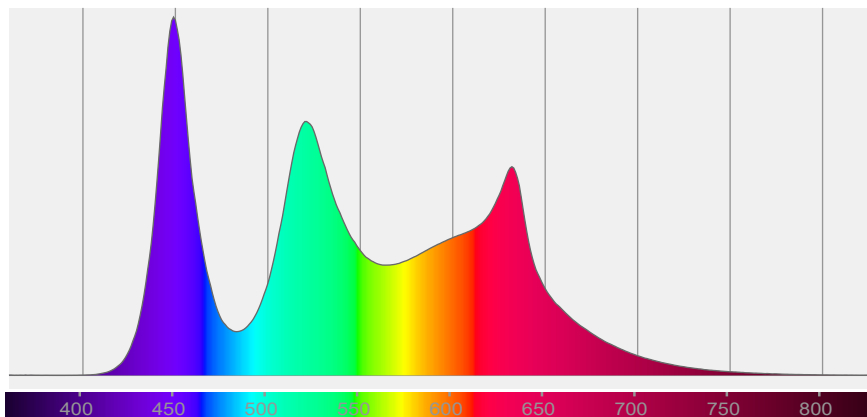

COLOR DETAILS

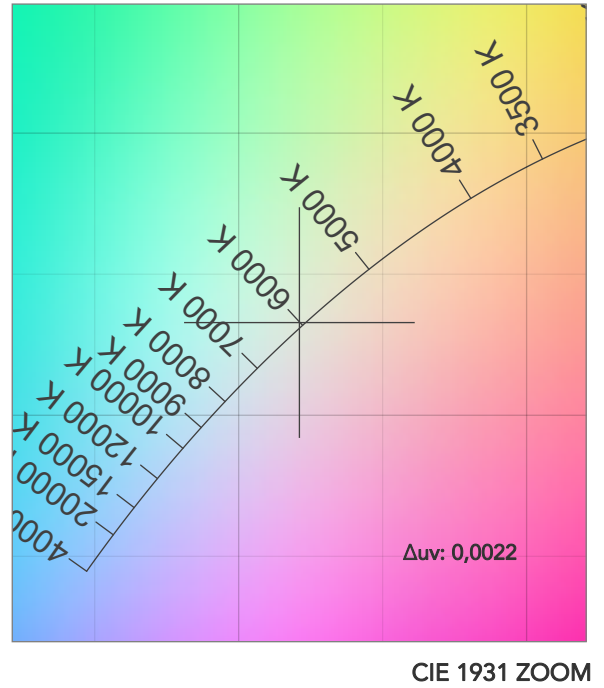
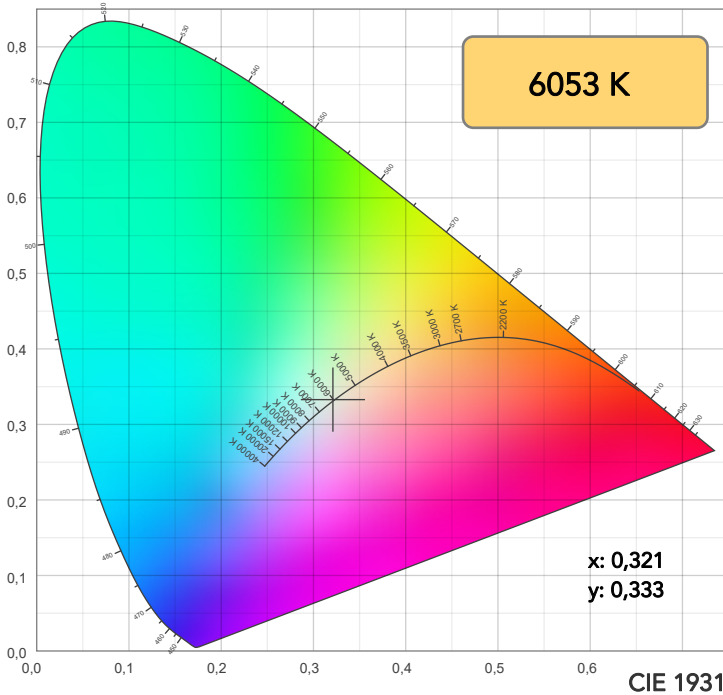

TM30: 88,5

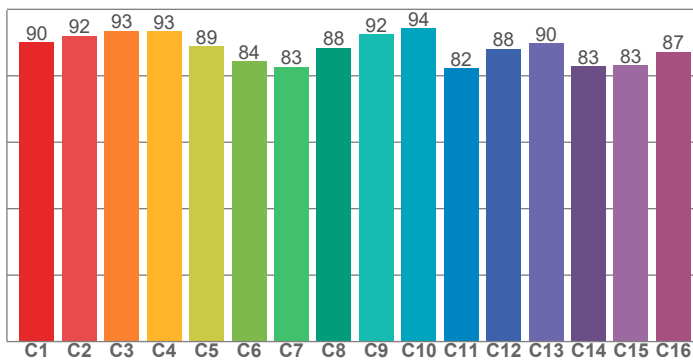

CRI: 87,5 (R1-R8)

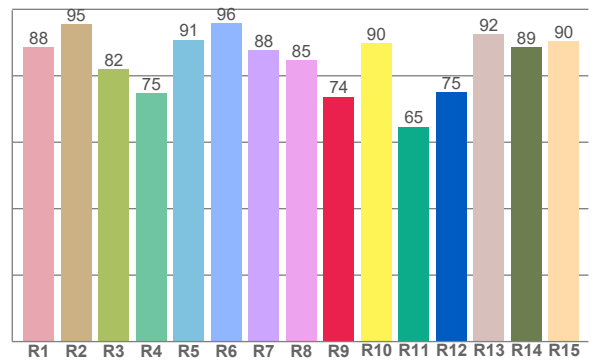

CRI R values, only R1-R8 are used to calculate final CRI value

R1	R2	R3	R4	R5	R6	R7	R8	R9	R10	R11	R12	R13	R14	R15
88,5	95,4	81,9	74,8	90,9	95,8	87,8	84,8	73,7	89,8	64,7	75,1	92,4	88,6	90,4

TM30 C values, 16 binned values out of total of 99 C values

C1	C2	C3	C4	C5	C6	C7	C8	C9	C10	C11	C12	C13	C14	C15	C16
90,1	92,1	93,5	93,4	88,9	84,4	82,7	88,4	92,4	94,3	82,2	88,2	89,8	82,9	83,1	87,2

CQS Q values

Q1	Q2	Q3	Q4	Q5	Q6	Q7	Q8	Q9	Q10	Q11	Q12	Q13	Q14	Q15
98,8	94,8	84,3	96,5	88,5	85,0	94,6	92,7	89,0	92,3	94,9	91,7	91,2	96,5	97,8

CQS: 91,4

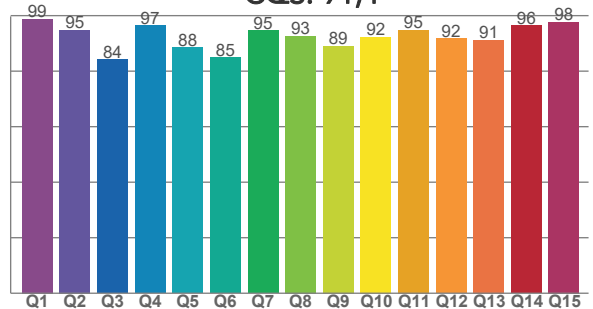

COLOR PARAMETERS

Color temperature	Color rendering index	Red component	Color fidelity	Color gamut	Color quality scale	Television lighting index	Color coordinate cie 1931	Color coordinate cie 1931	Color deviation from black body
CCT	CRI	CRI R9	TM30 Rf	TM30 Rg	CQS	TLCI	x	y	Δuv
6053 K	87,5	73,7	88,5	109,7	91,4	80	0,321	0,333	0,0022

TM30 DETAILS

Rf 88,5
Fidelity index Rf

Rg 109,7
Gammut index

Hue Bin	R _f	Graphic shifts (%)	
		Chroma	Hue
1	90	4%	-2%
2	92	3%	-2%
3	93	2%	1%
4	93	0%	3%
5	89	2%	4%
6	84	10%	6%
7	83	12%	0%
8	88	5%	-3%
9	92	0%	-3%
10	94	-2%	1%
11	82	0%	11%
12	88	2%	8%
13	90	6%	7%
14	83	7%	8%
15	83	16%	-1%
16	87	7%	-1%

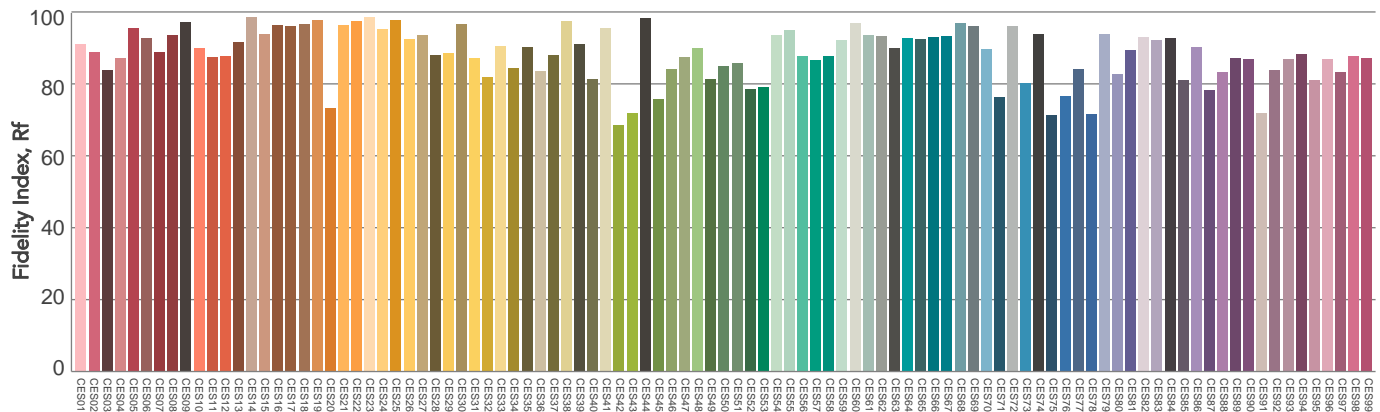
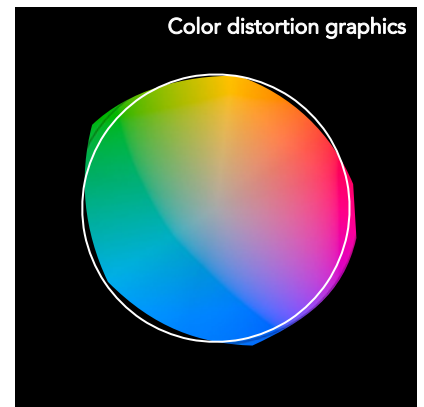
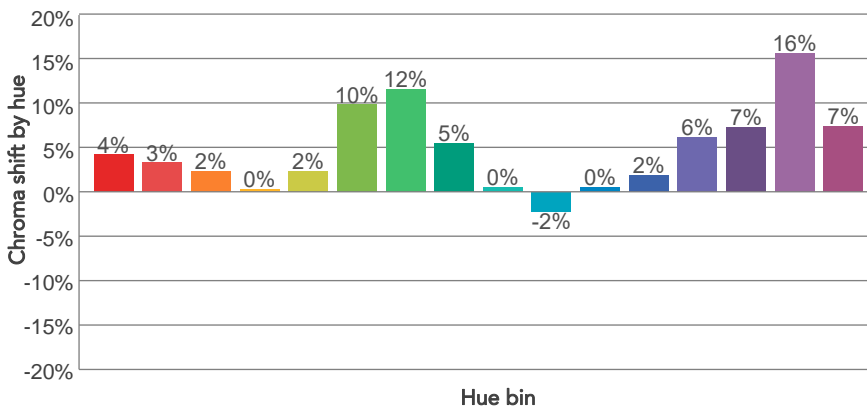
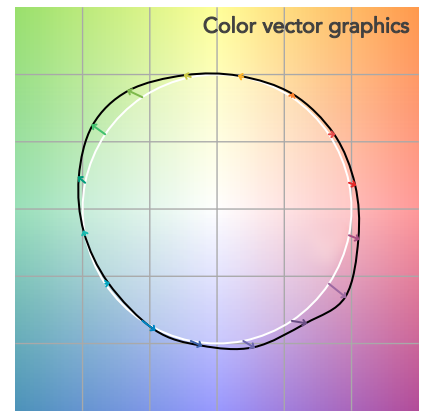
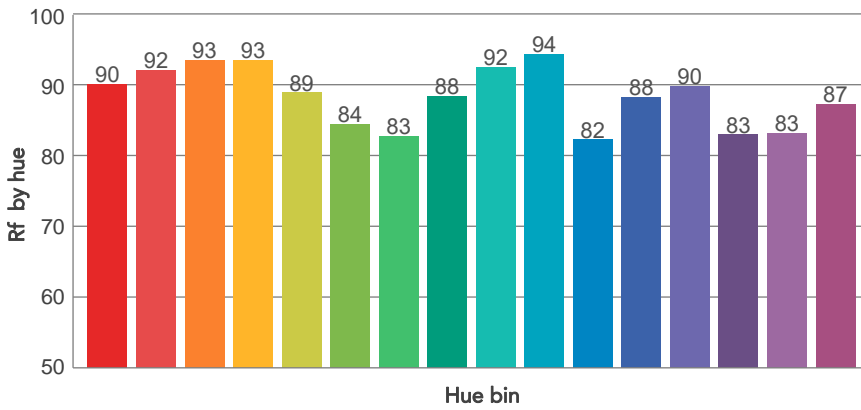
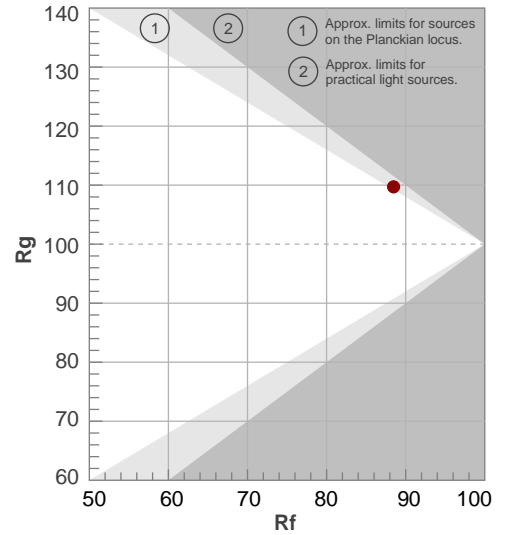

BEAM DETAILS



Beam angle 50%	Field angle 10%	Cut off angle 2,5%	Intensity ratio in 120° cone	Intensity ratio in 90° cone
15,4°	26,6°	36,3°	99,2%	96,7%

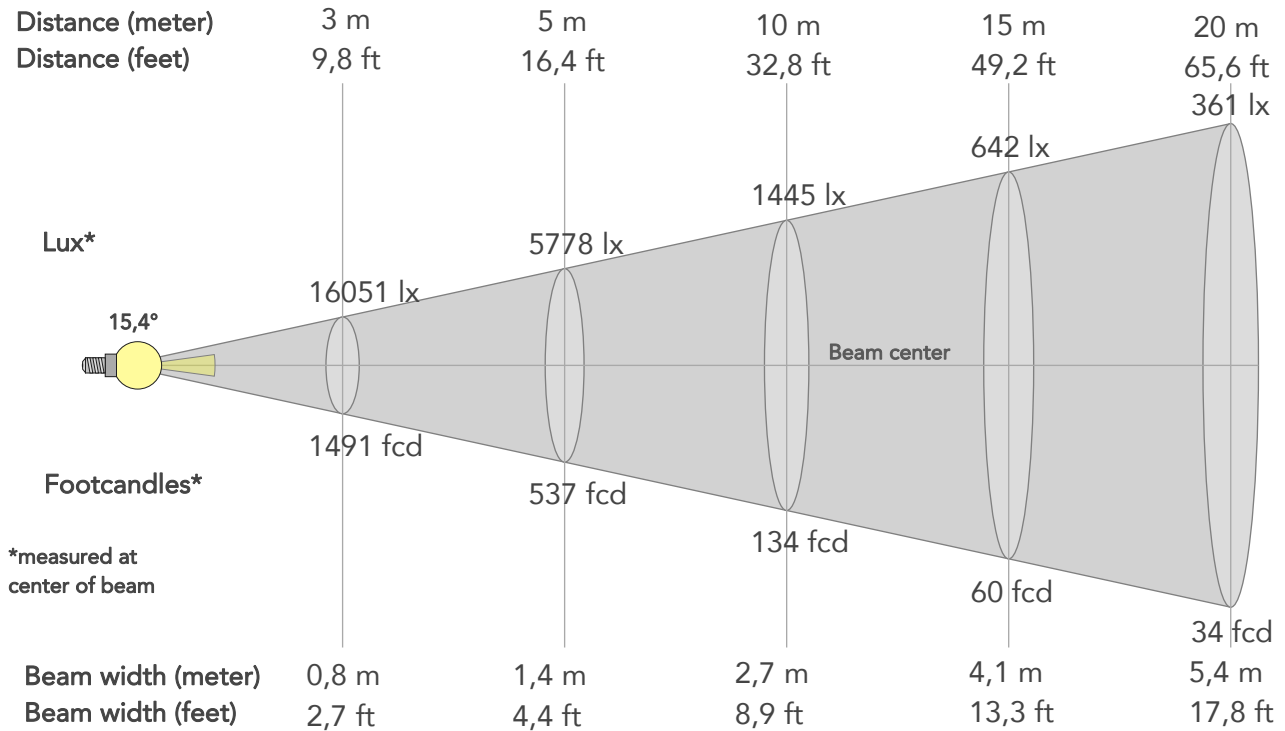

BEAM INTENSITIES AND WIDTHS

Distance	1m	2m	3m	4m	5m	7,5m	10m	15m	20m	25m	30m	40m	50m
Distance	3,3ft	6,6ft	9,8ft	13,1ft	16,4ft	24,6ft	32,8ft	49,2ft	65,6ft	82ft	98,4ft	131,2ft	164ft
Lux	144459lx	36115lx	16051lx	9029lx	5778lx	2568lx	1445lx	642lx	361lx	231lx	161lx	90lx	58lx
Footcand.	13421fcd	3355fcd	1491fcd	839fcd	537fcd	239fcd	134fcd	60fcd	34fcd	21fcd	15fcd	8fcd	5fcd
Beam wid.	0,3m	0,5m	0,8m	1,1m	1,4m	2m	2,7m	4,1m	5,4m	6,8m	8,1m	10,8m	13,5m
Beam wid.	0,9ft	1,8ft	2,7ft	3,5ft	4,4ft	6,7ft	8,9ft	13,3ft	17,8ft	22,2ft	26,7ft	35,5ft	44,4ft

LINEAR DISTRIBUTION DIAGRAM

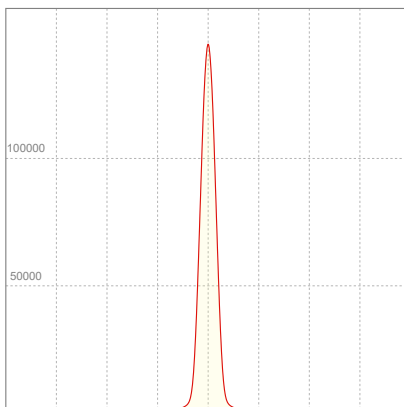

ELECTRICAL SPECIFICATIONS

Input voltage	Input current	Input power	Power FC	Efficiency
226V	1,14A	213,2W	0,82	62lm/W

ISO DIAGRAMS

ISO CANDELA DIAGRAM

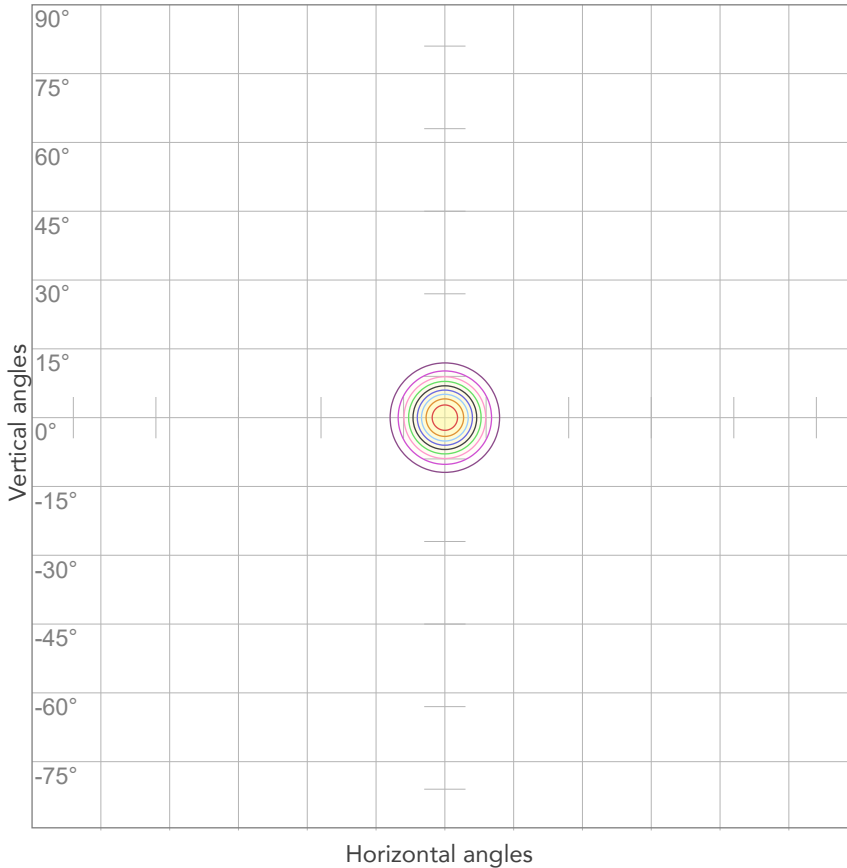

10%	14446 cd
20%	28892 cd
30%	43338 cd
40%	57784 cd
50%	72230 cd
60%	86675 cd
70%	101121 cd
80%	115567 cd

Conditions:

Number of c-planes: 2

Candela at center: 144459 cd

ISO LUX DIAGRAM

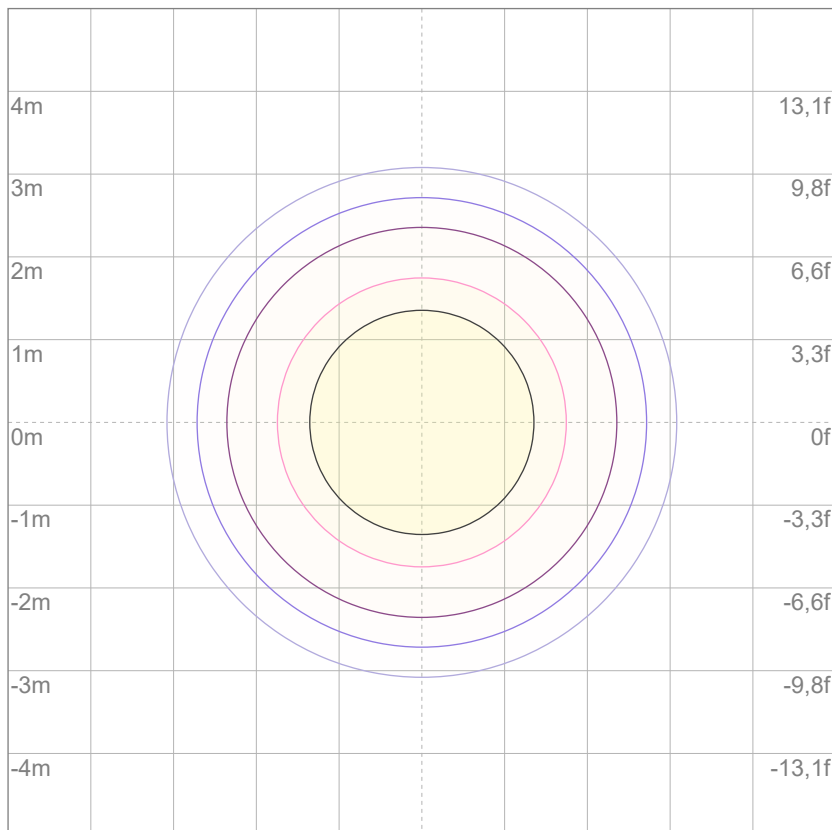

3%	43,3 lx
5%	72,2 lx
10%	144 lx
30%	433 lx
50%	722 lx

Conditions:

Number of c-planes: 2

Lux at center: 1445 lx

Lux distribution on a surface when lamp is mounted at 10 meters from the surface.

Mounting height: 10 meters (33 feet)